

**GAME BOY**<sup>®</sup>

*PROGRAMMING MANUAL*  
Version 1.0

“Confidential”

This document contains confidential and proprietary information of Nintendo and is also protected under the copyright laws of the United States and foreign countries. No part of this document may be released, distributed, transmitted or reproduced in any form or by any electronic or mechanical means, including information storage and retrieval systems, without permission in writing from Nintendo.

© 1999 Nintendo of America Inc.

TM and ® are trademarks of Nintendo

## INTRODUCTION

This manual is a combination and reorganization of the information presented in the Game Boy Development Manual, revision G, and the Game Boy Color User's Guide, version 1.3. In addition, it incorporates all information related to Game Boy programming, including programming for Super Game Boy and the Game Boy Pocket Printer.

The abbreviations used in this manual represent the following:

- DMG:** Game Boy (monochrome), introduced on April 21, 1989
- MGB:** Game Boy Pocket (monochrome), introduced on July 21, 1996
- MGL:** Game Boy Light (monochrome), introduced on April 14, 1998
- CGB:** Game Boy Color (color), introduced on October 21, 1998

**Note:** *Where it is not necessary to distinguish between the different monochrome models, DMG is used to refer to both monochrome models, and CGB is used to denote the color Game Boy. Only where it is necessary to distinguish between the monochrome models is MGB used to denote Game Boy and MGL used to denote Game Boy Light.*

- SGB:** Super Game Boy, introduced on June 14, 1994
- SGB2:** Super Game Boy 2, introduced on January 30, 1998

**Note:** *SGB is used to denote both SGB and SGB2 when no distinction is necessary. SGB2 is used only in cases where distinction is necessary.*

***THIS PAGE WAS INTENTIONALLY LEFT BLANK.***

## **PREFACE: TO PUBLISHERS**

### **NINTENDO GAME BOY COLOR SOFTWARE PRE-APPROVAL REQUIREMENTS**

Prior to submitting your CGB software to Lot Check for approval, it is required that you submit it to the Licensee Product Support Group for pre-approval. To assist us with the evaluation of your CGB software and/or product proposal(s), please refer to the following requirements when submitting materials\* for approval.

\* Please do not send original artwork or materials, as they will not be returned.

CGB software and/or product proposals are evaluated based on the following criteria:

- Use of Color

To ensure that the expectations of the Game Boy Color consumer are met, Mario Club will evaluate the use of color in all CGB games (dual or dedicated) using the following criteria:

- ◇ **Differentiation** - If a game is to be considered CGB-compatible, then it must appear significantly more colorful than a monochrome Game Boy game when “colorized” by the CGB hardware. The principal measure of this is the number of colors in the background (BG) and the number of colors in the objects (OBJ).
- ◇ **Simultaneous Colors** - Because CGB hardware automatically “colorizes” monochrome games with up to four colors in the BG palette and up to six colors for two OBJ palettes (three colors per palette), a game typically must display more colors than this automatic “colorization” to be considered a CGB game.
- ◇ **Appropriate use of Color** - Objects in the game that are based on reality (trees, rocks, animals, and so on) should be a color that we would normally associate with them. For fictional objects, colors should be chosen to show appropriate detail and, when needed, to differentiate unlike objects.
- ◇ **Variety of Colors** - The CGB is capable of producing a wide range of colors (32,768 to be exact -- albeit not all at the same time). A CGB game should use this capability of the hardware to yield distinctly different colors for objects, characters, areas, and so on.
- ◇ **Contrast & Saturation** - Two of the elements that make a game look colorful are high contrast and “saturated” or vibrant colors. Pastel colors on a white background will not seem nearly as colorful as the same colors on a dark background. Not every game can use a dark background, but the intensity of the colors should still be maximized as much as possible.

Please detail or demonstrate how your game will utilize color capabilities of the CGB. Use whatever means will best allow you to do so, such as artists renderings, programmed demos, ROM images, written descriptions, and so on.

## **Game Boy Programming Manual**

- Game Concept content

*We do not require an explanation of, or evaluate game concept content for original CGB titles. However, if you are planning to “colorize” a previously released monochrome game we require that it include game-play enhancements (beyond simply adding color) to differentiate it from its monochrome counterpart. Such game-play enhancements may include, but are not limited to: additional stages, levels, or areas; new characters; additional items; game-play based on color; and so on. These enhancements must be readily apparent to players familiar with the original monochrome game.*

Please submit a written proposal of the enhancements to us for pre-approval. Use whatever additional means that will best allow you to communicate the game-play enhancements, such as storyboards, treatments, videotapes, programmed demos, and so on.

- Interim ROM Submissions

We require at least one interim ROM submission to Mario Club (at approximately 50% completion) for preliminary review of the use of color in every CGB game. By reviewing the interim ROM and providing you with feedback in the early stages, we also help ensure that your projects stay on schedule. Final pre-approval is based on Mario Club's evaluation of a ROM near completion of game development.

*If you wish to arrange electronic transfer of the ROM image, please contact Sharon Pfeifle in our Testing and Engineering department at (425) 861-2768 or by e-mail at “sharpf01@noa.nintendo.com”. Please notify me when you have made an electronic submission for our review.*

- Proposed Developer

Please supply us with the name, address and phone number of the proposed developer. If the developer is not an Authorized Nintendo CGB Developer, please contact Lief Thompson at “liefth@noa.nintendo.com” or 425-861-2823, and he will provide you with the application information.

- Schedule Information

Please provide us with an estimated product schedule, including interim ROM submission(s), final Mario Club submission, submission of the master ROM to Lot Check, and the release date.

- Game Pak Configuration & Game Type

Please provide us with the estimated Game Pak size in Megabits (Mb) and the RAM size if internal memory is to be used to save game information. Also state whether the game will be compatible with the monochrome Game Boy hardware or if it is dedicated to CGB hardware. For the current Game Pak prices and configurations available, please contact Nintendo's Licensing Department.

You will be contacted with the evaluation results when the Licensee Product Support Group has completed its evaluation of your ROM or concept submission.

## Table of Contents

	<i>Page Number</i>
<b>Introduction.....</b>	<b>3</b>
<b>Preface: To Publishers .....</b>	<b>5</b>
<b>Chapter 1 System.....</b>	<b>10</b>
<b>Chapter 2 Display Functions.....</b>	<b>46</b>
<b>Chapter 3 Sound Functions .....</b>	<b>70</b>
<b>Chapter 4 CPU Instruction Set.....</b>	<b>84</b>
<b>Chapter 5 Miscellaneous General Information .....</b>	<b>114</b>
<b>Chapter 6 The Super Game Boy System .....</b>	<b>124</b>
<b>Chapter 7 Super Game Boy Sound .....</b>	<b>182</b>
<b>Chapter 8 Game Boy Memory Controllers(MBC).....</b>	<b>212</b>
<b>Chapter 9 Pocket Printer .....</b>	<b>233</b>
<b>Appendix 1 Programming Cautions.....</b>	<b>248</b>
<b>Appendix 2 Register and Instruction Set Summaries.....</b>	<b>260</b>
<b>Appendix 3 Software Submission Requirements.....</b>	<b>276</b>

***THIS PAGE WAS INTENTIONALLY LEFT BLANK.***



<b>CHAPTER 1: SYSTEM .....</b>	<b>10</b>
<b>1. General System .....</b>	<b>10</b>
1.1 System Overview .....	10
1.2 Game Boy Block Diagram .....	12
1.3 Memory Configuration.....	13
1.4 Memory Map.....	14
1.5 Feature Comparison .....	15
1.6 Register Comparison.....	16
<b>2. CPU .....</b>	<b>17</b>
2.1 Overview of CPU Features .....	17
2.2 CPU Block Diagram .....	19
2.3 Description of CPU Functions .....	21
2.4 CPU Functions (Common to DMG/CGB <sup>①</sup> ).....	23
2.5 CPU Functions (Common to DMG/CBG <sup>②</sup> ).....	28
2.6 CPU Functions (CGB only).....	34

## CHAPTER 1: SYSTEM

### 1. GENERAL SYSTEM INFORMATION

#### 1.1 System Overview

##### Structure

At the heart of the DMG/CGB system is a CPU with a built-in LCD controller designed for DMG/CGB use.

##### System

[DMG]	[CGB]
<ul style="list-style-type: none"><li>➤ Dot-matrix LCD unit capable of grayscale display</li><li>➤ 64 Kbit – SRAM (for LCD display)</li><li>➤ 64 Kbit – SRAM (working memory)</li></ul>	<ul style="list-style-type: none"><li>➤ Color dot-matrix LCD unit capable of RGB with 32 grayscale shades</li><li>➤ 128 Kbit – SRAM (for LCD display)</li><li>➤ 256 Kbit – SRAM (working memory)</li><li>➤ Infrared communication link (photo transistor, photo LED)</li></ul>

##### Features common to DMG/CGB

- 32-pin connector (for ROM cartridge connection)
- 6-pin subconnector (for external serial communication)
- DC-DC converter for power source
- Sound amp
- Keys for operation
- Speaker
- Stereo headphone connector
- Input connector for external power source

##### Types of Game Pak Supported

- 1 Game Boy Game Pak  
(Software that uses only the Game Boy functions. When used with Game Boy Color, 4-10 colors are displayed.)
- 2 Game Boy Color Game Pak
  - Game Pak supported by CGB (for use with both CGB and DMG)
  - Game Pak for CGB only (software that runs only on CGB)

##### Operating Modes (the following modes apply only to CGB)

- 1 DMG Mode (when using software for DMG)  
The new registers, expanded memory area, and new features for CGB are not used. Color applications previously associated with palette data BGP, OBP0, and OBP1 are performed by the system.

- 2 CGB Mode (when using software supported or used exclusively by CGB )  
The new registers, expanded memory area, and new features of CGB are available.

**Note**      *To operate in CGB mode, specific code must first be placed in the ROM data area of the user program. For more information, see Chapter 5, Section 2, Recognition of CGB support (CGB only) in ROM Data.*

**Power Source**

- Battery/AC adapter/Battery charger

**Accessories (as of April 1999)**

DMG Accessories

- Communication Cable
- Battery Charger Adapter

MGB/CGB Accessories

- Communication Cable
- AC Adapter
- Battery Pack Charger Set

The 6-pin serial communication subconnector and the AC adapter input connector of the DMG hardware that preceded MGB are shaped differently than those of MGB and CGB. Thus, two types of accessories are available — those exclusively for DMG and those exclusively for MGB/CGB. In addition, a conversion connector is necessary for communication between DMG and MGB/CGB.

## 1.2 GAME BOY BLOCK DIAGRAM

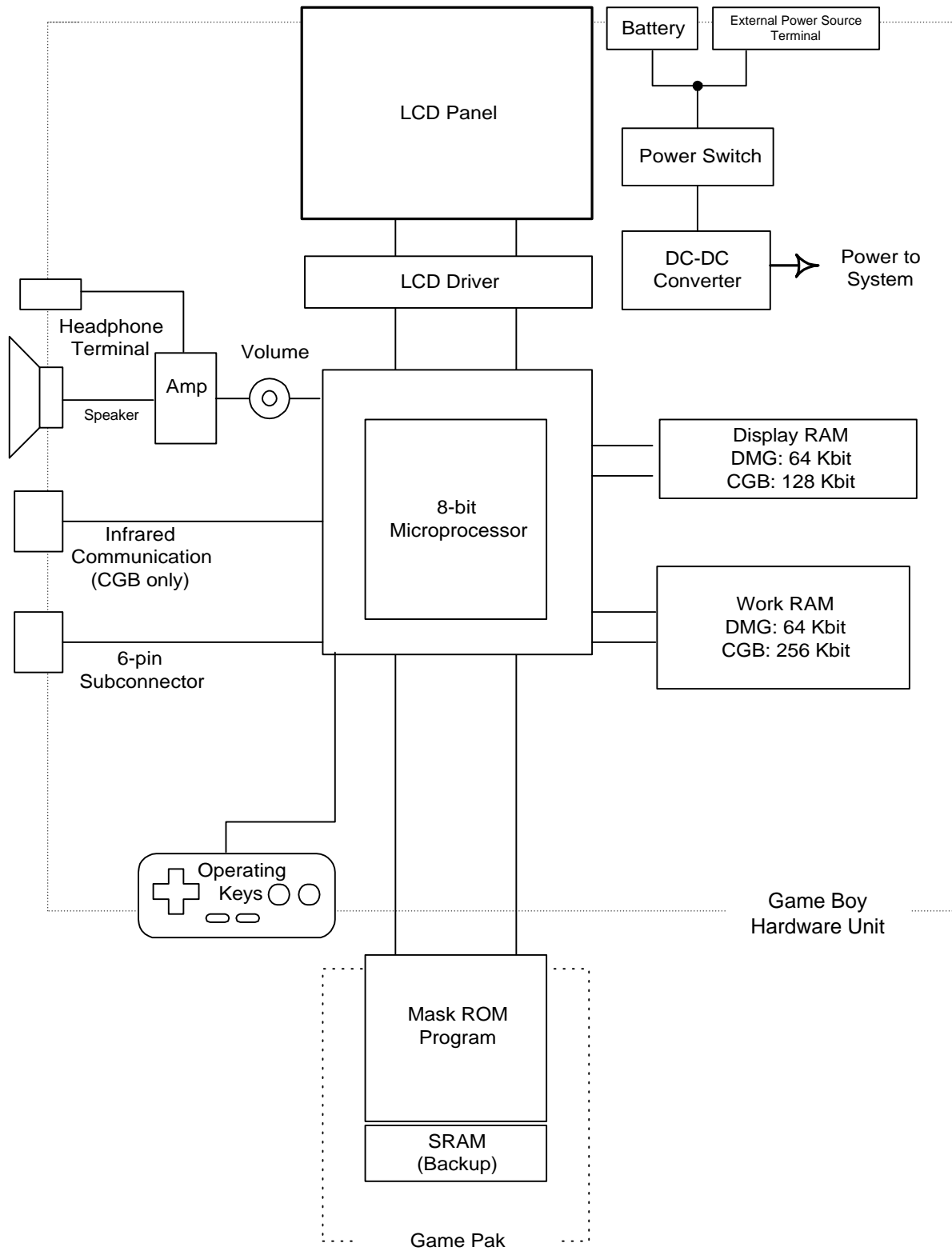

## 1.3 MEMORY CONFIGURATION

In DMG and CGB, the 32 KB from 0x0 to 0x7FFF is available as program area.

0x000-0x0FF: Allocated as the destination address for RST instructions and the starting address for interrupts.

0x100-0x14F: Allocated as the ROM area for storing data such as the name of the game.

0x150: Allocated as the starting address of the user program.

The 8 KB from 0x8000 to 0x9FFF is used as RAM for the LCD display. In CGB, the amount of RAM allocated for this purpose is 16 KB (8 KB x 2), twice the amount allocated for the LCD display in DMG, and this RAM can be used in 8 KB units using bank switching. The 8 KB RAM areas are divided into the following 2 areas.

- 1 An area for character data
- 2 An area for BG (background) display data (Character code and attribute)

The 8 KB from 0xA000 to 0xBFFF is the area allocated for external expansion RAM.

The 8 KB from 0xC000 to 0xDFFF is the work RAM area.

In DMG, the 8 KB of working RAM is implemented without change. In CGB, bank switching is used to provide 32 KB of working RAM. This 32 KB area is divided into 8 areas of 4 KB each.

- 1 The 4 KB from 0xC000 to 0xCFFF is fixed as Bank 0.
- 2 The 4 KB from 0xD000 to 0xDFFF can be switched between banks 1 through 7.

<b>Note</b> <i>Use of the area from 0xE000 to 0xFDFF is prohibited.</i>
---

0xFE00 to 0xFFFF is allocated for CPU internal RAM.

0xFE00-0xFE9F: OAM-RAM (Holds display data for 40 objects)

0xFF00-0xFF7F & 0xFFFF: Specified for purposes such as instruction registers and system controller flags.

0xFF80-0xFFFFE: Can be used as CPU work RAM and/or stack RAM.

## 1.4 MEMORY MAP

**Note** In DMG, there is no bank switching at 0x8000-0x9FFF and 0xC000-0xDFFF.

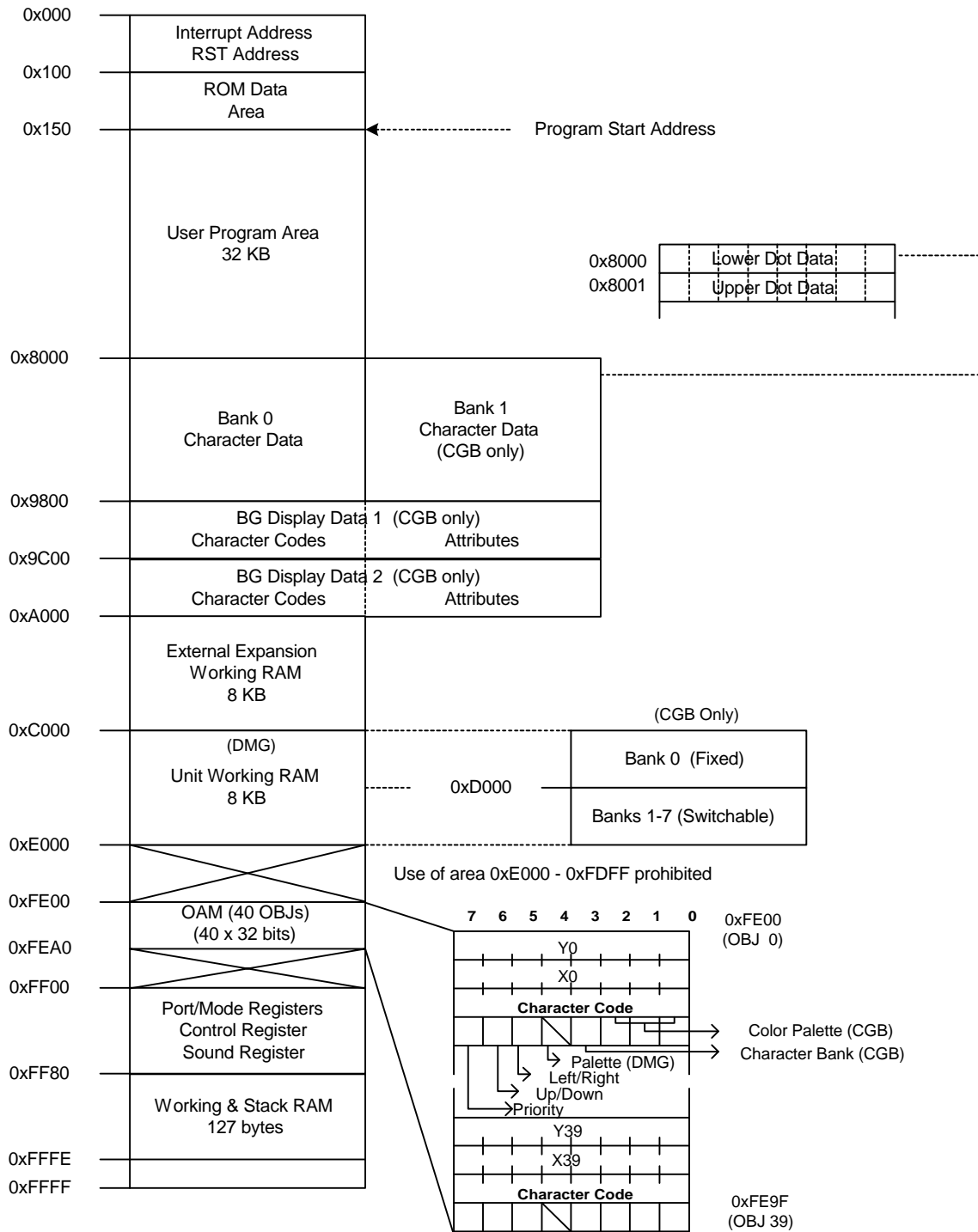

## 1.5 FEATURE COMPARISON

Item	DMG CPU	CGB CPU
<b>CPU Speed</b> (system operating frequency)	1.05 MHz	1.05 MHz (normal mode) 2.10 MHz (double-speed mode)
<b>Game Boy RAM</b> Work and Stack RAM Work RAM OAM For LCD display	127 x 8 bits 8,192 bytes 40 x 28 bits 8,192 bytes	← 32,768 bytes 40 x 32 bits 16,384 bytes
<b>Game Pak Memory Space</b> ROM (without MBC) RAM (without MBC)	32,768 bytes 8,192 bytes	← ←
<b>LCD Controller</b> Display Capacity Block Structure BG, window Object Number of Usable Characters BG OBJ 8 x 8 8 x 16 Grayscale: BG, window  Grayscale: Object  Object priority Different x coordinates  Same x coordinates	160 x 144 dots  8 x 8 dots 8 x 8 dots or 8 x 16 dots  256 256 128 4 shades, 1 palette  3 shades, 2 palettes  Object with smallest x coord .  Object with lowest OBJ number	160 x 144 x RGB dots  ← ←  512 512 256 4 colors, 8 palettes ( DMG mode: 4 colors, 1 palette) 3 colors, 8 palettes (DMG mode: 3 colors, 2 palettes)  Object with lowest OBJ number (DMG mode: Object with lowest x coord.)  ←
<b>Timer &amp; Divider Stages</b>	8-bit timer x 1 16 stages x 1	← ←
<b>Serial Input/Output</b> Baud Rate	8 bits x 1 8 K	← 8K/256K (16K/512K in high-speed mode)
<b>DMA Controller</b> Existing DMA Horizontal blank DMA General-purpose DMA	0x8000~0xDFFF→OAM --- ---	0x0~0xDFFF→OAM Game Pak & Work RAM→VRAM Game Pak & Work RAM→VRAM
<b>Interrupt features</b> Internal Interrupts External Interrupts	4 types (maskable) 1 type (maskable)	← ←
<b>Input/Output Ports</b> Serial Input/Output Ports Infrared Communication Port	SIN, SCK, SOUT ---	← R0, R1, R2, R3
<b>Sound Output Circuit</b>	4 sounds	← Monaural (VIN) External Sound Mixable Input

←: Same as in column at left

## 1.6 REGISTER COMPARISON

Use	DMG CPU		CGB CPU	
	Register	Address	Register	Address
Port/Mode Registers	P1	FF00	←	←
	SB	FF01	←	←
	SC	FF02	←	←
	DIV	FF04	←	←
	TIMA	FF05	←	←
	TMA	FF06	←	←
	TAC	FF07	←	←
	---	---	KEY1	FF4D
	---	---	RP	FF56
	Bank Control Registers		---	VBK
		---	SVBK	FF70
Interrupt Flags	IF	FF0F	←	←
	IE	FFFF	←	←
	IME		←	
LCD Display Registers	LCDC	FF40	←	←
	STAT	FF41	←	←
	SCY	FF42	←	←
	SCX	FF43	←	←
	LY	FF44	←	←
	LYC	FF45	←	←
	DMA	FF46	←	←
	BGP	FF47	←	←
	OBP0	FF48	←	←
	OBP1	FF49	←	←
	WY	FF4A	←	←
	WX	FF4B	←	←
		---	HDMA1	FF51
		---	HDMA2	FF52
		---	HDMA3	FF53
		---	HDMA4	FF54
		---	HDMA5	FF55
		---	BCPS	FF68
		---	BCPD	FF69
		---	OCPS	FF6A
		---	OCPD	FF6B
		OAM	FE00~FE9F	←
Sound Registers	NR x x	FF10~FF26	←	←
	Waveform RAM	FF30~FF3F	←	←

←: Same as in column at left



## 2. CPU

### 2.1 OVERVIEW OF CPU FEATURES

The CPUs of DMG and CGB are ICs customized for DMG/CGB use, and have the following features.

#### **CPU Features**

Central to the 8-bit CPU are the following features, including an I/O port and timer.

- 127 x 8 bits of built-in RAM (working and stack)
- RAM for LCD Display: <DMG> 8 KB/<CGB>16 KB ( )
- Working RAM: <DMG> 8KB/<CGB> 32 KB
- Built-in 16-stage Frequency Divider
- Built-in 8-bit Timer
- 4 types of Internal Interrupts (maskable)
- 1 type of External Interrupt (maskable)
- Built-in DMA Controller
- Input Ports P10 ~ P13
- Output Ports P14 and P15
- Serial I/O Ports SIN, SCK, SOUT
- Infrared I/O Port <CGB only>

#### **LCD Controller Functions**

Game Boy is equipped with functions that provide control of the images displayed on the LCD. Character data used for display is held in system RAM.

- DMG: 4 shades of gray; CGB: 32 shades of gray for each RGB color
- 160 x 144-dot liquid crystal display
- 8 x 8-dot composition of background and window characters
- 8 x 8 or 8 x 16-dot composition of OBJ characters
- Up to 40 objects displayable in 1 screen
- Up to 10 objects displayable on 1 horizontal line
- 40 x 32 bits of built-in RAM (OBJ-RAM for LCD)
- Control of 256 x 256-dot background
- Vertically and horizontally scrollable background
- Window-like functions

#### **Sound Functions**

Each system is equipped with 4 types of sound synthesis circuitry.

- Sound 1: Quadrangular waveform, sweep and envelope functions
- Sound 2: Quadrangular waveform, envelope functions
- Sound 3: Arbitrary waveform, generated
- Sound 4: White noise, generated
- 2 output channels (output can be allocated to a channel)
- Synthesized output with external sound input <CGB only>

***Miscellaneous***

- An internal monitor program is built into DMG/CGB CPUs. When power is turned on or the Game Boy is reset, the internal monitor program first initializes components such as the ports, then passes control to the user program.
- Instruction cycles
  - <DMG> 0.954  $\mu$ s (source oscillation: 4.1943 MHz)
  - <CGB> 0.954  $\mu$ s/0.477  $\mu$ s, switchable (source oscillation: 8.3886 MHz)

## 2.2 CPU BLOCK DIAGRAM

### Game Boy (DMG/MGB) CPU

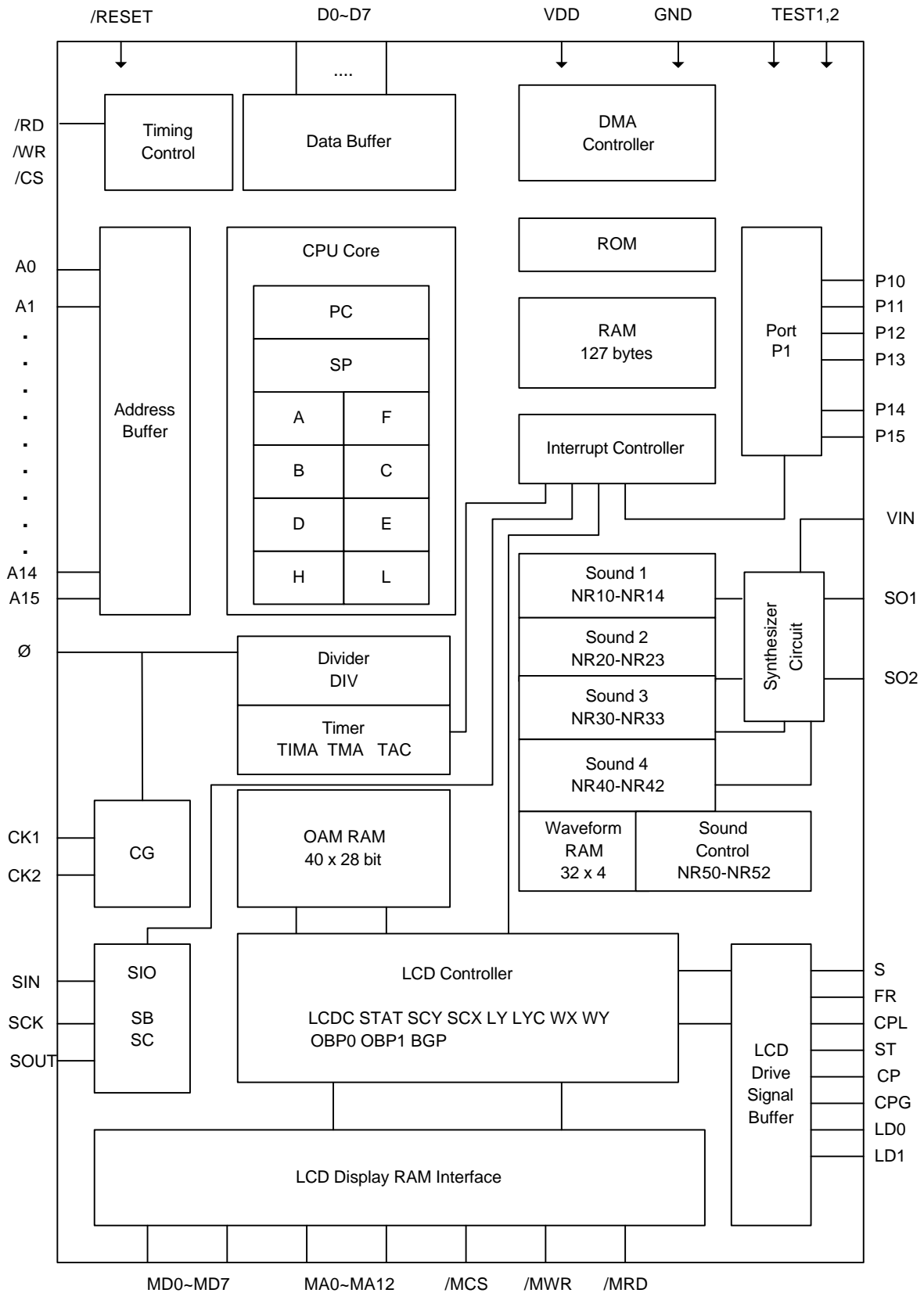

**Game Boy Color CPU**

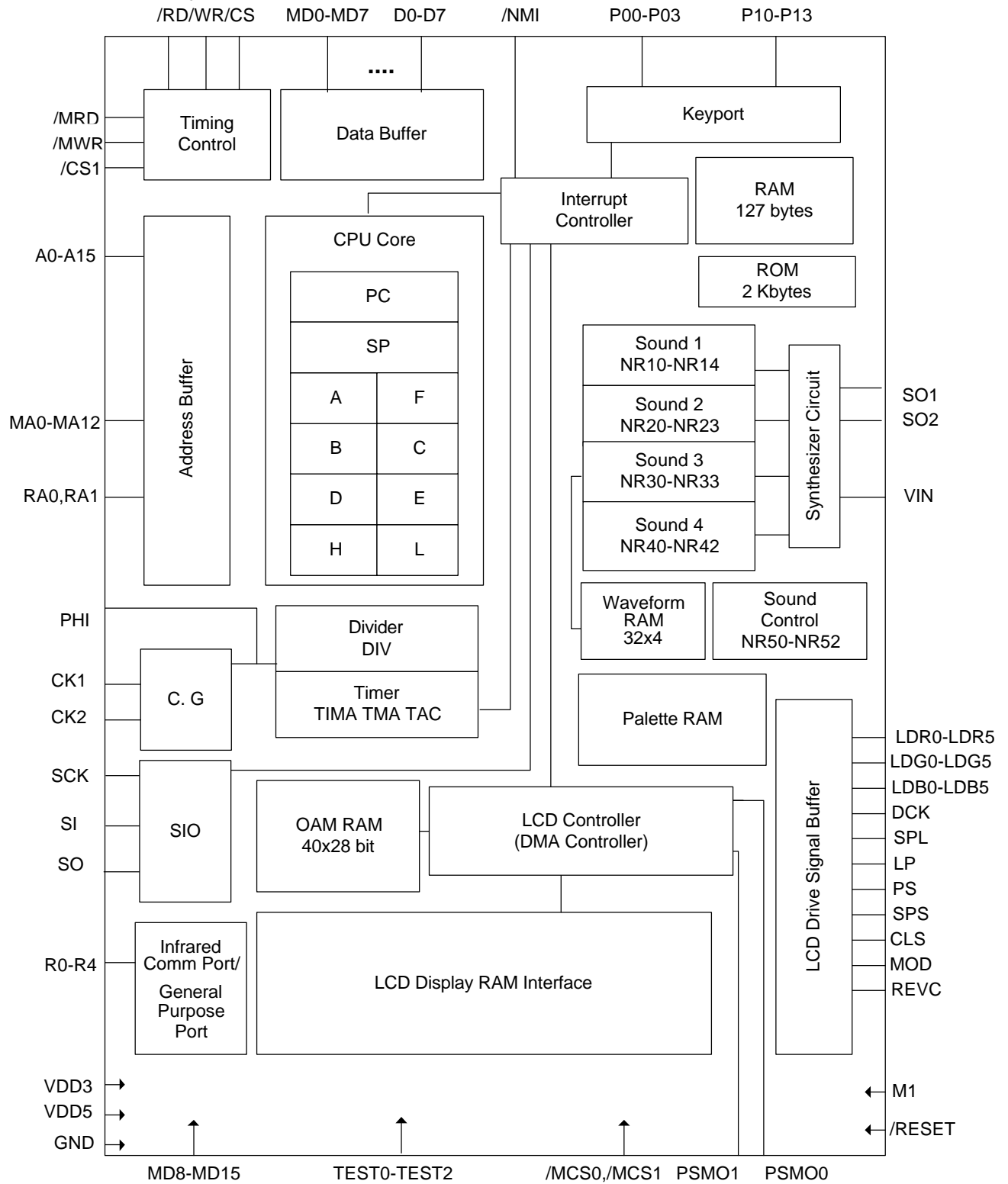

## 2.3 DESCRIPTION OF CPU FUNCTIONS

### **Interrupts**

There are five types of interrupts available, including 4 types of maskable internal interrupts and 1 type of maskable external interrupt. The IE flag is used to control interrupts. The IF flag indicates which type of interrupt is set.

- LCD Display Vertical Blanking
- Status Interrupts from LCDC (4 modes)
- Timer Overflow Interrupt
- Serial Transfer Completion Interrupt
- End of Input Signal for ports P10-P13

### **DMA Transfers**

DMA transfers are controlled by the DMA registers.

<DMG>

DMG allows 40 x 32-bit DMA transfers from 0x8000-0xDFFF to OAM (0xFE00-0xFE9F). The transfer start address can be specified in increments of 0x100 for 0x8000-0xDFFF.

<CGB>

In addition to the DMA transfers method for DMG (from 0x0000-0xDFFF in CGB), CGB enables two new types of DMA transfer — horizontal blanking and general-purpose DMA transfers.

Note, however, that when performing a DMG-type DMA transfer on CGB, some consideration must be given to specifying the destination RAM area.

For more information, see the DMA Functions section in Chapter 2.

#### 1 Horizontal Blanking DMA Transfer

Sixteen bytes of data are automatically transferred for each horizontal blanking period during a DMA transfer from the user program area (0x0000-0x7FFF) or external and hardware working RAM area (0xA000-0xDFFF) to the LCD display RAM area (0x8000-0x9FFF).

#### 2 General-Purpose DMA Transfer

Between 16 and 2048 bytes of data (specified in 16-byte increments) are transferred from the user program area (0x0000-0x7FFF) or external and hardware working RAM area (0xA000-0xDFFF) to the LCD display RAM area (0x8000-0x9FFF), during the Vertical Blanking Period.

### **Timer**

The timer is composed of the following:

- TIMA (timer counter)
- TMA (timer modulo register)
- TAC (timer control register)

### **Controller Connections**

- P10-P13: Input ports
- P14-P15: The key matrix structure is composed of the output ports.

At user program startup, the status of the CPU port registers and mode registers are as follows.

Register	Status
P1	0
SC	0
TIMA	0
TAC	0
IE	0
LCDC	\$83 BG/OBJ ON, LCDC OPERATION
SCY	0
SCX	0
LYC	0
WY	0
W	0
Interrupt Enable (IE)	DI

Stack: 0xFFFFE

### **Standby Modes**

The standby functions are HALT mode, which halts the system clock, and STOP mode, which halts oscillation (source oscillation).

#### **HALT Mode**

Game Boy switches to HALT mode when a HALT instruction is executed.

The system clock and CPU operation halt in this mode. However, operation of source oscillation circuitry between terminals CK1 and CK2 continues. Thus, the functions that do not require the system clock (e.g., DIV, SIO, timer, LCD controller, and sound circuit) continue to operate in this mode.

HALT mode is canceled by the following events, which have the starting addresses indicated.

- 1) A LOW signal to the /RESET terminal  
Starting address: 0x0000
- 2) The interrupt-enable flag and its corresponding interrupt request flag are set  
IME = 0 (Interrupt Master Enable flag disabled)  
Starting address: address following that of the HALT instruction  
IME = 1 (Interrupt Master Enable flag enabled)  
Starting address: each interrupt starting address

#### **STOP Mode**

Game Boy switches to STOP mode when a STOP instruction is executed.

The system clock and oscillation circuitry between the CK1 and CK2 terminals are halted in this mode. Thus, all operation is halted except that of the SIO external clock. STOP mode is canceled by the following events, and started from the starting address.

- 3) A LOW signal to the /RESET terminal  
Starting address: 0x0000
- 4) A LOW signal to terminal P10, P11, P12, or P13  
Starting address: address following that of STOP instruction

When STOP mode is canceled, the system clock is restored after  $2^{17}$  times the oscillation clock (DMG: 4 MHz, CGB: 4 MHz/8 MHz), and the CPU resumes operation.

When STOP mode is entered, the STOP instruction should be executed after all interrupt-enable flags are reset, and meanwhile, terminals P10-P13 are all in a HIGH period.

## 2.4 CPU FUNCTIONS (COMMON TO DMG/CGB①)

The CPU functions described here are those that are identical in DMG and CGB. CPU functions that are enhanced in CGB are described in Section 2.5, *CPU Functions (Common to DMG/CGB②)*. CPU functions that cannot be used for DMG are described in Section 2.6, *CPU Function (CGB only)*.

### 2.4.1 Controller Data

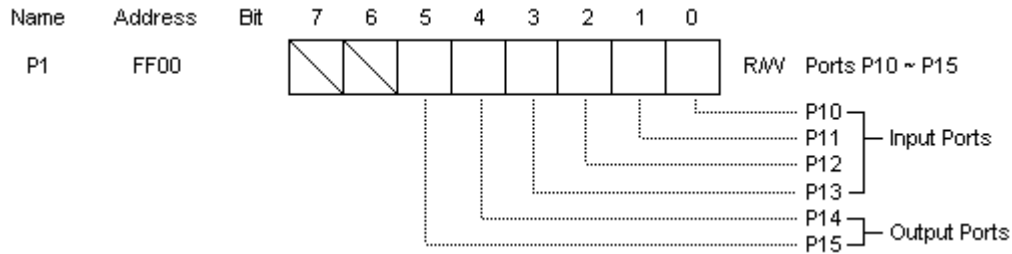

The P1 ports are connected with a matrix for reading key operations.

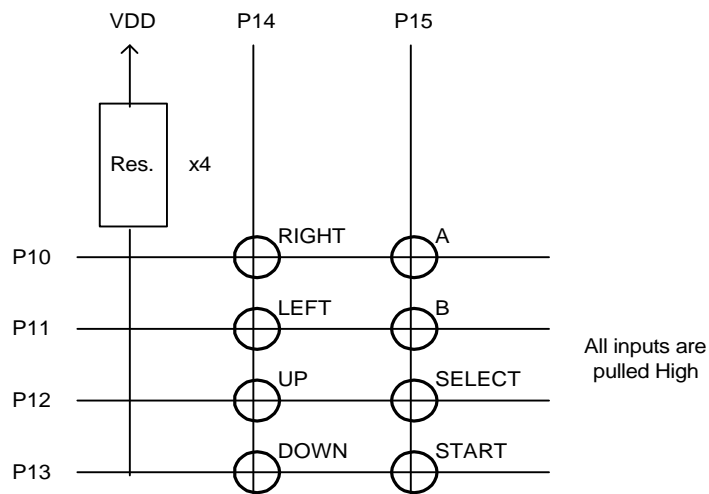

When key input is read, a brief interval is interposed between P14 and P15 output and reading of the input, as shown below.

```

Example: KEY      LD      A, $20          ; Read U, D, L, R keys
                  LD      ($FF00), A      ; Port P14 ← LOW output
                  LD      A, ($FF00)     ; Register A ← Port P10-P13
                  LD      A, ($FF00)     ; Perform this operation twice
                  .
                  .
                  LD      A, ($10)       ; Reads keys A, B, SE, ST
                  LD      ($FF00), A     ; Port P15 ← LOW output

                  LD      A, ($FF00)     ; Register A ← Ports P10-P13
                  LD      A, ($FF00)     ; Perform this operation 6 times
                  LD      A, ($FF00)     ;
                  .
                  .
                  LD      A, $30         ; Port reset
                  LD      ($FF00), A
                  .
                  RET
    
```

The interrupt request flag (IF: 4) is set by negative edge input at one of the P13-P10 terminals. Negative edge input requires a LOW period of  $2^4$  times source oscillation (DMG = 4 MHz, CGB = 4 MHz/8 MHz).

The interrupt request flag (IF: 4) also is set when a reset signal is input to the /RESET terminal with a P13~P10 terminal in the LOW state.

### 2.4.2 Divider Registers

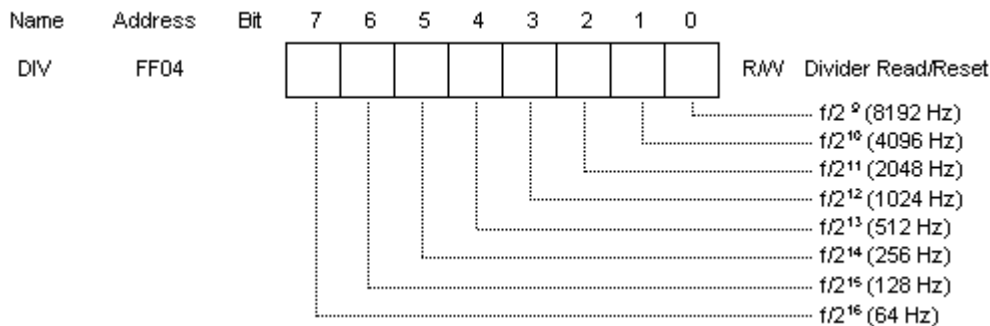

The upper 8 bits of the 16-bit counter that counts the basic clock frequency (f) can be referenced. If an LD instruction is executed, these bits are cleared to 0 regardless of the value being written.  $f = (4.194304 \text{ MHz})$ .



### 2.4.3 Timer Registers

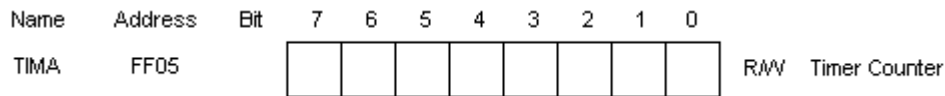

The main timer unit. Generates an interrupt when it overflows.

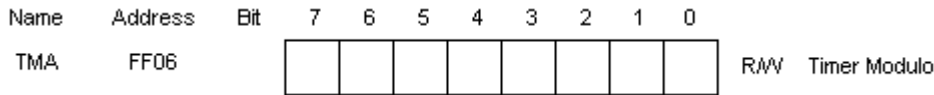

The value of TMA is loaded when TIMA overflows.

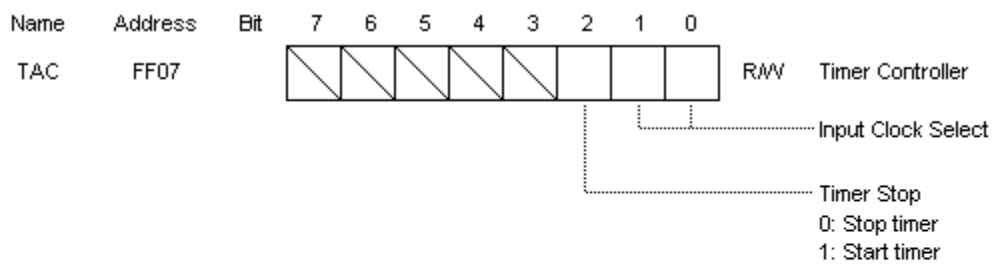

The timer consists of TIMA, TMA, and TAC.

The timer input clock is selected by TAC.

TIMA is the timer itself and operates using the clock selected by TAC.

TMA is the modulo register of TIMA. When TIMA overflows, the TMA data is loaded into TIMA.

Writing 1 to the 2<sup>nd</sup> bit of TAC starts the timer.

The timer should be started (the TAC start flag set) after the count up pulse is selected. Starting the timer before or at the same time as the count up pulse is selected may result in excessive count up operation.

#### Example

```

LD    A, 3          ;Select a count pulse of f/28
LD    (07), A      ;TAC ← 3 set
LD    A, 7          ;Start timer
LD    (07), A      ;
  
```

If a TMA write is executed with the same timing as that with which the contents of the modulo register TMA are transferred to TIMA as the result of a timer overflow, the same data is transferred to TIMA.

### 2.4.4 Interrupt Flags

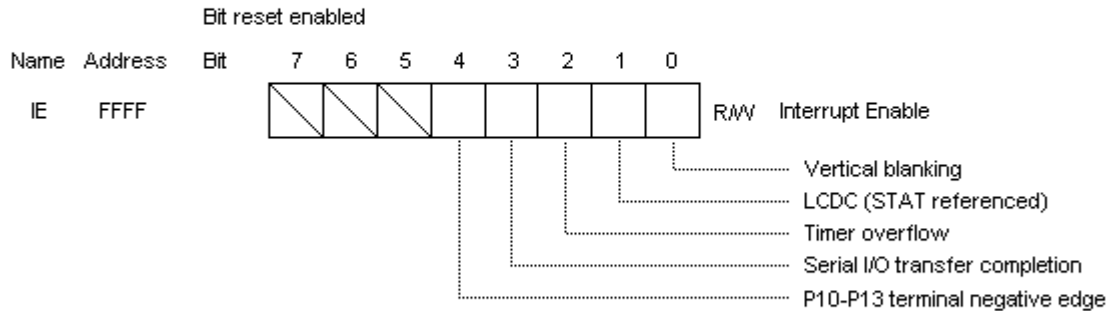
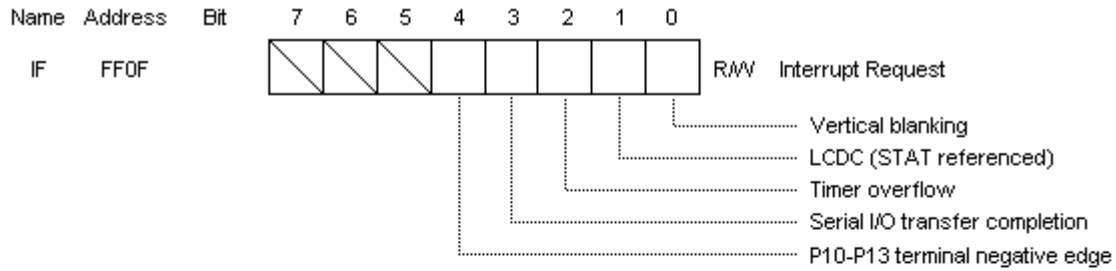

0: Disabled  
1: Enabled

Name  
IME  
Interrupt Master Enable  
0: Reset by DI instruction; prohibits all interrupts.  
1: Set by EI instruction; the interrupt set by the IE registers are enabled.

Bit reset enabled

Interrupts are controlled by the IE (interrupt enable) flag.  
The IF (interrupt request) flag can be used to determine which interrupt was requested.

The 5 types of interrupts are as follows.

Cause of Interrupt	Priority	Interrupt starting address
Vertical blanking	1	0x0040
LCDC status interrupt	2	0x0048
Timer overflow	3	0x0050
Serial transfer completion	4	0x0058
P10-P13 input signal goes low	5	0x0060

The LCDC interrupt mode can be selected (see STAT register),

- Mode 00
- Mode 01
- Mode 10
- LYC=LY consist

When multiple interrupts occur simultaneously, the IE flag of each is set, but only that with the highest priority is started. Those with lower priorities are suspended.

When using an interrupt, set the IF register to 0 before setting the IE register.

The interrupt process is as follows:

- 1 When an interrupt is processed, the corresponding IF flag is set.
- 2 Interrupt enabled.  
If the IME flag (Interrupt Master Enable) and the corresponding IE flag are set, the interrupt is performed by the following steps.
- 3 The IME flag is reset, and all interrupts are prohibited.
- 4 The contents of the PC (program counter) are pushed onto the stack RAM.
- 5 Control jumps to the interrupt starting address of the interrupt.

The resetting of the IF register that initiates the interrupt is a hardware reset.

The interrupt processing routine should push the registers during interrupt processing.

When an interrupt begins, all other interrupts are prohibited, but processing of the highest level interrupt is enabled by controlling the IME and IE flags with instructions.

Return from the interrupt routine is performed by the RETI and RET instructions.

If the RETI instruction is used for the return, the IME flag is automatically set even if a DI instruction is executed in the interrupt processing routine.

If the RET instruction is used for the return, the IME flag remains reset unless an EI instruction is executed in the interrupt routine.

Each interrupt request flag of the IF register can be individually tested using instructions.

Interrupts are accepted during the op code fetch cycle of each instruction.

## 2.5 CPU FUNCTIONS (COMMON TO DMG/CGB®)

This section describes the CPU functions that have been enhanced in CGB. Functions that are identical in DMG and CGB are described in Section 2.4, *CPU Functions (Common to DMG/CGB®)*. CPU functions not available in DMG are described in Section 2.6, *CPU Functions (CGB only)*.

### 2.5.1 Serial Cable Communication

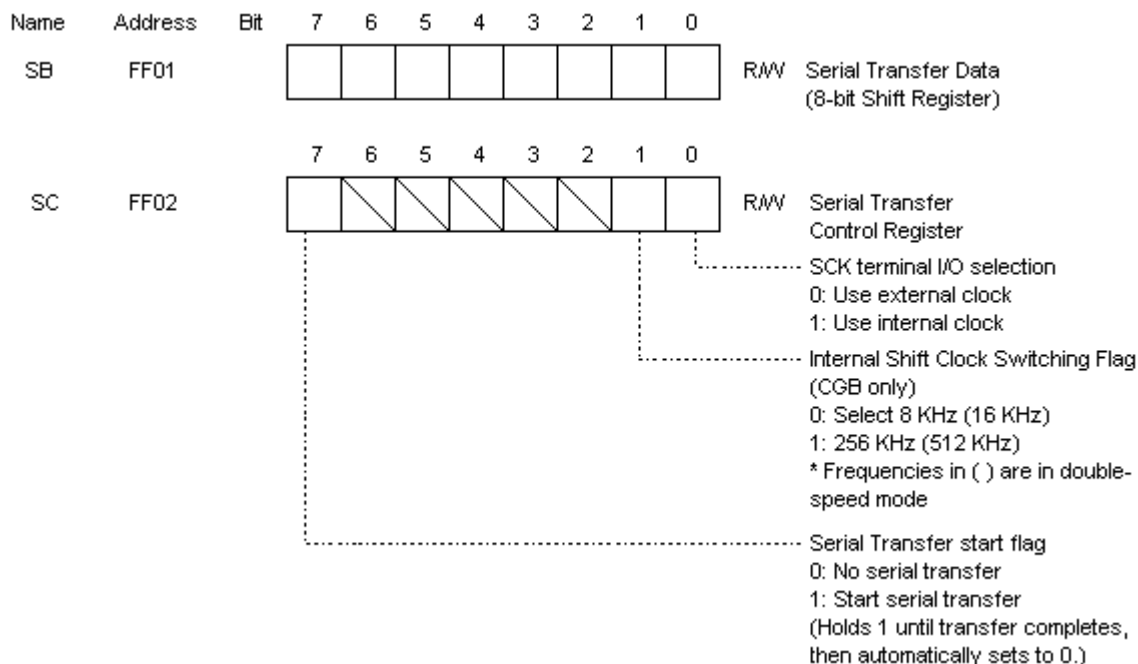

**Note** In DMG mode, bit 1 of the SC register is set to 1 and cannot be changed, but the transfer speed is fixed at 8 KHz.

Serial I/O (SIO) is controlled by the SB and SC registers.

The lowest bit (SC0) of the SC register can be used to select shift clock to be either the external clock from the SCK terminal or the internal shift clock.

Sending and receiving occur simultaneously with a serial transfer.

If the data to be sent is set in the SB register and the serial transfer is then started, the received data is set in the SB register when the transfer is finished.

Serial transfer procedure:

- 1 The data is set in the SB register.
- 2 Setting the highest SC register bit (SC 7) to 1 starts the transfer.
- 3 The 3-bit counter is reset and after 8 counts of the shift clock, the transfer is performed until overflow occurs.
- 4 SC7 is reset.
- 5 If the serial transfer completion interrupt is enabled, the CPU is interrupted.

When the shift clock goes low, the contents of the SB register are shifted leftward and the data is output from the highest bit. When the shift clock goes high, input data from the SIN terminal are output to the lowest bit of the SB register.

When the SCK terminal is in external-clock mode, it is pulled up to VDD.

If the highest bit of the SC register (SC7) is set, reading and writing to the SB register is prohibited.

An SIO serial transfer should be started (highest SC bit set) after the external or internal shift clock is selected. Excessive shifting may result if the transfer is started before or at the same time as the shift clock is selected.

If a transfer is performed using the external clock, the data is first set in the SB register, then the SC register start flag is set and input from the external clock is awaited. The transfer start flag must be set each time data is transferred.

The maximum setting for an external clock is 500 KHz.

Serial communication (SIO) specifications are essentially the same for DMG and CGB. In CGB, however, the operating speed of the internal shift clock can be set to high by specifying a speed in bit 1.

SIO Timing Chart

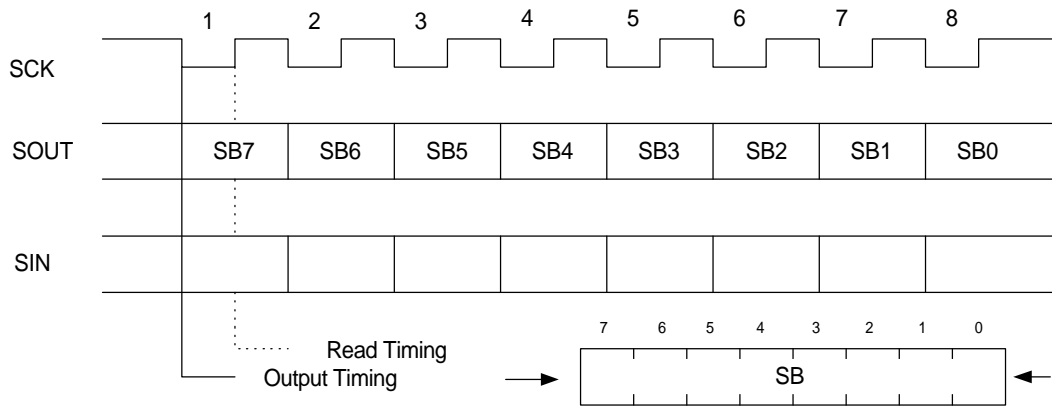

SIO Block Diagram

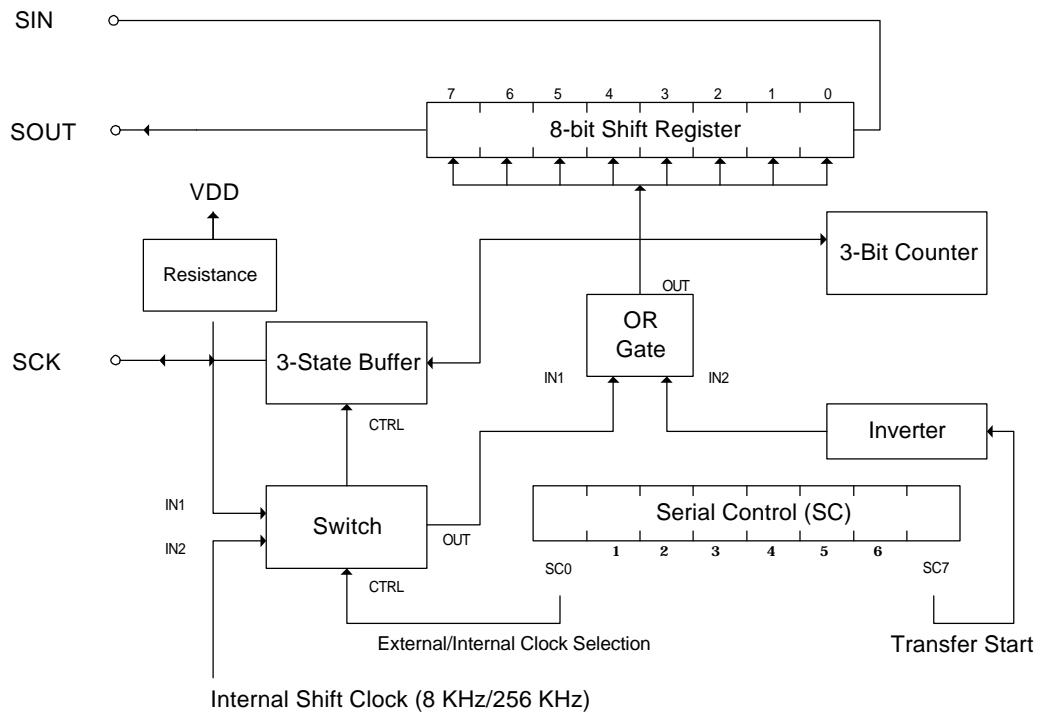

2.5.2 Serial Cable Communication: Reference flowchart

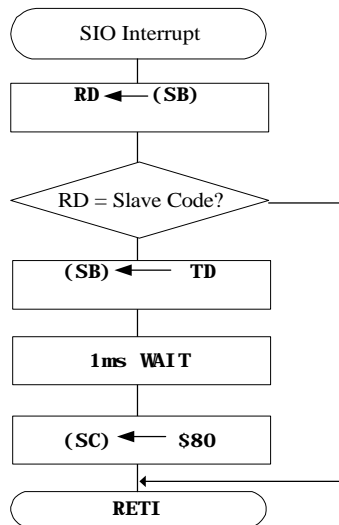
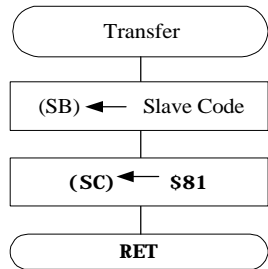
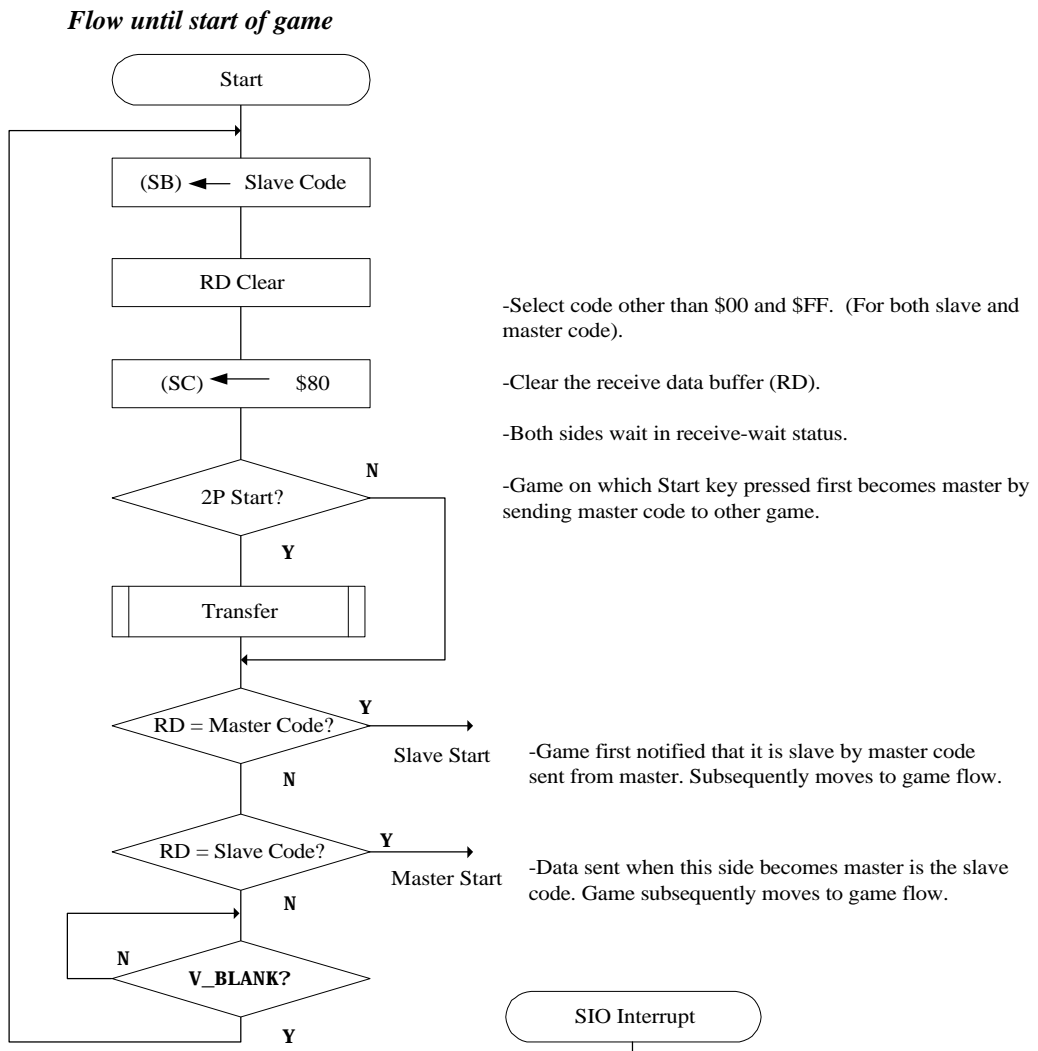

TD: Transfer Data Buffer

Timing of receive synchronized with Power Up.

*Flow after game start*

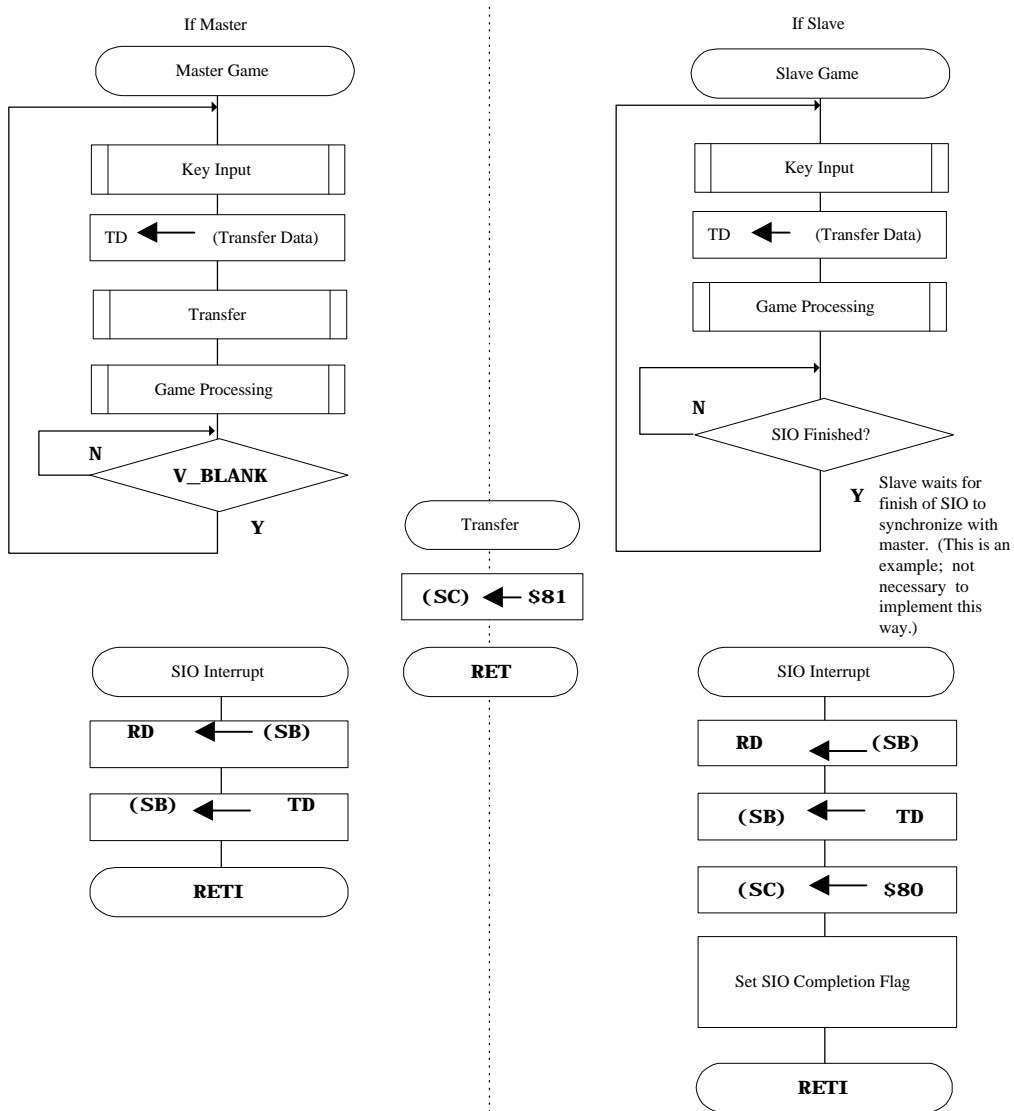

Data subsequently sent by the master is placed in (SB) and then sent to the slave at the same time as the (SC) is set to \$81. At exactly that same time, the master receives the slave data. An SIO interrupt is then set in the slave and, as the flowchart indicates, the slave sets the data to be sent to the master (current data).

Because the data sent from the slave are those loaded at the time of the previous interrupt, the data sent to the master are one step (one pass through the main program) behind the current slave data. Exactly the converse is true when this process is viewed



from the perspective of the slave. An SIO interrupt is set in the master, and the master sets the data to be sent to the slave (current data). In this case, because the data sent from the master are those loaded at the time of the previous interrupt, the data sent to slave are one step (one pass through main program) behind the current master data. (\*The data of the master and slave can be synchronized by setting the data for each back 1 pass.)

In the example, 1 byte is sent per frame. (This is not required.) If several bytes are sent continuously, a transmission interval longer than the processing time of other interrupts (e.g. V\_BLANK) should be used (usually around 1 mS). The reason is that if an attempt is made to communicate with the slave during another interrupt, the slave cannot receive the data until after the interrupt is finished. If the next data is transmitted before the other interrupt is finished, the slave will be unable to receive the initial data of the transmission.

## 2.6 CPU FUNCTIONS (CGB ONLY)

This section describes CPU functions that can be used only with CGB. Functions that are identical in DMG and CGB are described in Section 2.4, *CPU Functions (Common to DMG/CGB①)*. For information on CPU functions enhanced in CGB, see Section 2.5, *CPU Functions (Common to DMG/CGB②)*.

### 2.6.1 Bank Register for Game Boy Working RAM

The 32 KB of Game Boy working RAM is divided into 8 banks of 4 KB each. The CPU memory space 0xC000-0xCFFF is set to Bank 0, and the space 0xD000-0xDFFF is switched between banks 1-7. Switching is performed using the lowest 3 bits of the bank register, SVBK. (If 0 is specified, Bank 1 is selected.)

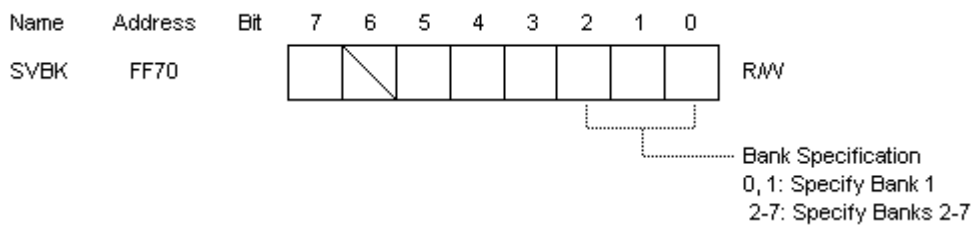

**Note** This register cannot be written to in DMG mode.

### 2.6.2 CPU Operating Speed

The speed of the CGB CPU can be changed to suit different purposes. In normal mode, each block operates at the same speed as with the DMG CPU. In double-speed mode, all blocks except the liquid crystal control circuit and the sound circuit operate at twice normal speed.

Normal mode: 1.05 MHz (CPU system clock)

Double-speed mode: 2.10 MHz (CPU system clock)

#### ◆ Switching the CPU Operating Speed

Immediately after the CGB CPU is reset (immediately after reset cancellation), it operates in normal mode. The CPU mode is switched by executing a STOP instruction with bit 0 of register Key 1 set to a value of 1. If this is done in normal mode, the CPU is switched to double-speed mode; otherwise it is switched to normal mode. Bit 0 of register Key 1 is automatically reset after the operating speed is switched. In addition, bit 7 of register Key 1 serves as the CPU speed flag, indicating the current CPU speed.

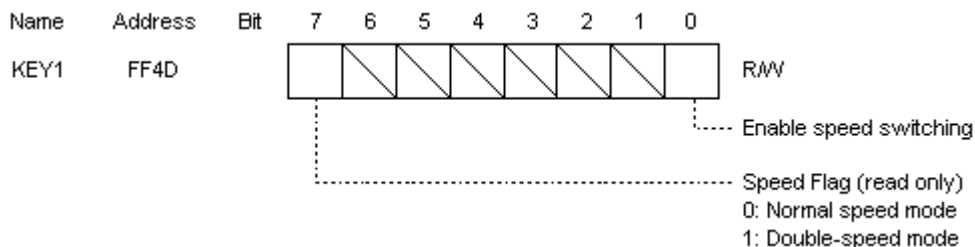

**Note** When bit 0 of register Key 1 is set to 1, the standby function cannot be used. When using the standby function, always confirm that bit 0 of register Key 1 is set to 0. When switching the CPU speed, all interrupt-enable flags should be reset and a STOP instruction executed with bits 4 and 5 of the P1 port register set to 1, as with the standby function (STOP mode). When the CPU speed is switched, a return from STOP mode is automatic, so it is not necessary to generate a STOP mode cancellation. However, until the CPU speed has been changed and the system clock returns, bits 4 and 5 of the P1 port register should be made to hold the value 1.

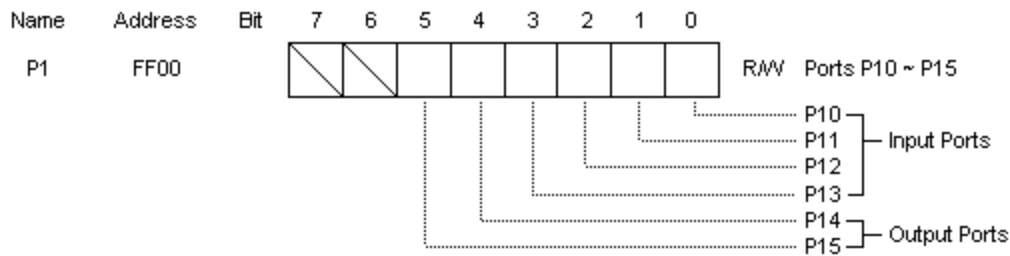

Approximately 16 ms is required to switch from normal to double-speed mode, and approximately 32 ms is needed to switch from double-speed to normal mode. In double-speed mode, the DIV register (0xFF04) and the TIMA register (0xFF05) both operate at double speed. Battery life is shorter in double-speed mode than in normal mode. The use of double-speed mode requires the corresponding mask ROM and MBC.

*Flow of Switching (when switching to double-speed mode)*

In case the CPU operating speed needed to be switched, the current speed should always be checked first using the speed flag (bit 7 of the KEY 1 register). This ensures that the speed will be switched to the intended speed.

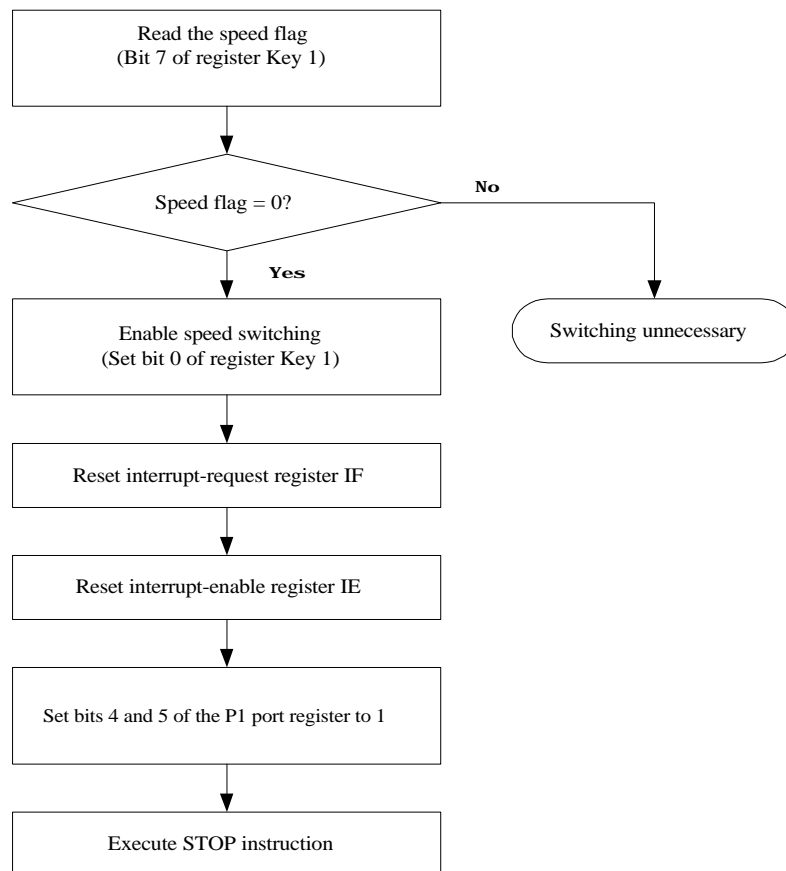

*Switching Routine (example)*

```

LD      HL, KEY1
BIT     7, (HL)
JR      NZ, _NEXT
SET     0, (HL)
XOR     A
LD      (IF), A
LD      (IE), A
LD      A, $30
LD      (P1), A
STOP
    
```

\_NEXT

## 2.6.3 Infrared Communication

### 2.6.3.1 Port Register

The CGB system is equipped with an infrared communication function. An infrared signal can be output by writing data to bit 0 of register RP. A received infrared signal is latched internally in the CPU by positive edge of the system clock. (System clock goes to HIGH from LOW.) The latched data can be read beginning from bit 1 of register RP by setting bits 6 and 7 to 1.

**Note** When data is not sent or received, always set the values of register RP to 0x00. This register cannot be written to in DMG mode.

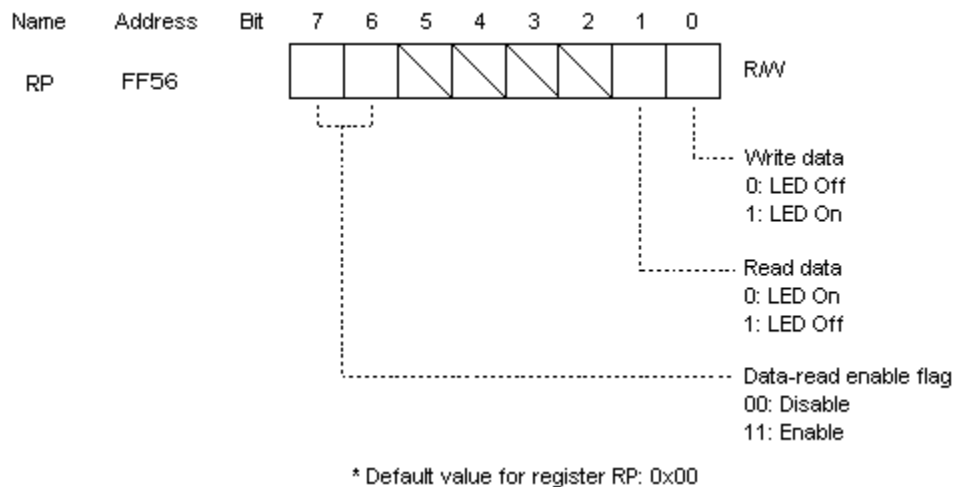

### 2.6.3.2 Controlling Infrared Communication

Sender:

Setting bit 0 of the CPU register RP to 1 causes the LED to emit light; setting it to 0 turns off the LED.

Receiver:

If the photo transistor detects infrared light, bit 1 of register RP is set to 0; if no infrared light is detected, this bit is set to 1.

### 2.6.3.3 Basic Format

When the receiver recognizes the unmodified signal from the sender as a logical value of 1 or 0, the receiver actually cannot distinguish between the continuous transmission of 1s and the absence of received infrared light. The status of the receiver is identical under these conditions. Consequently, to ensure proper data transmission from sender to receiver in Game Boy Color infrared communication, signals are distinguished by the size of the interval between the rising edge of the pulse of one received signal to the rising edge of the subsequent received signal.

The following illustrates signals from a sender.

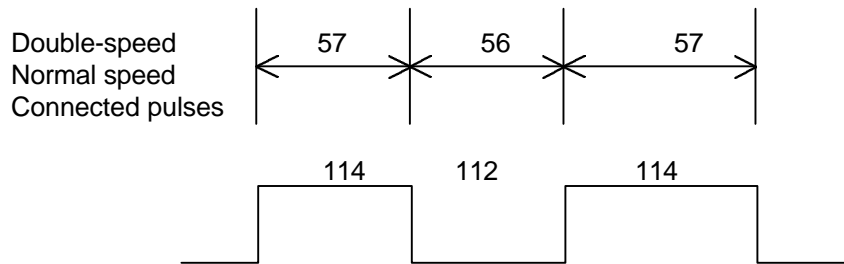
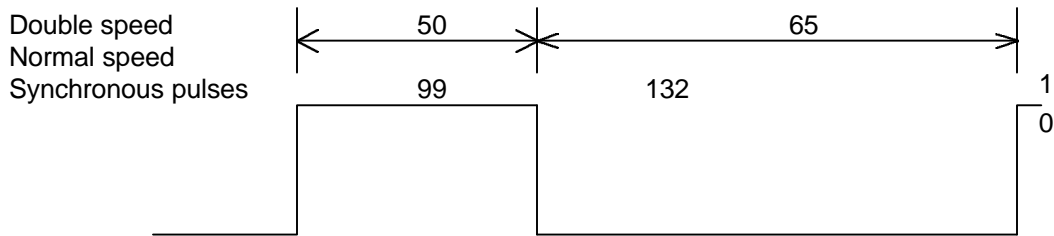
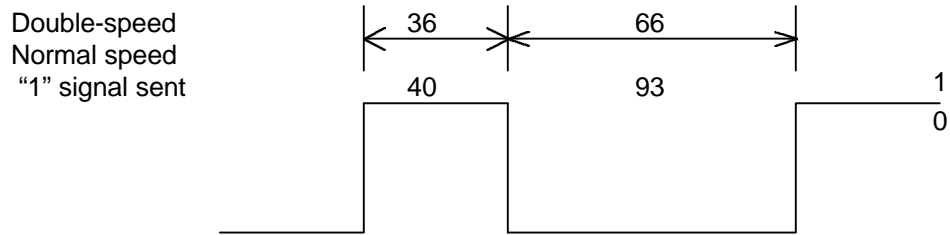
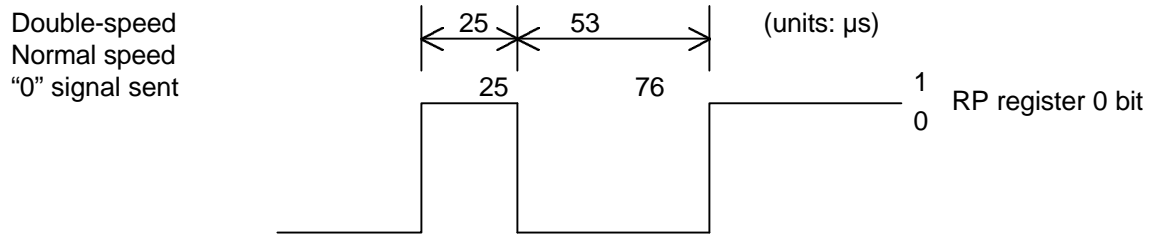

Scatter in the source oscillation of Game Boy Color produces slight individual differences.

#### 2.6.3.4 Preparing for Data Transmission and Reception

To use infrared communication, data reception must be enabled by setting bits 6 and 7 of Game Boy Color register RP to 1. However, even with both of these bits set to 1, data cannot immediately be received. After setting bits 6 and 7 to 1, at least 50 ms should be allowed to pass before using the infrared port.

**2.6.3.5 Transmitted Data**

When data is transmitted and received, it is transmitted in packets. Each packet comprises the 4 parts shown below, and each part is sandwiched between synchronous pulses. For more information, see Section 2.6.3.7, *Details of Data Transmission and Reception*.

The data that comprises a packet is transmitted 1 bit at a time beginning from the MSB.

**Transmission Packet**

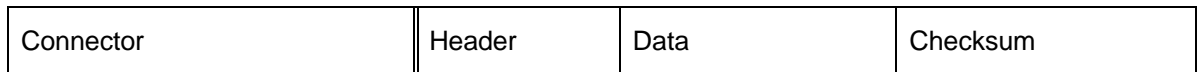

**Connector:**

Signal that implements an infrared communication connection between 2 Game Boy Colors. This is always required in the initial packet. When the receiver receives the connector and recognizes it as a connecting pulse, the receiver returns the same pulse to the sender. The sender then determines whether this signal is a normal connecting pulse. If it is not recognized as a normal pulse, transmission is interrupted at this stage. With continuous communication that is not halted before completion, this part of the packet is unnecessary from the second packet onward.

**Header:**

Data indicating the type of data being sent and the total number of bytes.

Byte 1: Communication command

0x5A: transmission of raw data

At present, any value other than 0x5A causes an error.

(To be used for by other devices in future)

Byte 2: Total number of data in data portion of the packet

0x01-0xFF: Number of data

0x00: Indicates completion of communication to receiver.

**Data:**

The transmitted data itself. Maximum of 255 bytes.

There are no data if completion of communication is indicated to the receiver.

(The data portion of the packet consists only of a synchronous pulse.)

**Checksum:**

2 bytes of data consisting of the sum of the header and all data in the data portion of the packet.

Following this, the communication status is returned from receiver to sender.

**2.6.3.6 Flow of Data Transmission and Reception**

When data is transmitted and received, both Game Boy Colors are first placed in receive status. The one with the send indicator is then designated as the sender, and the other one is designated as the receiver. The flow of data transmission is shown below.

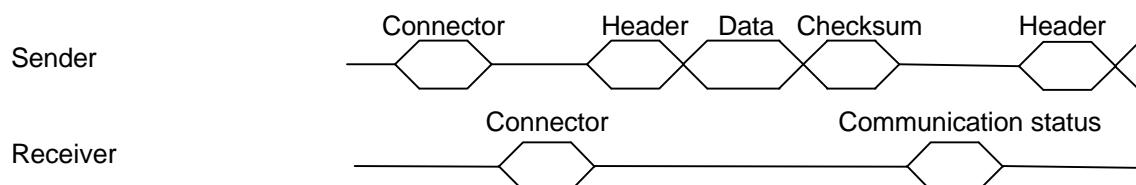

- 1 Sender transmits connecting pulse.
- 2 The receiver calculates the width of the received connecting pulse. If the value is correct, the receiver returns the same connecting pulse to the sender.
- 3 The sender calculates the width of the connecting pulse returned by the receiver. If the value is correct, the sender determines that a connection has been properly established.
- 4 The header is transmitted.
- 5 The data is transmitted.
- 6 The checksum is transmitted.
- 7 The receiver returns the communication status to the sender.
- 8 When communication is complete, the header of the subsequently transmitted packet is set to 0x00 + 0x00.

**2.6.3.7 Details of Data Transmission and Reception**

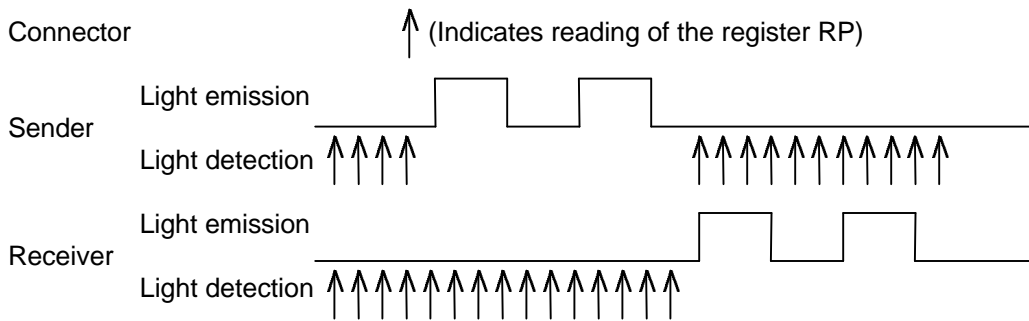

The two Game Boy Colors perform initial data reception, then the one designated as the sender (e.g., by operations such as pressing button A) begins transmission. The connecting portion of the packet is unnecessary from the second packet onward.



The following illustrates the flow for implementing a connection.

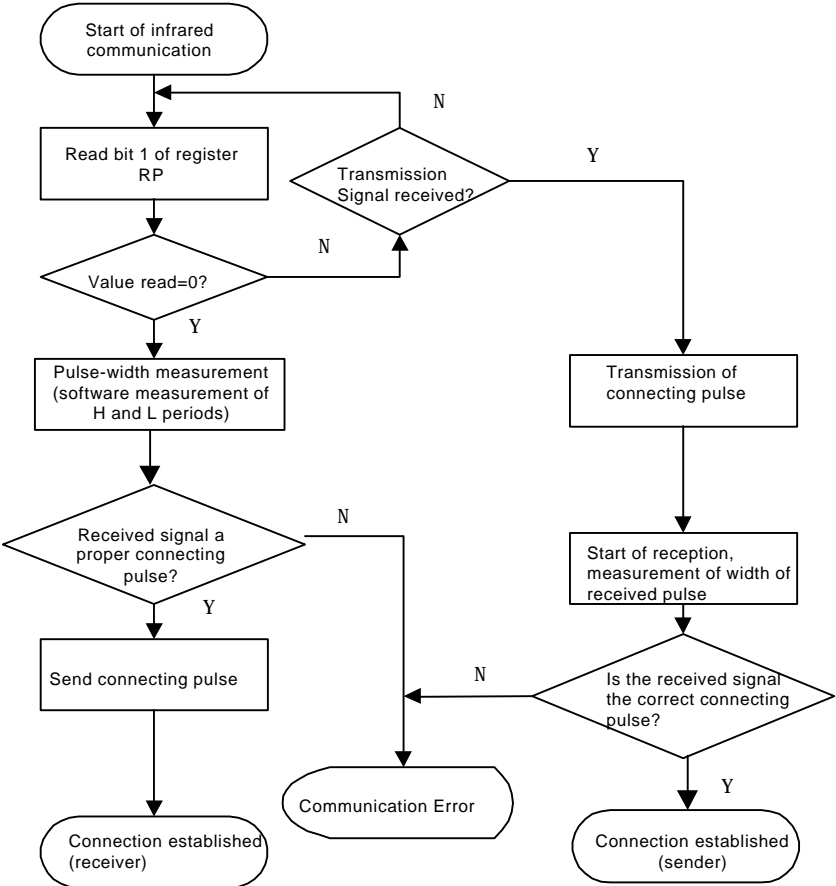

Header

Light emission by sender

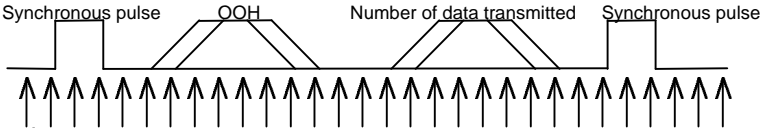

Light detection by receiver

One byte indicating the data type and 1 byte indicating the number of transmitted data are sandwiched between synchronous pulses.

Data

Light emission by sender

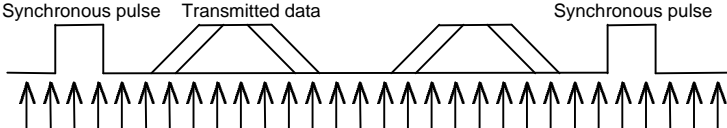

Light detection by receiver

Between 1 and 255 bytes of transmitted data are sandwiched between synchronous pulses.

A 2-byte checksum consisting of the sum of the header and transmitted data is sandwiched between synchronous pulses. The receiver uses the checksum to determine whether the transmission was performed properly and notifies the sender of the results of communication status.

The following section describes the details of communication status determination.

### **2.6.3.8 Communication Status**

0x00: Communication OK  
0x01: Checksum error

The results of the checksum calculated by the receiver do not agree with the checksum sent by the sender.

In the following cases, the communication status cannot be returned to the sender even if an error is generated during communication (no response from receiver).

- ◆ The wrong communication protocol is used.
- ◆ Data is transmitted using the wrong pulse width.
- ◆ One of them is operating in double-speed mode and the other is operating in normal mode.
- ◆ Communication is affected by sunlight or obstruction of the signal light.

### **2.6.3.9 Communication Error Processing**

If an error described above in Communication Status is generated, the following error codes are returned by subroutine.

Error Code	Error Description
01	Checksum error (same for sender and receiver): The results of the checksum calculated by the receiver and the checksum sent by the sender do not agree.
02	Pulse width error: Generated by the receiver when the width of the pulse of the signal sent by the sender is too wide or narrow. Generated by the sender when the width of the pulse of the signal sent by the receiver is too wide or narrow.
04	Communication error: Communication prevented by other causes. The subroutine provided by Nintendo treats as an error the case when the data value of the second byte of the received header exceeds the number of data items to be received, as determined beforehand by the receiver. The routine also generates an error if the communication command value of byte 1 of the header is not 0x5A.

2.6.3.10 Communication Examples

The following figure shows the flow of processing when errors occur during communication. This should be used as a reference when implementing data communication.

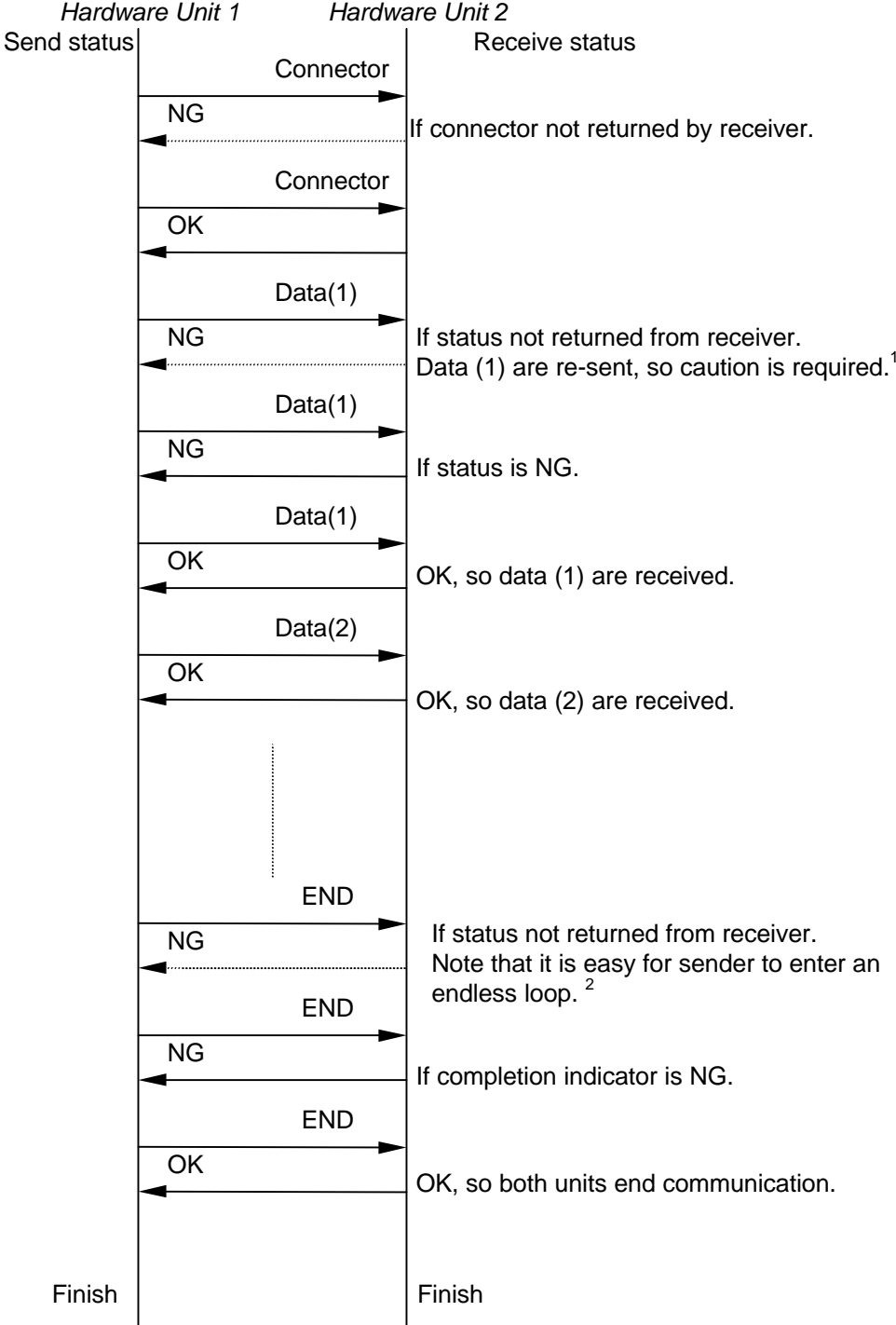

- 1) Data(1) and Data(2) each represent 1 packet for transmission, not including the connector.
- 2) END signifies the packet used to indicate the completion of transmission (not including the connector).

#### **2.6.3.11 Usage Notes**

When programming use of the infrared port, please note the following.

- ◆ When transmitting more than 256 bytes of data, ensure that the receiver keeps track of which packet number is being received. When a communication error (status not returned even though data was received) is generated, the sender will re-send the data, and the receiver may lose track of the packet number (see note 1 of previous section).
- ◆ The sender is prone to entering an endless loop when the packet signifying transmission completion is received. Therefore, the receiver should remain in receive status for approximately 300  $\mu$ s after returning the status (see note 2 of previous section).
- ◆ Depending on the power reserve of the battery, infrared communication may cause a sudden drop in battery voltage and a complete loss of power.
- ◆ Ensure that the speed of the two communicating Game Boy Colors is the same (both double-speed or both normal speed during communication).
- ◆ Noise can be heard from the speaker and headphones during communication, but this does not indicate a problem with the hardware.
- ◆ Ensure that faulty or uncontrolled operation does not occur when infrared communication signals are input from other game software and devices. Use particular care when using the same subroutine to communicate between various types of games, because faulty or uncontrolled operation is especially likely to occur in such cases. (Before performing data communication, confirm that the other hardware participating in the transmission is using the same game. This can be accomplished by means such as exchanging a unique key code.)

The following are items to note when using an infrared communication subroutine other than that provided by Nintendo.

- ◆ Ensure that error-handling is implemented to prevent the program from entering an endless loop when communication is interrupted by sunlight or obstruction of the signal light.
- ◆ To reduce power consumption, use a maximum infrared LED emission pulse duration of 150  $\mu$ s and a duty ratio of approximately 1/2.
- ◆ Do not leave the infrared LED or photo transistor ON when not using infrared communication.

#### **2.6.3.12 Specifications**

- 1) Communication Speed
  - Normal-speed mode: approximately 7.5 Kbps
  - Double-speed mode: approximately 10.5 Kbps
- 2) Communication distances: Minimum, 10 cm, Typical, 15 cm
- 3) Recommended directional angle: approximately  $\pm 15^\circ$

<b>CHAPTER 2: DISPLAY FUNCTIONS .....</b>	<b>46</b>
<b>1. General Display Functions .....</b>	<b>46</b>
1.1 Character Composition.....	46
1.2 LCD Display RAM.....	47
1.3 Character RAM .....	47
1.4 BG Display.....	50
1.5 LCD Screen.....	52
1.6 LCD Display Registers.....	54
1.7 OAM Registers .....	58
1.8 DMA Registers.....	60
1.9 OBJ Display Priority .....	64
<b>2 LCD Color Display (CGB only) .....</b>	<b>65</b>
2.1 Color Palettes .....	65
2.2 Color Palette Composition .....	65
2.3 Writing Data to a Color Palette.....	66
2.4 Overlapping OBJ and BG .....	67
2.5 Display Using Earlier DMG Software (DMG mode).....	67

## CHAPTER 2: DISPLAY FUNCTIONS

### 1. GENERAL DISPLAY FUNCTIONS

#### 1.1 Character Composition

- ◆ The basic character size is an 8 x 8-dot composition.
- ◆ With characters of the basic size:
  - 128 OBJ-only characters are available (256 with CGB)
  - 128 characters can be registered both as OBJ and BG characters (256 with CGB)
  - 128 BG-only characters are available (256 with CGB)
- ◆ On DMG, characters can be represented using 4 shades of gray (including transparent).
- ◆ On CGB, characters can be represented using 32 shades for each color of RGB.
- ◆ The basic character size can be switched to an 8 x 16-dot composition for OBJ characters only. In this case, however, only even-numbered character codes can be specified. Even if an odd-numbered character code is specified, the display will be the same as that seen with an even-numbered code.
- ◆ Up to 40 OBJ characters can be displayed in a single screen, and up to 10 characters can be displayed on each horizontal line. (Stored in OAM (Display RAM: 0xFE00-0xFE9F))
- ◆ The display data for OBJ characters is stored in OAM (Display RAM: 0xFE00~0xFE9F) in the following order:
  - y-axis coordinate
  - x-axis coordinate
  - Character code
  - attribute data
- ◆ Data is written to OAM from working RAM by DMA transfer.
- ◆ OBJ characters are automatically displayed to the screen using the data written to OAM.
- ◆ Data specification ranges for OBJ characters:
  - $0x00 \leq \text{character code} \leq 0xFF$
  - $0x00 \leq X \leq 0xFF$
  - $0x00 \leq Y \leq 0xFF$

## 1.2 LCD Display RAM

The DMG CPU has 8 KB (64 Kbits) of built-in LCD display RAM.  
The CGB CPU has 16 KB (128 Kbits) of built-in LCD display RAM.

In CGB, 16 KB of memory can be joined in the 8 KB (64-Kbit) memory area (0x8000-0x9FFF) by bank switching using the register VBK (0xFF4F). Bank switching is used exclusively in CGB and cannot be used in DMG mode.

### ◆ Mapping of LCD Display RAM

The 16 KB of memory in CGB is partitioned into 2 x 8 KB by register VBK.

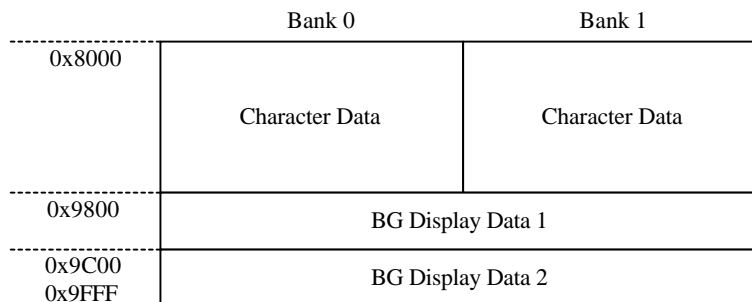

### ◆ Bank Register (CGB) for LCD Display RAM

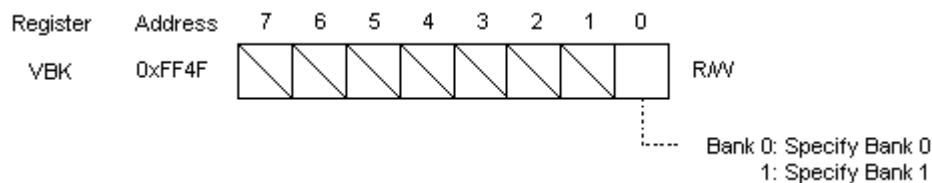

Bank 0 is selected immediately after cancellation of a reset signal.  
This function is available only in CGB. In DMG mode, bit 0 is forcibly set to 0, and its value cannot be changed to 1.

## 1.3 Character RAM

- ◆ Character data can be written to the 6144 bytes from 0x8000 to 0x97FF.
- ◆ By default, the area from 0x8000 to 0x8FFF is allocated for OBJ character data storage.
- ◆ The register LCDC can be used to select either 0x8000-0x8FFF or 0x8800-0x97FF as the area for storing BG and window character data.
- ◆ If the BG character data is allocated to 0x8000-0x8FFF, this data shares an area with OBJ data, and the character dot data that corresponds to the CHR codes is also the same.
- ◆ By means of bank switching, CGB can store twice the amount of character data in LCD display RAM that DMG can store. In this case, both Bank 1 and Bank 0 have the same mapping as the area in DMG.

### Character Code Mapping

With BG character data allocated to 0x8800-0x97FF:

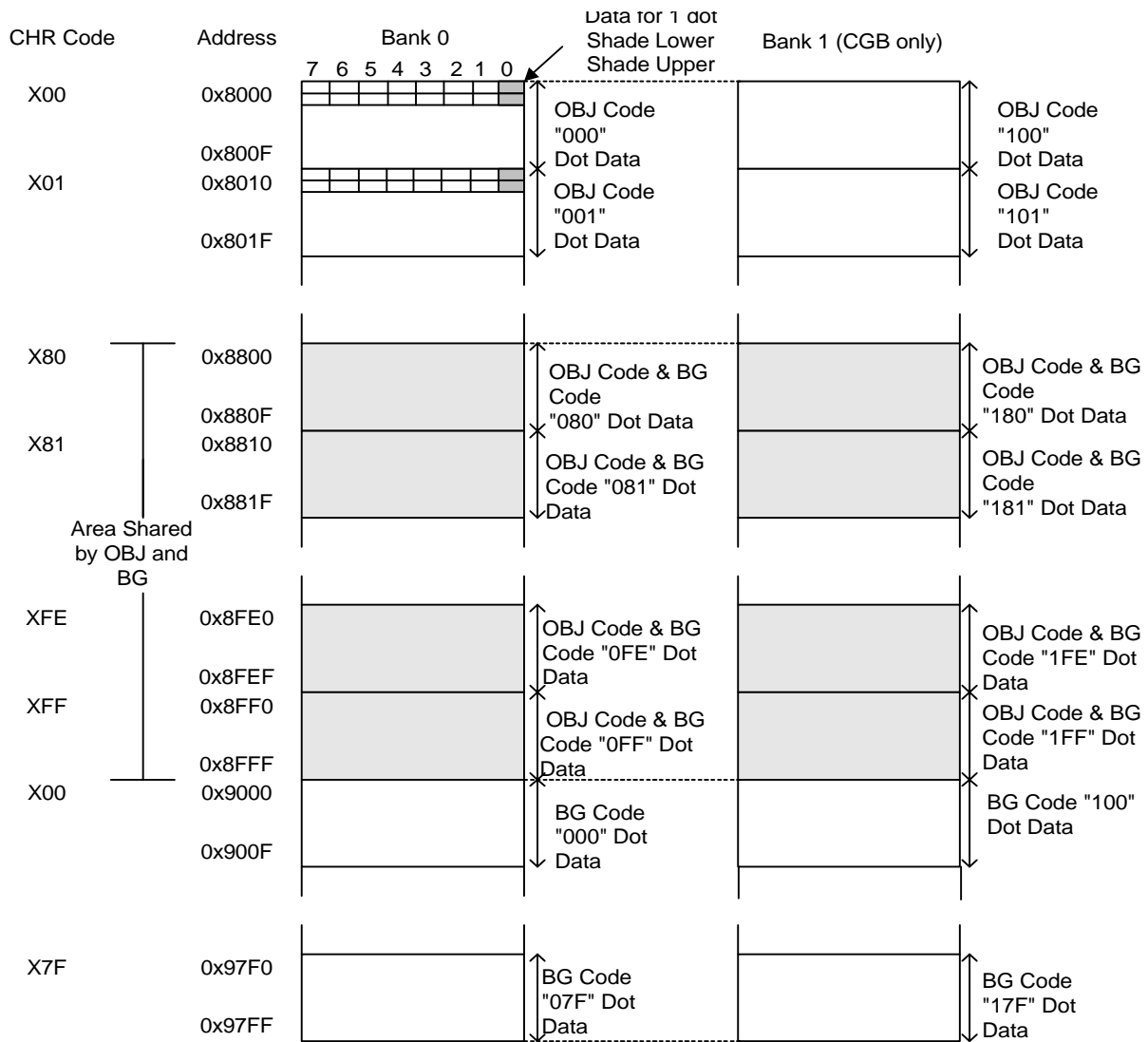

- The case of 8 x 8 dots/block for both BG and OBJ:

CHR Codes:

<DMG>

OBJ: 256 x 1

BG: 256 x 1

<CGB>

OBJ: 256 x 2

BG: 256 x 2

**Note** Because bank switching is not available in DMG mode, Bank 1 on the right side of the figure is not available in this mode.



- ◆ The case of 8 x 16 dots/block (OBJ) and 8 x 8 dots/block (BG):

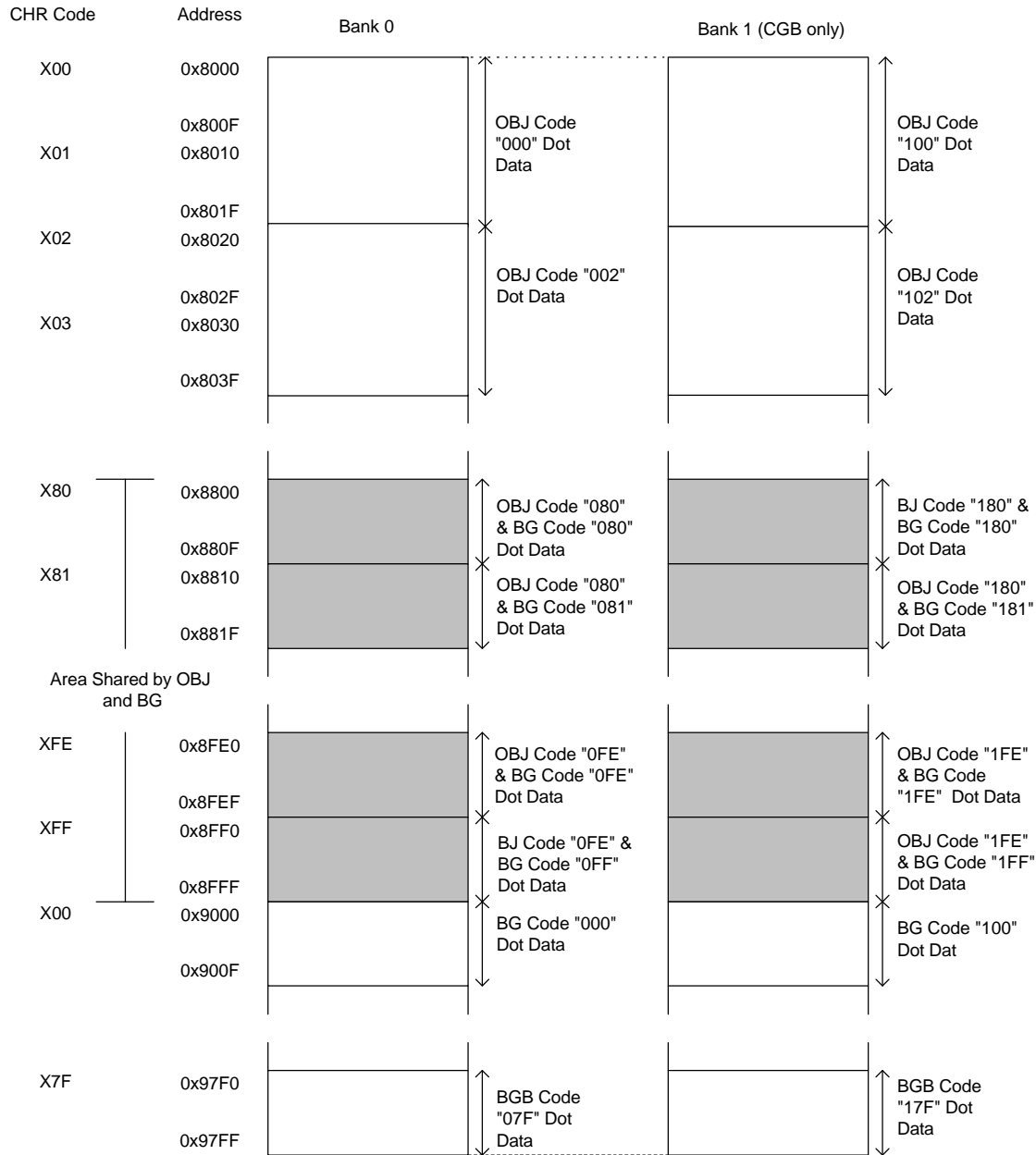

CHR Codes:

<DMG>

OBJ: 128 x 1

BG: 256 x 1

<CGB>

OBJ: 128 x 2

BG: 256 x 2

2) If BG character data is allocated to 0x8000-0x8FFF, these data share an area with OBJ data, and the dot data that correspond to the CHR codes also are the same.

**Note** Because bank switching is not available in DMG mode, Bank 1 on the right side of the figure is not available in this mode.

### 1.4 BG Display

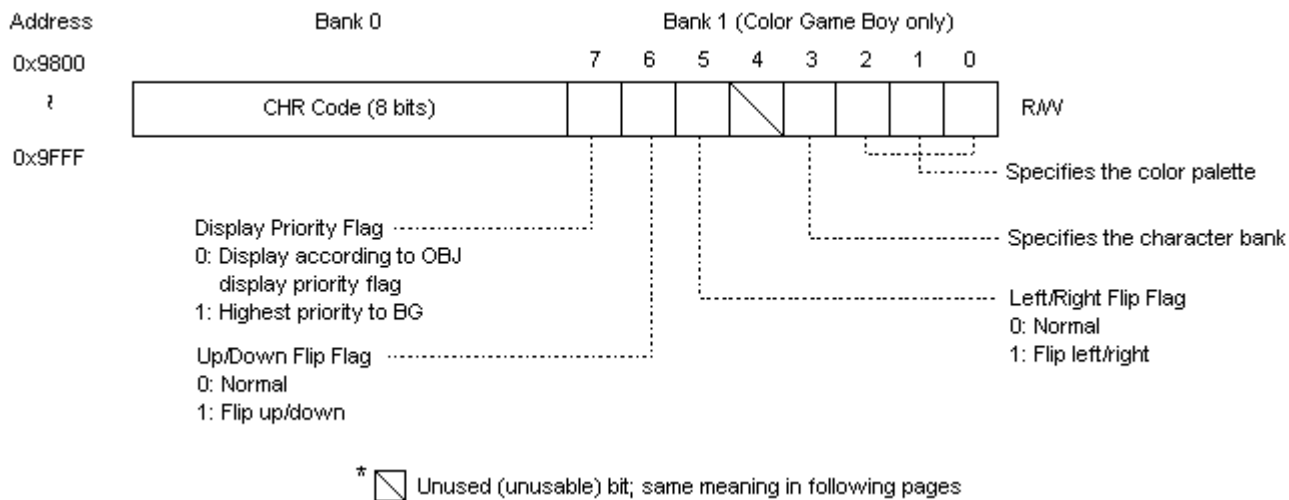

Two screens of BG display can be held, Data 1 or Data 2.

Whether the BG display data is allocated to 0x9800-0x9BFF or to 0x9C00-0x9FFF is determined by bit 3 of the LCDC register (0xFF40).

Because bank switching is not available in DMG mode, Bank 1 on the right side of the figure is not present in this mode.

	Bank 0	Bank 1 (CGB only)
0x9800	BG Display Data 1	
0x9C00	BG Display Data 2	
0x9FFF		

Data for 32 x 32 character codes (256 x 256 dots) can be specified from 0x9800 or 0x9C00 as BG display data. Of these, data for 20 x 18 character codes (160 x 144 dots) are displayed to the LCD screen.

The screen can be scrolled vertically or horizontally one dot at a time by changing the values of scroll registers SCX and SCY.

1) With BG display data allocated to 0x9800-0x9BFF:

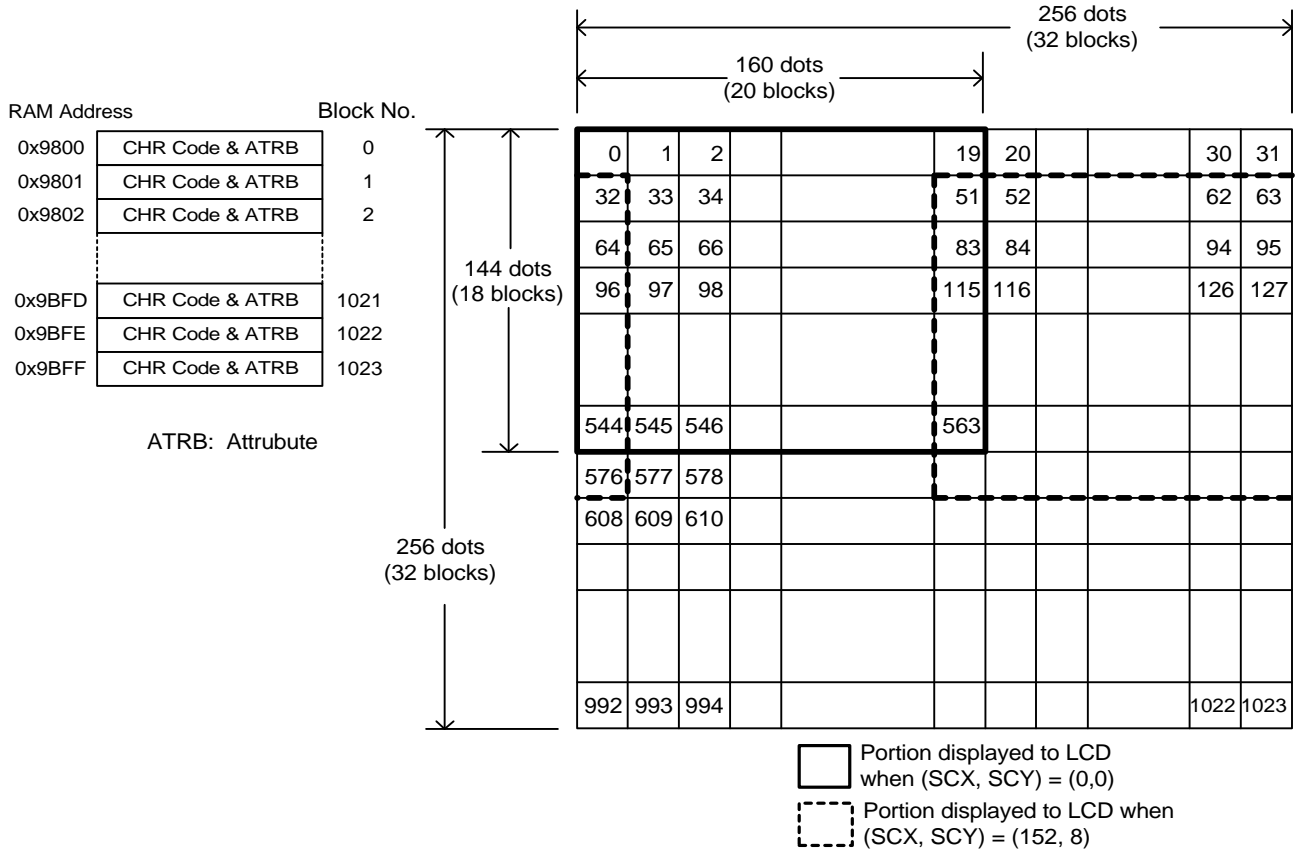

2) With BG display data allocated to 0x9C00-0x9FFF:

RAM Address	Block No.
0x9C00	0
0x9C01	1
0x9C02	2
...	...
0x9FFD	1021
0x9FFE	1022
0x9FFF	1023

Correspondence between LCD screen and block numbers as shown in preceding figure.

ATR: Attribute

Note: Attributes specified only with CGB.

### 1.5 LCD Screen

- ◆ Window Display

Specifying a position on the LCD screen using registers WX and WY causes the window to open downward and to the right beginning from that position.

Window display data also can be specified as character codes, beginning from 0x9800 or 0x9C00 in external SRAM.

OBJ character data is displayed in the window in the same way as the BG screen.

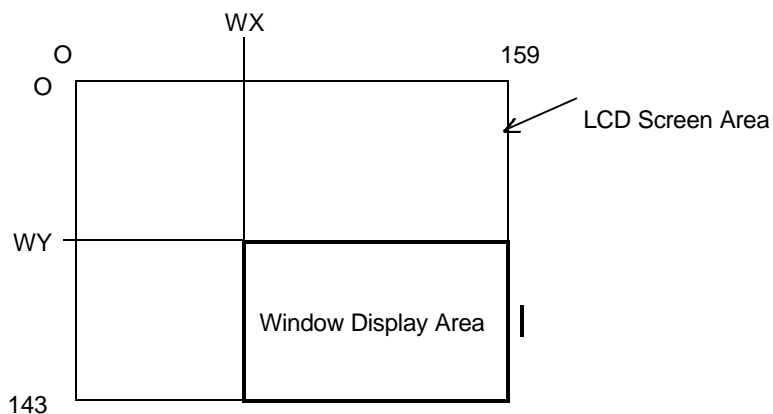

◆ Screen Timing

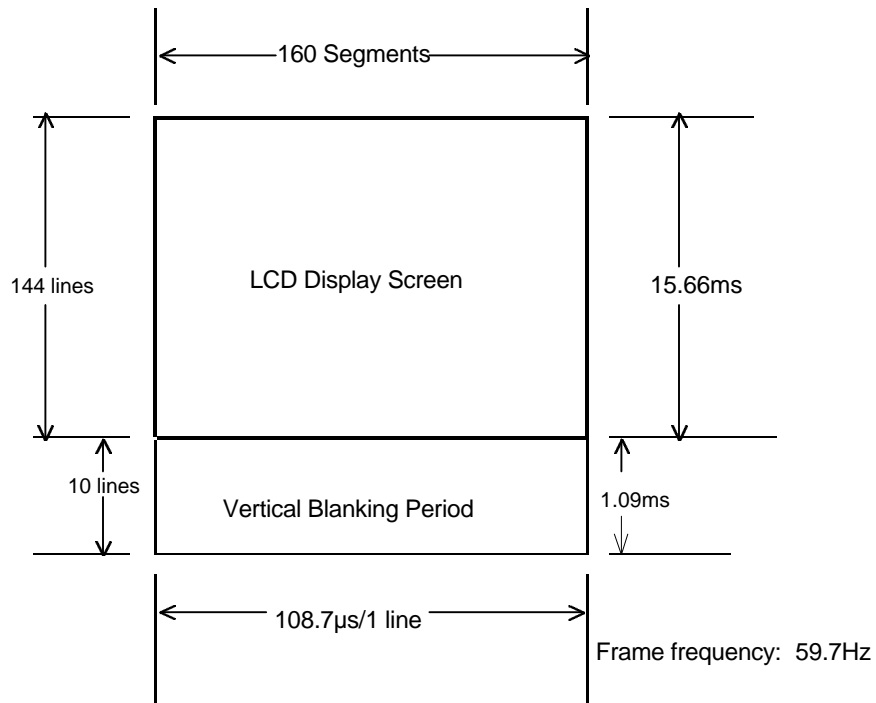

1.6 LCD Display Registers

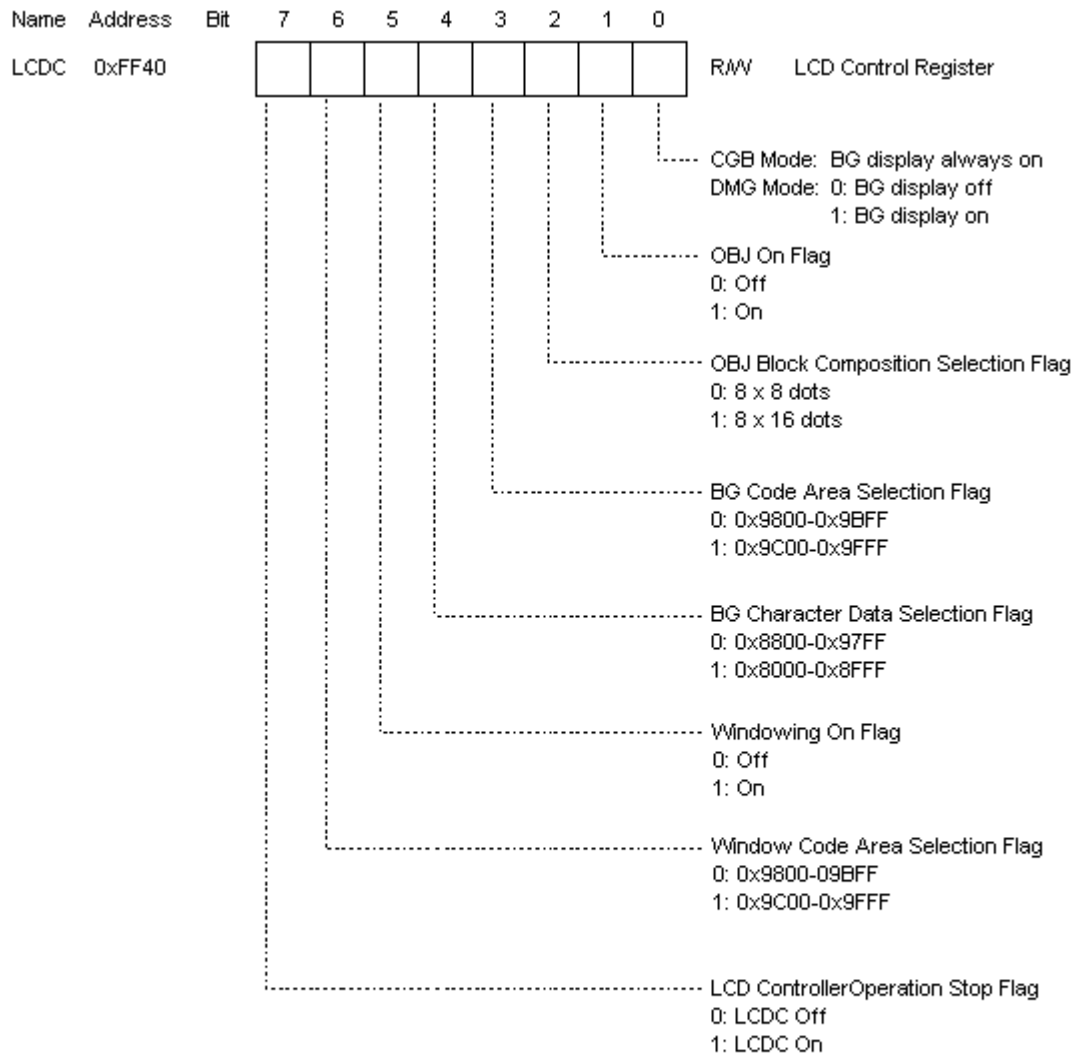

\* In CGB, the liquid crystal protection circuit functions when the LCDC is turned on. Consequently, a white screen is displayed for up to 2 frames. In DMG, the LCDC should be off during vertical blanking periods.

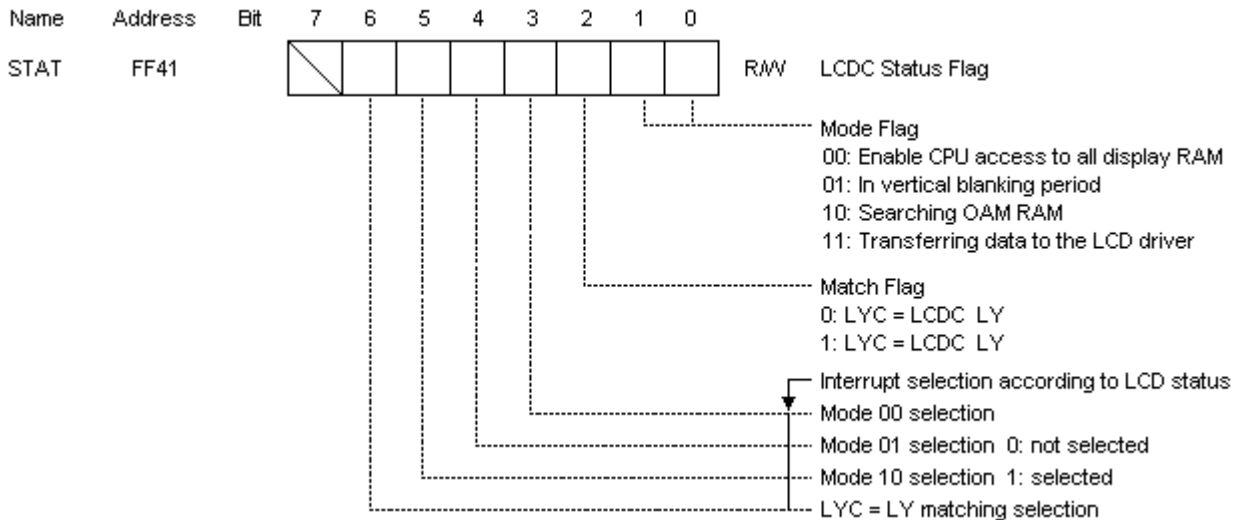

STAT indicates the current status of the LCD controller.

Mode 00: A flag value of 1 represents a horizontal blanking period and means that the CPU has access to display RAM (0x8000-0x9FFF).  
 When the value of the flag is 0, display RAM is in use by the LCD controller.

Mode 01: A flag value of 1 indicates a vertical blanking period and means that the CPU has access (approximately 1 ms) to display RAM (0x8000-0x9FFF).

Mode 10: A flag value of 1 means that OAM (0xFE00-0xFE90) is being used by the LCD controller and is inaccessible by the CPU.

Mode 11: A flag value of 1 means that the LCD controller is using OAM (0xFE00-0xFE90) and display RAM (0x8000-0x9FFF). The CPU cannot access either of these areas.

In addition, the register allows selection of 1 of the 4 types of interrupts from the LCD controller. Executing a write instruction for the match flag resets that flag but does not change the mode flag.

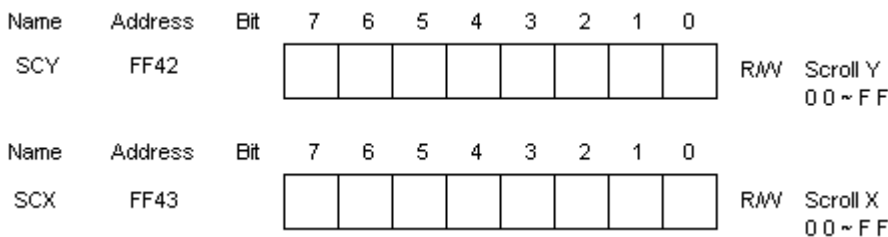

Changing the values of SCY and SCX scrolls the BG screen vertically and horizontally one dot (or pixel) at a time.

**Game Boy Programming Manual**

Name	Address	Bit	7	6	5	4	3	2	1	0	
LY	FF44										R LCDC y-coordinate

LY indicates which line of data is currently being transferred to the LCD driver. LY takes a value of 0-153, with 144-153 representing the vertical blanking period.

When the value of bit 7 of the LCDC register is 1, writing 1 to this again does not change the value of register LY.

Writing a value of 0 to bit 7 of the LCDC register when its value is 1 stops the LCD controller, and the value of register LY immediately becomes 0. (Note: Values should not be written to the register during screen display.)

Name	Address	Bit	7	6	5	4	3	2	1	0	
LYC	FF45										R/W LY Compare

Register LYC is a register compared with register LY. If they match, the Matchflag of the STAT register is set.

**NOTE** *The following 3 registers (BGP, OBP0, and OBP1) are valid in DMG and DMG mode of CGB. For information on CGB color palette settings, see Section 3, LCD Color Display.*



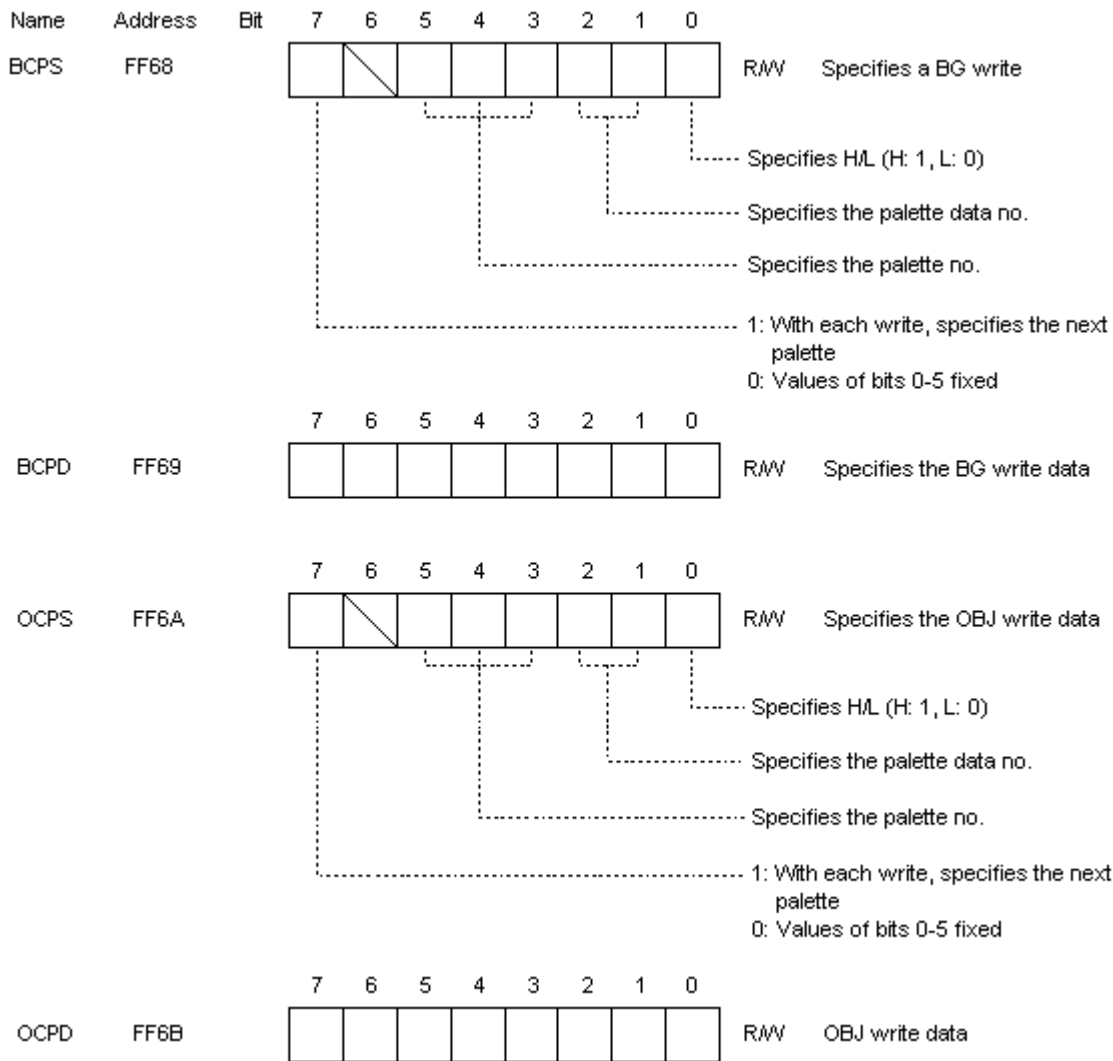

The grayscales (2 bit) for the character dot data is converted by the palette data (BG: register BGP; OBJ: OBP0 or OBP1) and output to the LCD driver as data representing 4 shades (including transparent).

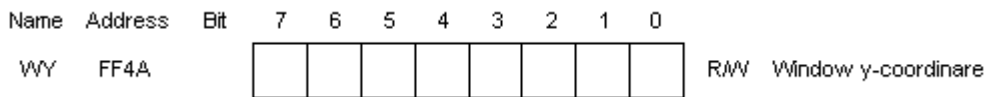

$$0 \leq WY \leq 143$$

With WY = 0, the window is displayed from the top edge of the LCD screen.

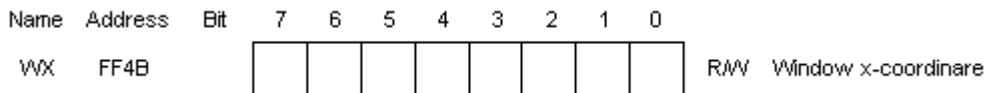

$$7 \leq WX \leq 166$$

With WX = 7, the window is displayed from the left edge of the LCD screen.

Values of 0-6 should not be specified for WX.

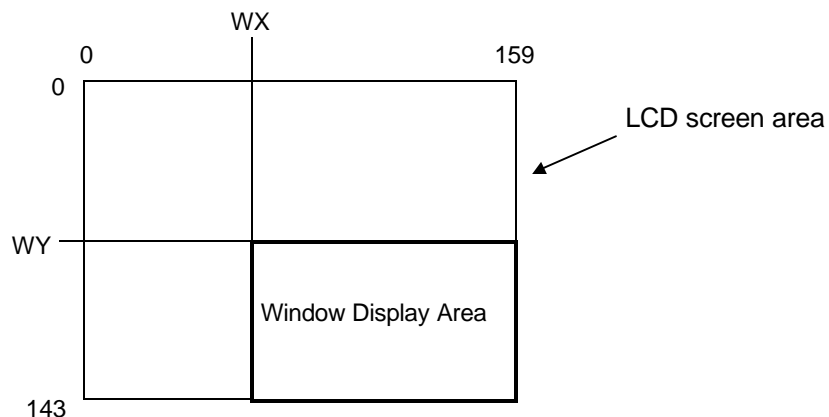

OBJ characters are displayed in the same manner in the window as on BG.

### **1.7 OAM Registers**

OBJ (Object)

- ◆ Data for 40 objects (OBJ) can be loaded into internal OAM RAM in the CPU (0xFE00-0xFE9F), and 40 objects can be displayed to the LCD. Up to 10 objects can be displayed on the same Y line.
- ◆ Each object consists of a y-coordinate (8 bits), x-coordinate (8 bits), and CHR code (8 bits) and specifications for BG and OBJ display priority (1 bit), vertical flip (1bit), horizontal flip (1 bit), DMG-mode palette, (1 bit), character bank (1bit), and color palette (3 bits), for a total of 32 bits.
- ◆ An 8 x 8- or 8 x 16-dot block composition can be specified for an OBJ using bit 2 of the LCDC register. With an 8 x 16-dot composition, the CHR code is specfied as an even number, as in DMG.

**OAM Register**

Name	Address	Bit	7	6	5	4	3	2	1	0	
OBJ0	FE00										R/W LCD y-coordinate 0x00-0xFF With y = 10, object displayed from top edge of LCD screen.
FE01											R/W LCD x-coordinate 0x00-0xFF With x = 8, object displayed from left edge of LCD screen.
FE02											R/W CHR code 0x00-0xFF
FE03											R/W Attribute flag
											<ul style="list-style-type: none"> <li>----- Specifies color palette (CGB only)</li> <li>----- Specifies character bank (CGB only)</li> <li>----- Specifies palette for DMG and DMG mode (valid only in DMG mode)</li> <li>----- Horizontal flip flag 0: Normal 1: Flip horizontally</li> <li>----- Vertical flip flag 0: Normal 1: Flip vertically</li> <li>----- Display priority flag 0: Priority to OBJ 1: Priority to BG</li> </ul>

OBJ1-OBJ39 have the same composition as OBJ0.

**Note** In DMG mode, the lower 4 bits of the attribute flag are invalid; only the flags in the upper 4 bits including the palette flag are valid.

## 1.8 DMA Registers

### 1.8.1 DMA Transfers in DMG

DMA transfers of 40 x 32 bits of data can be performed from the RAM area (0x8000-0xDFFF) to OAM (0xFE00-0xFE9F). The transfer time is 160  $\mu$ s.

Note that in DMG, data cannot be transferred by DMA from ROM area 0x0000-0x7FFF.

The starting address of a DMA transfer can be specified as 0x8000-0xDFFF in increments of 0x100.

Note that the method used for transfers from 0x8000-0x9FFF (display RAM) is different from that used for transfers from other addresses.

#### Example 1

The following example shows how to perform a DMA transfer of 40 x 32 bits from the expansion RAM area (0xC000-0xC09F) to OAM (0xFE00-0xFE9F).

During DMA, the CPU is run using the internal RAM area (0xFF80-0xFFFFE) to prevent external bus conflicts.

1. The program writes the following instructions to internal RAM (0xFF80-0xFFFFE):

Address	Machine Code	Label	Instruction	Comment
FF80	3E C0		LD A, 0C0H	
	E0 46		LD (DMA), A	;C000-C09F→OAM
	3E 28		LD A, 40	;160-cycle wait
	3D	L1:	DEC A	
	20 FD		JR NZ, L1	
	C9		RET	

2. Example of program that writes the above instructions to internal RAM starting from 0xFF80:

	Label	Instruction
		LD C, 80H
		LD B, 10
		LD HL, DMADATA
L2:		LD A, (HL)
		LD (C), A
		INC C
		DEC B
		JR NZ, L2
		•
		•
		•
DMADATA	DB	3EH, 0C0H, 0E0H, 46H, 3EH
	DB	28H, 3DH, 20H, 0FDH, 0C9H

3. When the DMA transfer is performed, the subroutine written to internal RAM shown in Step 1 above is executed:

```

•
CALL    0FF80H    :DMA transfer
•

```

**Note** *The preceding program is used for DMA transfers performed within routines for processing interrupts implemented by vertical blanking. In all other cases, however, the program written to internal RAM should be as shown below to prevent interrupts during a transfer.*

Address	Machine Code	Label	Instruction	Comment
FF80	F3		DI	:Interrupt disabled
	3E C0		LD A, 0C0H	
	E0 46		LD (DMA), A	:C000~C09F→0AM
	3E 28		LD A, 40	:160-cycle wait
	3D	L1:	DEC A	
	20 FD		JR NZ, L1	
	FB		EI	:Interrupt enabled
	C9		RET	

### Example 2

The example below shows a DMA transfer of 40 x 32 bits of data from the display RAM area (0x9F00-0x9F9F) to OAM (0xFE00-0xFE9H).

Machine Code	Label	Instruction	Comment
3E 9F	LD	A, 9FH	
E0 46	LD	(DMA), A	:9F00~9F9F→0AM

Data can be transferred by DMA from 0x8000-0x9F9F to OAM either by the method shown in Example 1 or by using only the above instructions.

### 1.8.2 DMA Transfers in CGB

#### Using the Earlier DMA Transfer Method

This DMA method transfers only 40 x 32 bits of data from 0-0xDFFF to OAM (0xFE00-0xFE9F). The transfer starting address can be specified as 0-0xDFFF in increments of 0x100. The transfer method is the same as that used in DMG, but when data is transferred from 0x8000-0x9FFF (LCD display RAM area), the data transferred are those in the bank specified by bit 0 of register VBK. When transferring data from 0xD000-0xDFFF (unit working RAM area), the data transferred are those in the bank specified by the lower 3 bits of register SVBK.

**Note** *When the CPU is operating at double-speed, the transfer rate is also doubled.*

#### **Using the New DMA Transfer Method**

The DMA transfer method provided for DMG has been augmented in CGB with the following DMA transfer functions.

- 1) Horizontal Blanking DMA Transfer

Sixteen bytes of data can be automatically transferred from the user program area (0-0x7FFF) or external and unit working RAM area (0xA000-0xDFFF) to the LCD display RAM area (0x8000-0x9FFF) during each horizontal blanking period. The number of lines transferred by DMA in a horizontal blanking period can be specified as 1-128 by setting register HDMA5. CPU processing is halted during a DMA transfer period.

2) General-Purpose DMA Transfers

Between 16 and 2048 bytes (specified in 16-byte increments) are transferred from the user program area (0-0x7FFF) or external and unit working RAM area (0xA000-0xDFFF) to the LCD display RAM area (0x8000-0x9FFF). As with horizontal blanking DMA transfers, CPU operation is halted during the DMA transfer period.

The unit working RAM area (0xD000-0xDFFF) selected as the transfer source is the bank specified by register SVBK.

The LCD display RAM area (0x8000-0x9FFF) selected as the transfer destination is the bank specified by register VBK.

**Special Notes**

- ◆ The number of bytes transferred by the new DMA method must be specified in 16-byte increments; byte counts that are not a multiple of 16 cannot be transferred.
- ◆ With the new DMA transfer method, transfers are performed at a fixed rate regardless of whether the CPU is set to operate at normal or double-speed.
- ◆ Horizontal blanking DMA transfer should always be started with the LCDC on and the STAT mode set to a value other than 00.
- ◆ General-purpose DMA transfer should be performed with the LCDC off or during a vertical blanking period.
- ◆ When the new DMA transfer method is used to transfer data from the user program area (0-0x7FFF), mask ROM and MBC for double-speed mode are **required**.

**1.8.3 DMA Control Register: For both DMG and CGB**

Name	Address	Bit	7	6	5	4	3	2	1	0	
DMA	FF46										W DMA transfer and starting address

## 1.8.4 New DMA Control Registers: CGB only

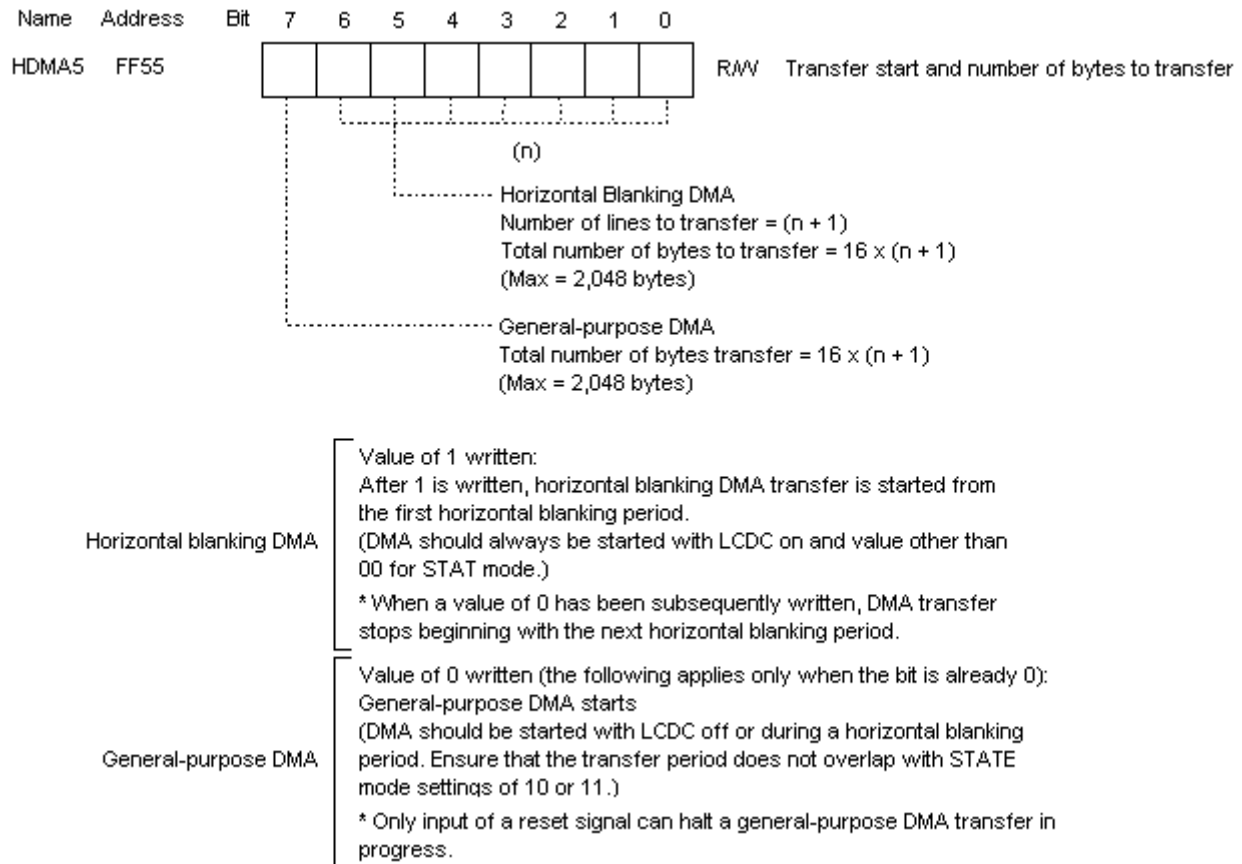

**Note** These registers cannot be written to in DMG mode.

### 1.9 OBJ Display Priority

As a rule, when objects overlap, the one with the lower OBJ number is given priority. In DMG or DMG mode of CGB, among overlapping objects with different x-coordinates, priority is given to the object with the smallest x-coordinate.

1) The case with the same x-coordinate: For both DMG and CGB

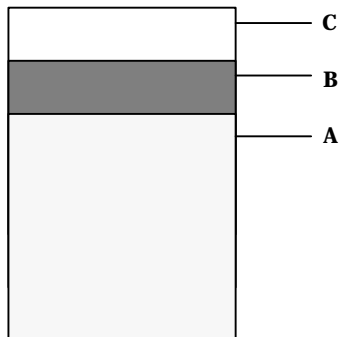

a = No. of OBJ A  
 b = No. of OBJ B  
 c = No. of OBJ C

When  $a < b < c$ , objects are displayed as indicated in the figure at left.

2) The case with different x-coordinates: CGB only

a = No. of OBJ A  
 b = No. of OBJ B  
 c = No. of OBJ C

When  $a < b < c$ , objects are displayed as indicated in the figures below.

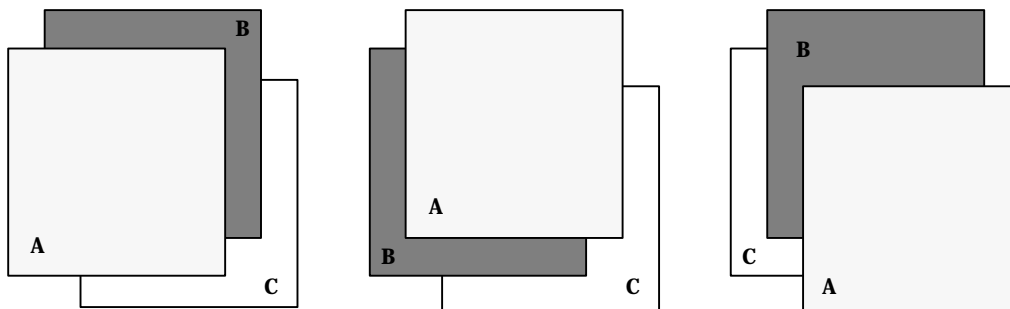

3) Different x-coordinates: DMG/CGB in DMG mode

In DMG mode and with objects with different x-coordinates, the object with the smallest x-coordinate is given priority.

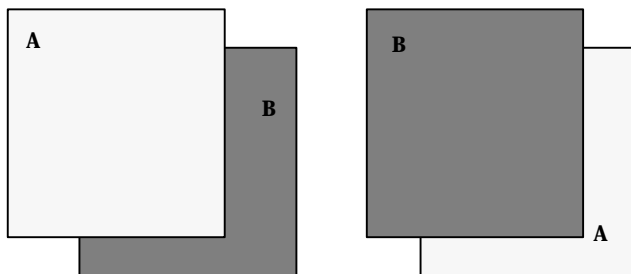

a = No. of OBJ A  
 b = No. of OBJ B

When  $a < b$ , objects are displayed as indicated in the figure at left.



## 2. LCD COLOR DISPLAY (CGB ONLY)

The LCD unit of the CGB system can display 32 shades each for RGB, for a total 32,768 colors. A single color palette consists of 4 colors selected from among these 32,768 colors. One of 8 palettes can be selected for each BG and OBJ character. However, because each OBJ includes transparent data, each OBJ color palette consists of 3 colors. The color palettes for BG and OBJ are independent of one another.

### 2.1 Color Palettes

- ◆ Eight palettes each are provided for BG and OBJ.
- ◆ Each palette consists of 4 colors and is specified by the display dot data (2 bits) (Palette data numbers 0-3).
- ◆ The color palettes represent each color with 2 bytes, with 5 bits of data for each color of RGB (32,768 displayable colors).

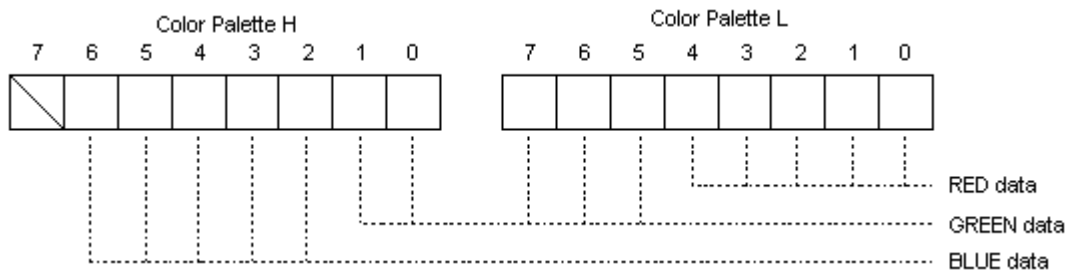

### 2.2 Color Palette Composition

#### 1. BG Color Palettes

Color Palette No.			Palette Data No.
Color palette 0	Color palette H00	Color palette L00	0
	Color palette H01	Color palette L01	1
	Color palette H02	Color palette L02	2
	Color palette H03	Color palette L03	3
Color palettes 1-7			

#### 2. OBJ Color Palettes

OBJ color palettes have the same composition as shown in the figure above.

### 2.3 Writing Data to a Color Palette

Data is written to color palettes using the write-specification and write-data registers. The lower 6 bits of the write-specification register specifies the write address. When data is written to the write-data register, the data will be written to the address specified by the write-specification register. If the highest bit of the write-specification register is set to 1, the write address is then automatically incremented to specify the next address. (The next address is read from the lower 6 bits of the write-specification register.)

The write-specification and write-data registers also are used to read data from color palettes. When the write-data register is read, the data at the address specified by the write-specification register is read. When data is read, the specified address is not incremented even if the most-significant bit of the write-specification register is set to 1.

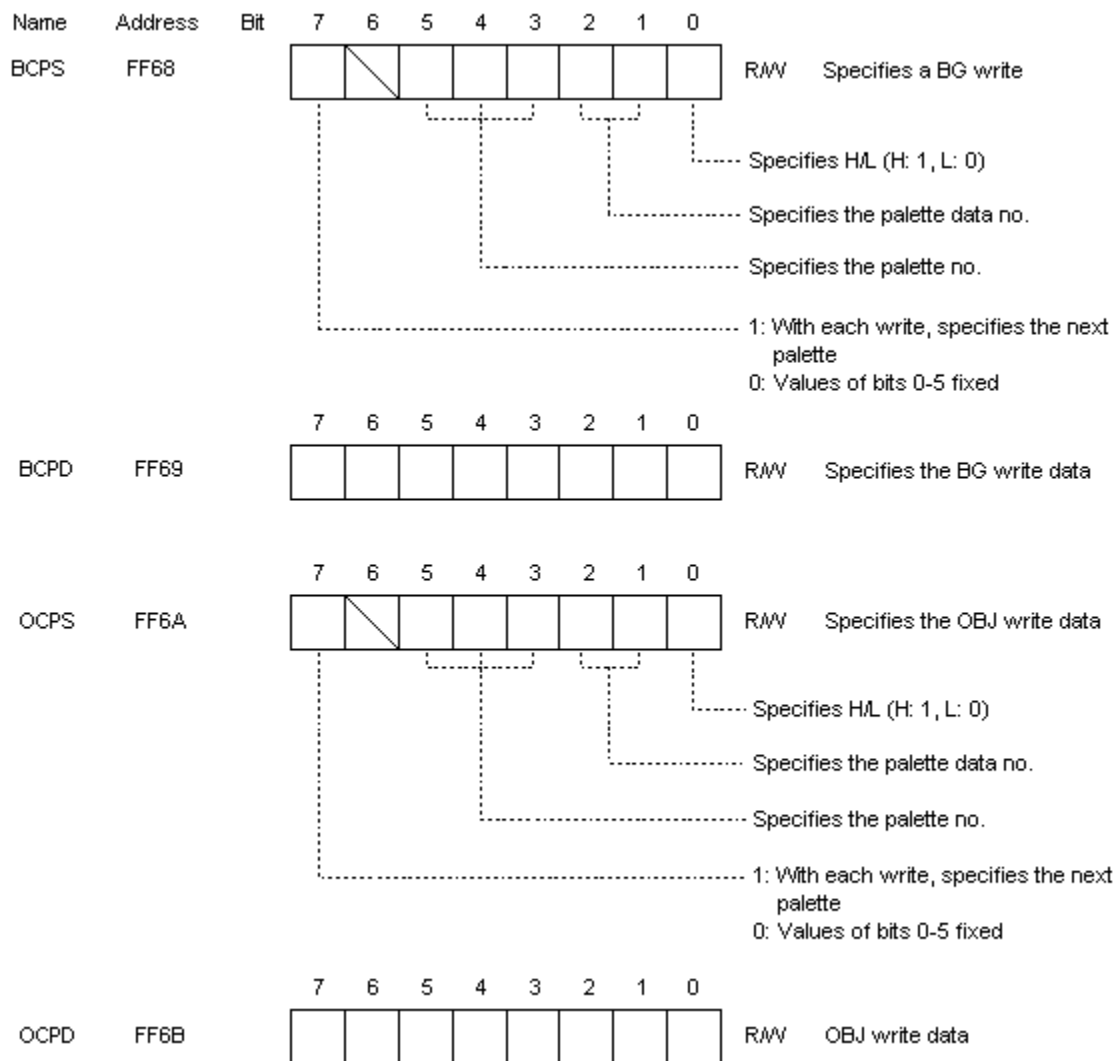

**Note**     *These registers cannot be written to in DMG mode.*

## 2.4 Overlapping OBJ and BG

When objects are displayed, overlapping objects and background are displayed according to the display priority flags for OBJ and BG, as indicated below. The BG display priority flag can be used to assign BG display priority to individual characters.

Display Priority Flag		Dot Data		Screen Display	
BG	OBJ	OBJ	BG	Palette	Data
0: Use OBJ priority	0: Prio- rity to OBJ	00 00 obj obj	00 bg 00 bg	BG BG OBJ OBJ	00 bg obj obj
	1: Prio- rity to BG	00 00 obj obj	00 bg 00 bg	BG BG OBJ BG	00 bg obj bg
1: Highest priority to BG (by character)	0 1	00 00 obj obj	00 bg 00 bg	BG BG OBJ BG	00 bg obj bg

\* obj and bg represent dot data (01, 10, 11) for OBJ and BG, respectively.

## 2.5 Display Using Earlier DMG Software (DMG mode)

When earlier DMG software is used, coloring is performed automatically by the system using registers BGP, OBP0, and OBP1. However, the display uses 3 palettes, 1 for BG, with 4 colors, and 2 for OBJ, each with 3 colors (excluding transparent; maximum of 10 colors in 1 screen).

### 1. BG Display

Colors specified in BG color palette No. 0 are displayed by the dot data (2 bits) whose grayscales are specified by register BGP.

### 2. OBJ Display

Colors specified in OBJ color palettes No. 0 and No. 1 are displayed by the dot data (2 bits) whose grayscales are specified by registers OBP0 and OBP1.

The CGB unit automatically selects the display color according to the color palette pre-registered in the CGB (cannot be changed by a program). However, when turning on power to the CGB, the player can select from a combination of the 12 colors registered in the unit. This function is available only in DMB mode.

***THIS PAGE WAS INTENTIONALLY LEFT BLANK.***

<b>Chapter 3: Sound Functions .....</b>	<b>70</b>
<b>1. Overview of Sound Functions.....</b>	<b>70</b>
<b>2. Sound Control Registers .....</b>	<b>72</b>
<b>2.1 Sound 1 Mode Registers .....</b>	<b>72</b>
<b>2.2 Sound 2 Mode Registers .....</b>	<b>75</b>
<b>2.3 Sound 3 Mode Registers .....</b>	<b>76</b>
<b>2.4 Sound 4 Mode Registers .....</b>	<b>78</b>
<b>2.5 Sound Control Registers.....</b>	<b>80</b>
<b>3. VIN Terminal Usage Notes.....</b>	<b>81</b>

## CHAPTER 3: SOUND FUNCTIONS

### 1. OVERVIEW OF SOUND FUNCTIONS

The sound circuitry consists of circuits that generate 4 types of sounds (Sounds 1-4). It can also synthesize external audio input waveforms and output sounds. (External audio input is a function available only in CGB).

Sound 1: Generates a rectangle waveform with sweep and envelope functions.

Sound 2: Generates a rectangle waveform with an envelope function.

Sound 3: Outputs any waveform from waveform RAM.

Sound 4: Generates white noise with an envelope function.

Each sound has two modes, ON and OFF.

- ◆ ON Mode

Sounds are output according to data in the mode register for each sound.

The mode register data can be specified as needed while outputting sound.

- ◆ Initialization Flag

When the default envelope values are set and the length counter is restarted, the initialization flag is set to 1 and the data is initialized.

- ◆ Mute

In the following instances, the synthesizer will enter mute status. No sound will be output regardless of the ON flag setting.

Sounds 1, 2, and 4:

- When the output level is 0 with the default envelope value set to a value other than 0000 and in DOWN mode

- When the step is 0 with the default envelope value set to a value of 0000 and in UP mode (NR12, NR22, and NR42 set to 0x08 and the initialization flag set)

Sound 3:

With the output level set to mute  
(bits 5 and 6 of NR32 set to 0)

- ◆ Stop Status

In the following cases, the ON flag is reset and sound output is halted.

- Sound output is halted by the length counter.

- With Sound 1, during a sweep operation, an overflow occurs in addition mode.

- ◆ OFF Mode

Stops operation of the frequency counter and D/A converter and halts sound output.

- ◆ Sounds 1, 2, and 4:

- When the default level is set to 0000 with the envelope in DOWN mode (initialization not required)

- ◆ Sound 3:

- When the Sound OFF flag (bit 7 of NR30) is set to 0.  
Setting the Sound OFF flag to 1 cancels OFF mode.

Sound 3 is started by re-initialization.

- ◆ All Sounds OFF mode
  - Setting the All Sounds ON/OFF flag (bit 7 of NR52) to 0 resets all of the mode registers (for sounds 1, 2, 3, and 4) and halts sound output. Setting the All Sounds ON/OFF flag to 1 cancels All Sounds OFF mode.

<b>Note</b> <b><i>The sound mode registers should always be set after All Sound OFF mode is canceled. The sound mode registers cannot be set in All Sound OFF mode.</i></b>
---

- ◆ Sound Usage Notes
  - Use one of the following methods to halt sounds 1, 2, or 4.
    - 1) Use NR51.
    - 2) Set NR12, NR22, and NR42 to 0x08.
    - 3) Set NR14, NR24, and NR44 to 0x80.

## 2. SOUND CONTROL REGISTERS

### 2.1 Sound 1 Mode Registers

Sound 1 is a circuit that generates a rectangle waveform with sweep and envelope functions. It is set by registers NR10, NR11, NR12, NR13, and NR14.

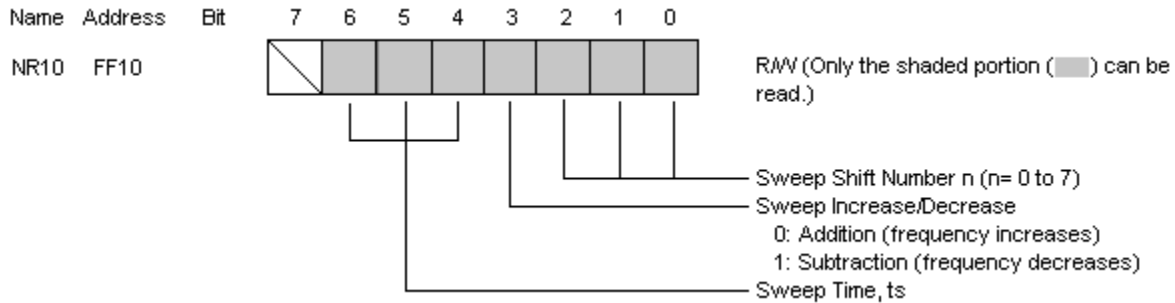

◆ Sweep Shift Number

The frequency with one shift (NR13 and NR14) is determined by the following formula.

$$X(t) = X(t-1) \pm X(t-1) / 2^n \quad n = 0 \text{ to } 7$$

X(0) = default data

X(t-1) is the previous output frequency

If the result of this formula is a value consisting of more than 11 bits, sound output is stopped and the Sound 1 ON flag of NR52 (bit 0) is reset.

In a subtraction operation, if the subtrahend is less than 0, the result is the pre-calculation value X(t) = X(t-1). However, if n = 0, shifting does not occur and the frequency is unchanged.

◆ Sweep time (ts)

Frequency varies with each value of ts.

000: Sweep OFF

001: ts=1/f128 (7.8ms)

010: ts=2/f128 (15.6ms)

011: ts=3/f128 (23.4ms)

100: ts=4/f128 (31.3ms)

101: ts=5/f128 (39.1ms)

110: ts=6/f128 (46.9ms)

111: ts=7/f128 (54.7ms)

f128=128Hz

Example: When NR10 = 0x79 and the default frequency = 0x400, the sweep waveform appears as follows.

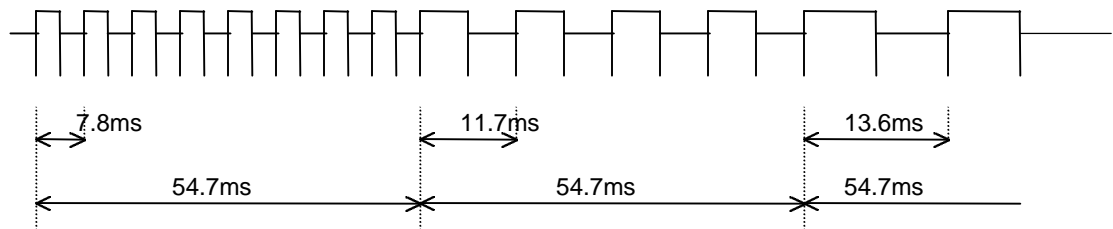

**Note** When the sweep function is not used, the increase/decrease flag should be set to 1 (subtraction mode).



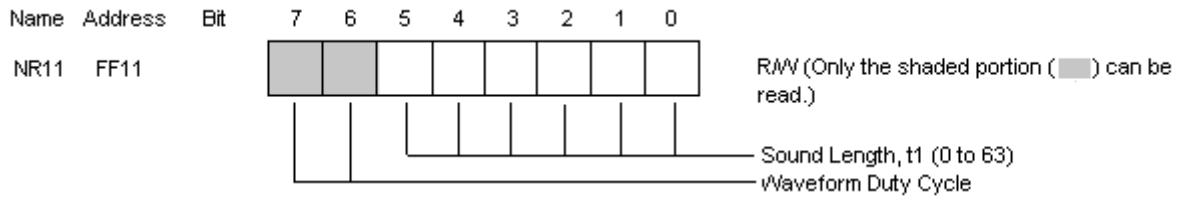

Sound length =  $(64 - t1) \times (1/256)$  sec

Waveform Duty Cycles

00 : 12.5%

01 : 25%

10 : 50%

11 : 75%

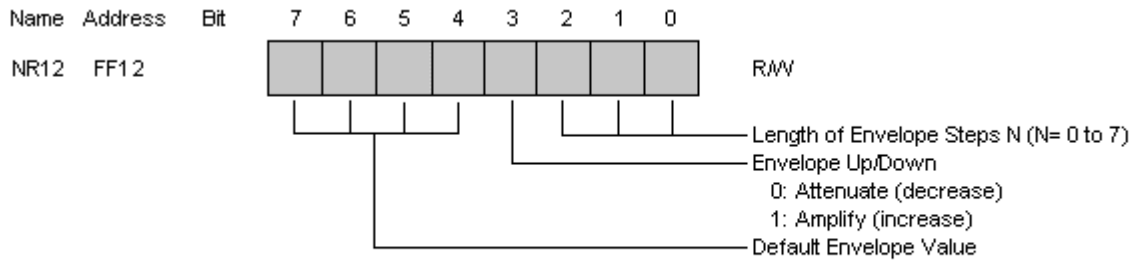
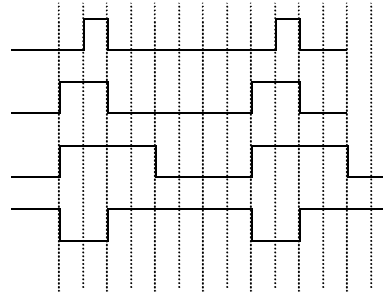

Length of Envelope Steps:

Sets the length of each step of envelope amplification or attenuation.

Length of 1 step =  $N \times (1/64)$  sec

When  $N = 0$ , the envelope function is stopped.

Default Envelope Value (0000 to 1111<sub>B</sub>):

16 step levels can be specified using the 4-bit D/A circuit.

Maximum is 1111<sub>B</sub>, and 0000 is the mute setting.

Example: When NR12 = 0x94, the Amp Gain is as follows.

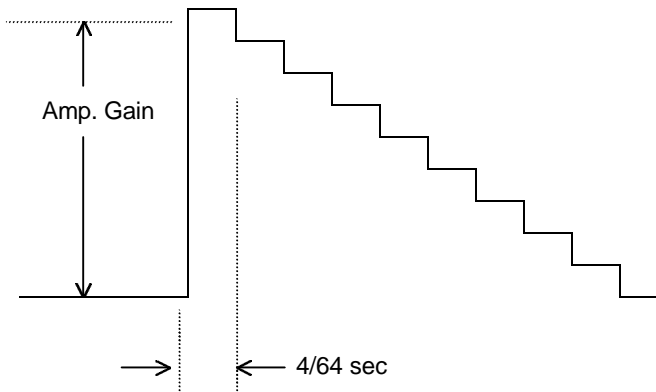

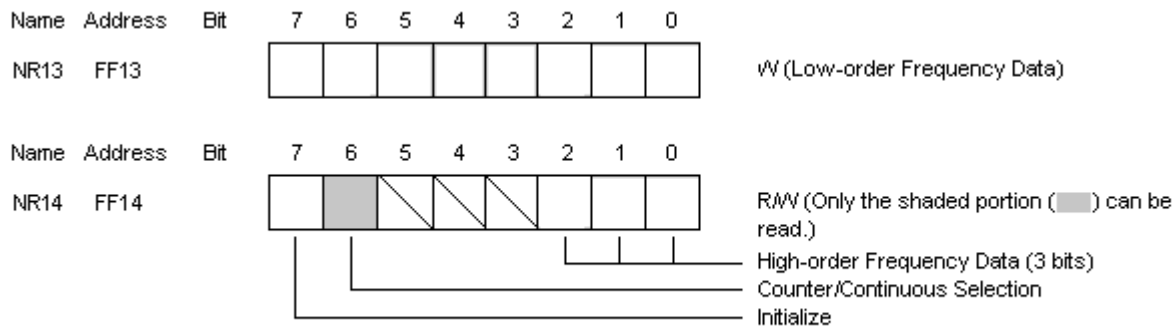

Counter/Continuous Selection

- 0: Outputs continuous sound regardless of length data in register NR11.
  - 1: Outputs sound for the duration specified by the length data in register NR11.
- When sound output is finished, bit 0 of register NR52, the Sound 1 ON flag, is reset.

Initialize

Setting this bit to 1 restarts Sound 1.

With the 11-bit frequency data specified in NR13 and NR14 represented by x, the frequency, f, is determined by the following formula.

$$f = 4194304 / (4 \times 2^x \times (2048 - X)) \text{ Hz}$$

Thus, the minimum frequency is 64 Hz and the maximum is 131.1 KHz.

◆ Sound 1 Usage Notes

When no sweep function is used with Sound 1, the sweep time should be set to 0 (sweep OFF). In addition, either the sweep increase/decrease flag should be set to 1 or the sweep shift number set to 0 (set to 0x08-0x0F or 0x00 in NR10).

Sound may not be produced if the sweep increase/decrease flag of NR10 is set to 0 (addition mode), the sweep shift number set to a value other than 0, and the mode set to sweep OFF (e.g. NR10 = 0x01)

If the contents of the envelope register (NR12) needs to be changed during sound operation (ON flag set to 1), the initialize flag should be set after the value in the envelope register is set.

## 2.2 Sound 2 Mode Registers

Sound 2 is a circuit that generates a rectangle waveform with an envelope function. It is set by registers NR21, NR22, NR23, and NR24.

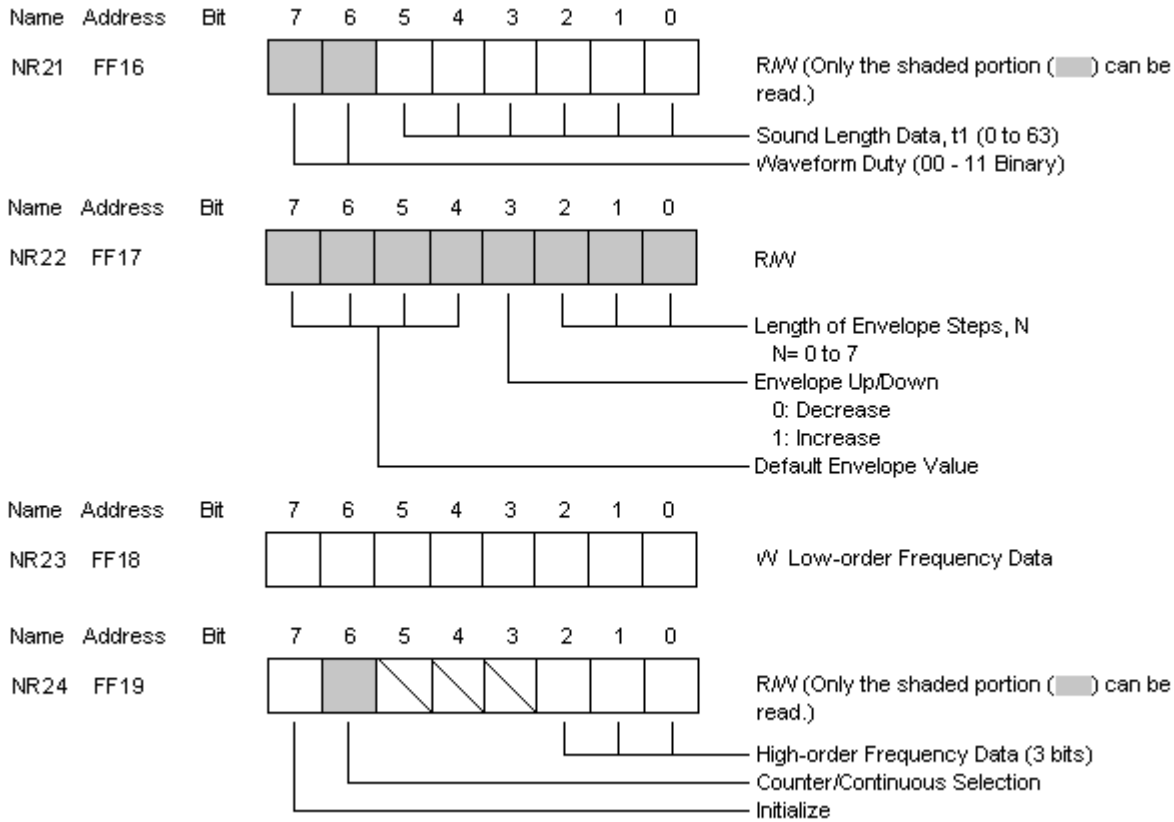

### Counter/Continuous Selection

0: Outputs continuous sound regardless of length data in register NR21.

1: Outputs sound for the duration specified by the length data in register NR21.

When sound output is finished, bit 1 of register NR52, the Sound 2 ON flag, is reset.

### Initialize

Setting this bit to 1 restarts Sound 2.

### ◆ Sound 2 Usage Notes

If the contents of the envelope register (NR22) needs to be changed during sound operation (ON flag set to 1), the initialize flag should be set after the value in the envelope register is set.

### 2.3 Sound 3 Mode Registers

Sound 3 is a circuit that generates user-defined waveforms. It automatically reads a waveform pattern (1 cycle) written to waveform RAM at 0xFF30-0xFF3F, and it can output a sound while changing its length, frequency, and level by registers NR30, NR31, NR32, NR33, and NR34.

The settings of the sound length and frequency functions and data are the same as for the Sound 1 circuit.

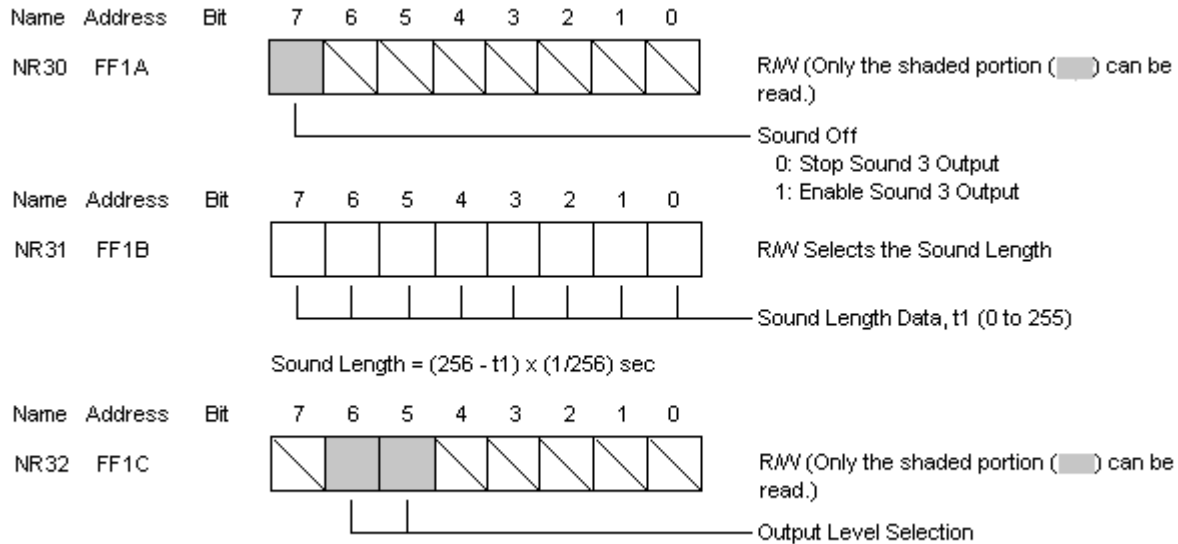

**Output Level:**

- 00: Mute
- 01: Output waveform RAM data (4-bit length) unmodified.
- 10: Output waveform RAM data (4-bit length) shifted 1 bit to the right (1/2).
- 11: Output waveform RAM data (4-bit length) shifted 2 bits to the right (1/4).

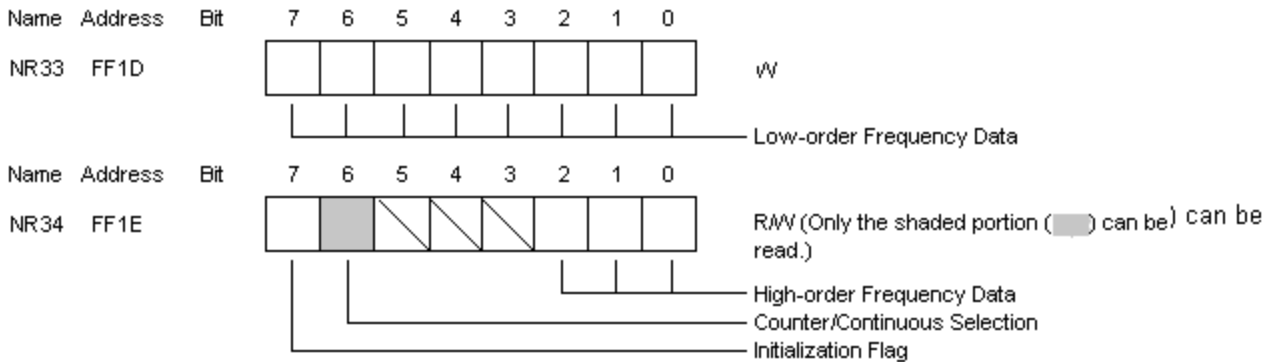

**Counter/Continuous Selection**

- 0: Outputs continuous sound regardless of length data in register NR31.
  - 1: Outputs sound for the duration specified by the length data in register NR31.
- When sound output is finished, bit 2 of register NR52, the Sound 3 ON flag, is reset.

Initialization Flag

When the Sound OFF flag (bit 7, NR30) is set to 1, setting this bit to 1 restarts Sound 3.

◆ Sound 3 Usage Notes

- The initialization flag should not be set when the frequency is changed during Sound 3 output.
- Setting the initialization flag during Sound 3 operation (Sound 3 ON flag = 1) may destroy the contents of waveform RAM.
- Setting the initialization flags for Sound 1, Sound 2, or Sound 4 does not cause a problem.

◆ Waveform RAM Composition

Waveform RAM consists of waveform patterns of 4 bits x 32 steps.

Address	D7	D6	D5	D4	D3	D2	D1	D0
FF30		Step 0				Step 1		
FF31		Step 2				Step 3		
FF32		Step 4				Step 5		
⋮								
FF3F		Step 30				Step 31		

Example: Triangular Wave

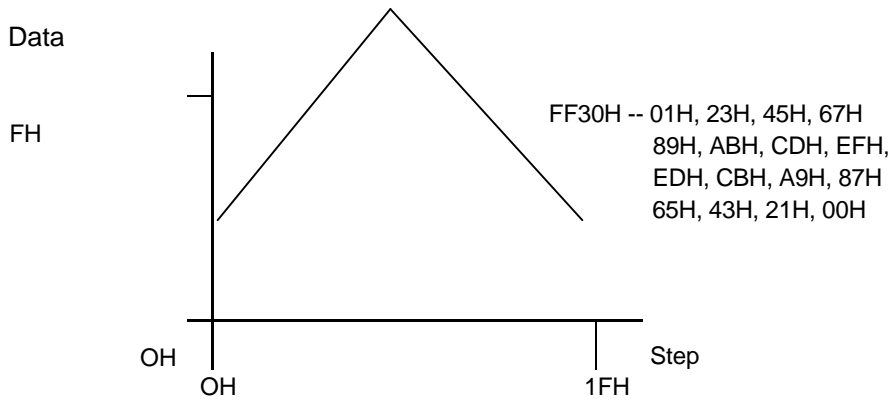

## 2.4 Sound 4 Mode Registers

Sound 4 is a white-noise generating circuit. It can output sound while switching the number of steps of the polynomial counter for random number generation and changing the frequency dividing ratio and envelope data by registers NR41, NR42, NR43, and NR44.

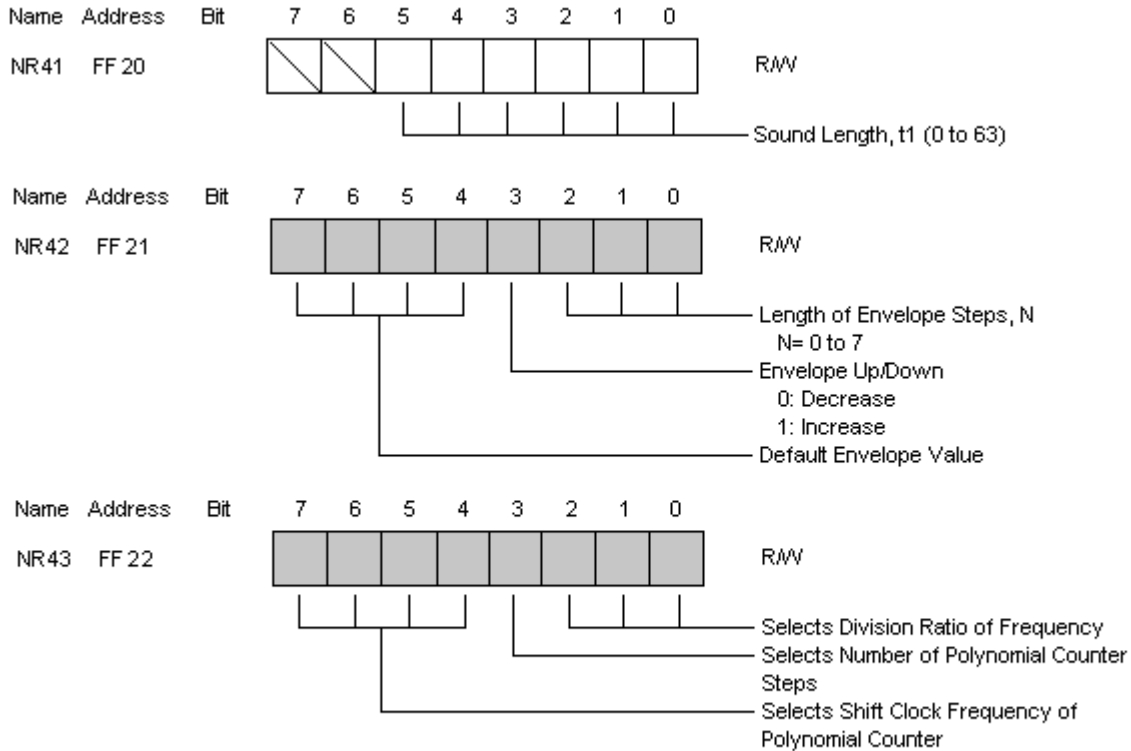

Selecting the dividing ratio of the frequency:

Selects a 14-step prescaler input clock to produce the shift clock for the polynomial counter.

000 :  $fx/2^3 \times 2$

001 :  $fx/2^3 \times 1$

010 :  $fx/2^3 \times 1/2$

011 :  $fx/2^3 \times 1/3$

100 :  $fx/2^3 \times 1/4$

101 :  $fx/2^3 \times 1/5$

110 :  $fx/2^3 \times 1/6$

111 :  $fx/2^3 \times 1/7$

$f=4/19430\text{MHz}$

Selecting the number of steps for the polynomial counter:

0: 15 steps

1: 7 steps

Selecting the shift clock frequency of the polynomial counter:

- 0000: Dividing ratio frequency x 1/2
- 0001: Dividing ratio frequency x 1/2<sup>2</sup>
- 0010: Dividing ratio frequency x 1/2<sup>3</sup>
- 0011: Dividing ratio frequency x 1/2<sup>4</sup>
- ⋮
- 1101: Dividing ratio frequency x 1/2<sup>14</sup>
- 1110: Prohibited code
- 1111: Prohibited code

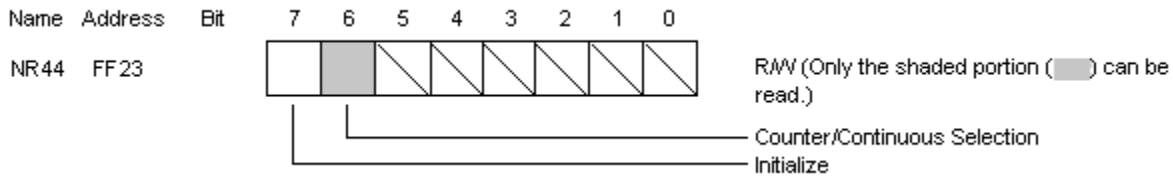

Counter/Continuous Selection:

- 0: Outputs continuous sound regardless of length data in register NR41.
- 1: Outputs sound for the duration specified by the length data in register NR41.  
When sound output is finished, bit 3 of register NR52, the Sound 4 ON flag, is reset.

Initialize:

Setting this bit to 1 restarts Sound 4.

- Sound 4 Usage Notes

If the contents of the envelope register (NR22) needs to be changed during sound operation (ON flag set to 1), the initialize flag should be set after the value in the envelope register is set.

### 2.5 Sound Control Registers

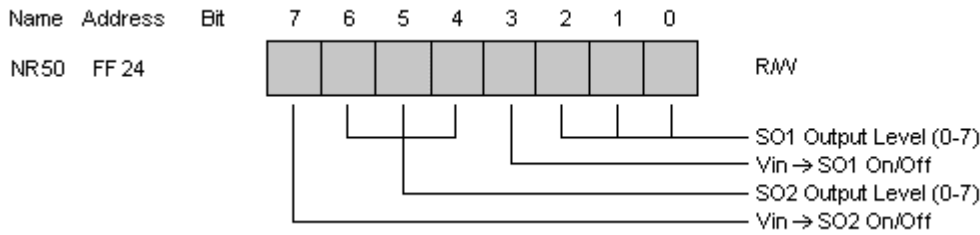

Output Level:  
 000: Minimum level (Maximum level ÷ 8)  
 111: Maximum level

Vin → S01 ON/OFF (Vin → S02 ON/OFF)  
 Synthesizes audio input from Vin terminal with sounds 1-4 and outputs the result.

0: No output  
 1: Output

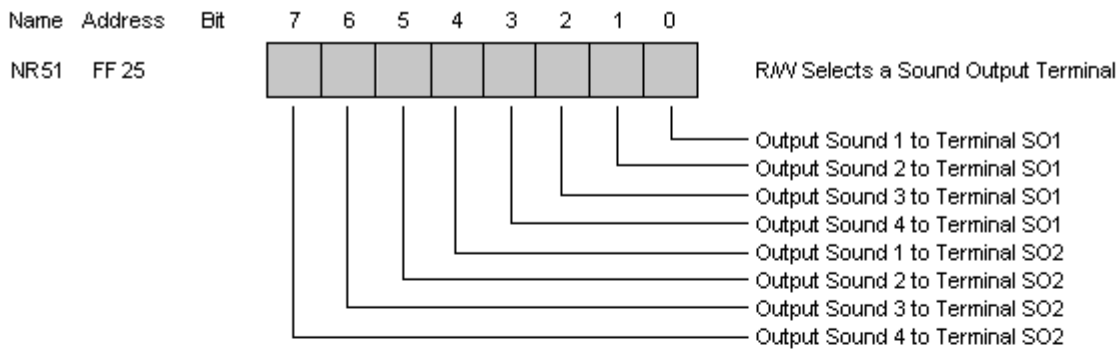

0: No Output  
 1: Output

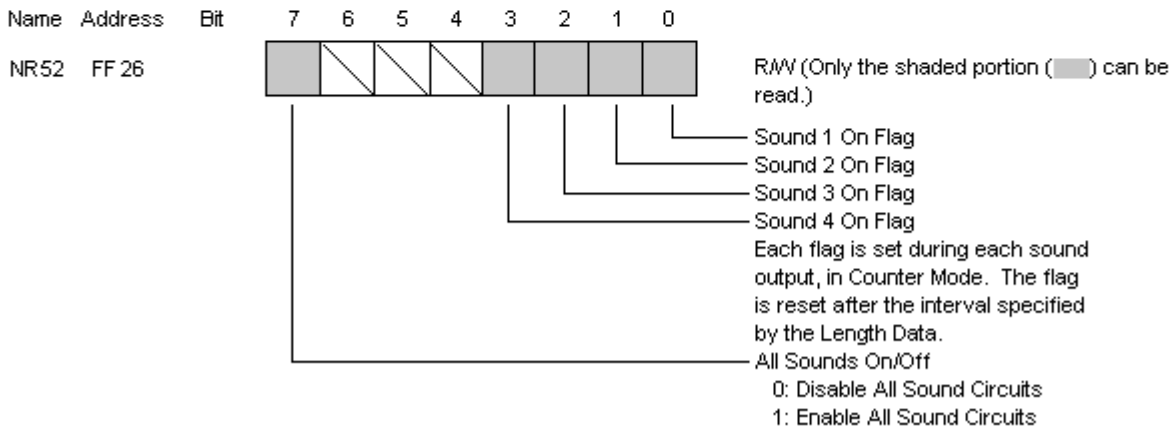



### 3. VIN TERMINAL USAGE NOTES

- The VIN terminal can be used normally only in CGB. (Since the signal from the VIN terminal is too low to be used, the VIN terminal cannot be used in DMG.)
- The maximum amplitude of the synthesized output is 3V.
- The design prevents the maximum amplitude from exceeding 3V when only sounds 1-4 are used, even when the output level for each sound is set to the maximum.

When the output level is set to 0x0F, each sound is output at 0.75V.

$$0.75V \times 4 = 3V$$

- The maximum amplitude of the synthesized sound output also must be limited to 3V or less when the VIN terminal is used to input external sound.

Example: Using Sounds 1-4 and the VIN terminal

Use software to adjust the output levels of sounds 1-4 so that they do not exceed 0.6V (3V ÷). Also limit the output level of the VIN terminal to 0.6V or less (input range of 1.9 - 2.5V).

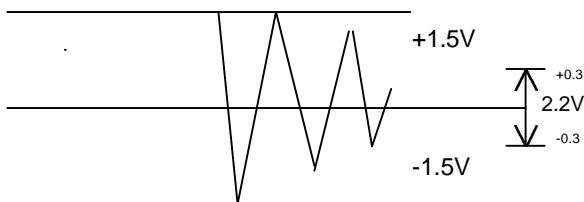

- The input voltage from the VIN terminal also can be increased if the levels of the internal sounds are low or if not all 4 sounds are used (total output level of 3V or less).

*THIS PAGE WAS INTENTIONALLY LEFT BLANK*

<b>Chapter 4: CPU Instruction Set.....</b>	<b>84</b>
<b>1. General Purpose Registers.....</b>	<b>84</b>
<b>2. Description of instructions.....</b>	<b>85</b>
2.1 8-Bit Transfer and Input/Output Instructions.....	85
2.2 16-Bit Transfer Instructions.....	90
2.3 8-Bit Arithmetic and Logical Operation Instructions.....	92
2.4 16-Bit Arithmetic Operation Instructions.....	97
2.5 Rotate Shift Instructions.....	98
2.6 Bit Operations.....	103
2.7 Jump Instructions.....	105
2.8 Call and Return Instructions.....	107
2.9 General-Purpose Arithmetic Operations/CPU Control Instructions.....	110





**Game Boy Programming Manual**

		CY	H	H	Z	CYCL	7	6	5	4	3	2	1	0
LD	(HL), r	(HL) ← r	--	--	--	--	2	01	110	r				

Stores the contents of register r in memory specified by register pair HL.

Example: When A = 0x3CH, HL = 0x8AC5  
 LD (HL), A ; (0x8AC5) ← 0x3C

		CY	H	H	Z	CYCL	7	6	5	4	3	2	1	0
LD	(HL), n	(HL) ← n	--	--	--	--	3	00	110	110				
											← n →			

Loads 8-bit immediate data n into memory specified by register pair HL.

Example: When HL = 0x8AC5,  
 LD (HL), 0 ; 0x8AC5 ← 0

		CY	H	H	Z	CYCL	7	6	5	4	3	2	1	0
LD	A, (BC)	A ← (BC)	--	--	--	--	2	00	001	010				

Loads the contents specified by the contents of register pair BC into register A.

Example: When (BC) = 0x2F,  
 LD A, (BC) ; A ← 0x2F

		CY	H	H	Z	CYCL	7	6	5	4	3	2	1	0
LD	A, (DE)	A ← (DE)	--	--	--	--	2	00	011	010				

Loads the contents specified by the contents of register pair DE into register A.

Example: When (DE) = 0x5F,  
 LD A, (DE) ; A ← 0x5F

		CY	H	H	Z	CYCL	7	6	5	4	3	2	1	0
LD	A, (C)	A ← (FF00H+C)	--	--	--	--	2	11	110	010				

Loads into register A the contents of the internal RAM, port register, or mode register at the address in the range 0xFF00-0xFFFF specified by register C.

Example: When C = 0x95,  
 LD A, (C) ; A ← contents of (0xFF95)

		CY	M	H	Z	CYCL	7	6	5	4	3	2	1	0
LD	(C), A	(FF00H+C) ← A	--	--	--	--	2	11	100	010				

Loads the contents of register A in the internal RAM, port register, or mode register at the address in the range 0xFF00-0xFFFF specified by register C.

Example: When C = 0x9F,  
LD (C), A ; (0xFF9F) ← A

		CY	M	H	Z	CYCL	7	6	5	4	3	2	1	0
LD	A, (n)	A ← (n)	--	--	--	--	3	11	110	000				
											← n →			

Loads into register A the contents of the internal RAM, port register, or mode register at the address in the range 0xFF00-0xFFFF specified by the 8-bit immediate operand n.

Note, however, that a 16-bit address should be specified for the mnemonic portion of n, because only the lower-order 8 bits are automatically reflected in the machine language.

Example: To load data at 0xFF34 into register A, type the following.  
LD A, (FF34)

Typing only LD A, (34) would cause the address to be incorrectly interpreted as 0034, resulting in the instruction LD A, (0034).

		CY	M	H	Z	CYCL	7	6	5	4	3	2	1	0
LD	(n), A	(n) ← A	--	--	--	--	3	11	100	000				
											← n →			

Loads the contents of register A to the internal RAM, port register, or mode register at the address in the range 0xFF00-0xFFFF specified by the 8-bit immediate operand n.

Note, however, that a 16-bit address should be specified for the mnemonic portion of n, because only the lower-order 8 bits are automatically reflected in the machine language.

Example: To load the contents of register A in 0xFF34, type the following.  
LD (FF34), A

Typing only LD (34), A would cause the address to be incorrectly interpreted as 0034, resulting in the instruction LD (0034), A.

		CY	M	H	Z	CYCL	7	6	5	4	3	2	1	0
LD	A, (nn)	A ← (nn)	--	--	--	--	4	11	111	010				
											← n →			
											← n →			

Loads into register A the contents of the internal RAM or register specified by 16-bit immediate operand nn.

Example: LD A, (0xFF44) ; A ← (LY)  
LD A, (0x8000) ; A ← (0x8000)

		CY	H	H	Z	CYCL	7	6	5	4	3	2	1	0
LD	(nn), A	(nn) ← A	--	--	--	--	4	11	101	010				
											← n →			
											← n →			

Loads the contents of register A to the internal RAM or register specified by 16-bit immediate operand nn.

Example: LD (0xFF44), A ; (LY) ← A  
 LD (0x8000), A ; (0x8000) ← A

		CY	H	H	Z	CYCL	7	6	5	4	3	2	1	0
LD	A, (HLI)	A ← (HL) HL ← HL+1	--	--	--	--	2	00	101	010				

Loads in register A the contents of memory specified by the contents of register pair HL and simultaneously increments the contents of HL.

Example: When HL = 0x1FF and (0x1FF) = 0x56,  
 LD A, (HLI) ; A ← 0x56, HL ← 0x200

		CY	H	H	Z	CYCL	7	6	5	4	3	2	1	0
LD	A, (HLD)	A ← (HL) HL ← HL-1	--	--	--	--	2	00	111	010				

Loads in register A the contents of memory specified by the contents of register pair HL and simultaneously decrements the contents of HL.

Example: When HL = 0x8A5C and (0x8A5C) = 0x3C,  
 LD A, (HLD) ; A ← 0x3C, HL ← 0x8A5B

		CY	H	H	Z	CYCL	7	6	5	4	3	2	1	0
LD	(BC), A	(BC) ← A	--	--	--	--	2	00	000	010				

Stores the contents of register A in the memory specified by register pair BC.

Example: When BC = 0x205F and A = 0x3F,  
 LD (BC), A ; (0x205F) ← 0x3F

		CY	H	H	Z	CYCL	7	6	5	4	3	2	1	0
LD	(DE), A	(DE) ← A	--	--	--	--	2	00	010	010				

Stores the contents of register A in the memory specified by register pair DE.

Example: When DE = 0x205C and A = 0x00,  
 LD (DE), A ; (0x205C) ← 0x00



		CY	H	H	Z	CYCL	7	6	5	4	3	2	1	0
LD	(HLI), A	--	--	--	--	2	00	100	010					
		(HL) ← A		HL ← HL+1										

Stores the contents of register A in the memory specified by register pair HL and simultaneously increments the contents of HL.

Example: When HL = 0xFFFF and A = 0x56,  
LD (HL), A ; (0xFFFF) ← 0x56, HL = 0x0000

		CY	H	H	Z	CYCL	7	6	5	4	3	2	1	0
LD	(HLD), A	--	--	--	--	2	00	110	010					
		(HL) ← A		HL ← HL-1										

Stores the contents of register A in the memory specified by register pair HL and simultaneously decrements the contents of HL.

Example: HL = 0x4000 and A = 0x5,  
LD (HLD), A ; (0x4000) ← 0x5, HL = 0x3FFF

### 2.2 16-Bit Transfer Instructions

	LD	dd, nn	dd ← nn	CY	H	H	Z	CYCL	7 6 5 4 3 2 1 0
				--	--	--	--	3	00 dd0 001
									L-ADRS ← n →
									H-ADRS ← n →

Loads 2 bytes of immediate data to register pair dd.

dd codes are as follows:

Register Pair	dd
BC	00
DD	01
HL	10
SP	11

Example: LD HL, 0x3A5B ; H ← 0x3A, L ← 0x5B

	LD	SP, HL	SP ← HL	CY	H	H	Z	CYCL	7 6 5 4 3 2 1 0
				--	--	--	--	2	11 111 001

Loads the contents of register pair HL in stack pointer SP.

	PUSH	qq	(SP - 1) ← qqH (SP - 2) ← qqL SP ← SP - 2	CY	H	H	Z	CYCL	7 6 5 4 3 2 1 0
				--	--	--	--	4	11 qq0 101

Pushes the contents of register pair qq onto the memory stack. First 1 is subtracted from SP and the contents of the higher portion of qq are placed on the stack. The contents of the lower portion of qq are then placed on the stack. The contents of SP are automatically decremented by 2.

qq codes are as follows:

Register Pair	qq
BC	00
DE	01
HL	10
AF	11

Example: When SP = 0xFFFE,  
PUSH BC ; (0xFFFC), (0xFFFC) ← B, SP ← 0xFFFC

		CY	H	H	Z	CYCL	7	6	5	4	3	2	1	0
POP	qq	--	--	--	--	3	11	qq0	001					
		$qqL \leftarrow (SP)$ $qqH \leftarrow (SP+1)$ $SP \leftarrow SP+2$												

Pops contents from the memory stack and into register pair qq. First the contents of memory specified by the contents of SP are loaded in the lower portion of qq. Next, the contents of SP are incremented by 1 and the contents of the memory they specify are loaded in the upper portion of qq. The contents of SP are automatically incremented by 2.

Example: When  $SP = 0xFFFC$ ,  $(0xFFFC) = 0x5F$ , and  $(0xFFFD) = 0x3C$ ,  
 POP BC ;  $B \leftarrow 0x3C$ ,  $C \leftarrow 0x5F$ ,  $SP \leftarrow 0xFFE$

		CY	H	H	Z	CYCL	7	6	5	4	3	2	1	0
LDHL	SP, e	*	*	0	0	3	11	111	000					
							* Varies with instruction results			← e →				

e = -128 to +127

The 8-bit operand e is added to SP and the result is stored in HL.

Flag  
 Z: Reset  
 H: Set if there is a carry from bit 11; otherwise reset.  
 N: Reset  
 CY: Set if there is a carry from bit 15; otherwise reset.

Example: When  $SP = 0xFFF8$ ,  
 LDHL SP, 2 ;  $HL \leftarrow 0xFFFA$ ,  $CY \leftarrow 0$ ,  $H \leftarrow 0$ ,  $N \leftarrow 0$ ,  $Z \leftarrow 0$

		CY	H	H	Z	CYCL	7	6	5	4	3	2	1	0
LD	(nn), SP	--	--	--	--	5	00	001	000					
							L-ADRS			← n →				
							H-ADRS			← n →				
		$(nn) \leftarrow SP_L$ $(nn+1) \leftarrow SP_H$												

Stores the lower byte of SP at address nn specified by the 16-bit immediate operand nn and the upper byte of SP at address nn + 1.

Example: When  $SP = 0xFFF8$ ,  
 LD (0xC100), SP ;  $0xC100 \leftarrow 0xF8$   
 $0xC101 \leftarrow 0xFF$

2.3 8-Bit Arithmetic and Logical Operation Instructions

				CY	H	H	Z	CYCL	7	6	5	4	3	2	1	0
ADD	A,	r	$A \leftarrow A+r$	*	*	0	*	1	10	000	r					

Adds the contents of register r to those of register A and stores the results in register A.

Flag  
 Z: Set if the result is 0; otherwise reset.  
 H: Set if there is a carry from bit 3; otherwise reset.  
 N: Reset  
 CY: Set if there is a carry from bit 7; otherwise reset.

Example: When A = 0x3A and B = 0xC6,  
 ADD A, B ;  $A \leftarrow 0$ ,  $Z \leftarrow 1$ ,  $H \leftarrow 1$ ,  $N \leftarrow 0$ ,  $CY \leftarrow 1$

				CY	H	H	Z	CYCL	7	6	5	4	3	2	1	0
ADD	A,	n	$A \leftarrow A+n$	*	*	0	*	2	11	000	110					
										← n →						

Adds 8-bit immediate operand n to the contents of register A and stores the results in register A.

Example: When A = 0x3C,  
 ADD A, 0xFF ;  $A \leftarrow 0x3B$ ,  $Z \leftarrow 0$ ,  $H \leftarrow 1$ ,  $N \leftarrow 0$ ,  $CY \leftarrow 1$

				CY	H	H	Z	CYCL	7	6	5	4	3	2	1	0
ADD	A,	(HL)	$A \leftarrow A+(HL)$	*	*	0	*	2	10	000	110					

Adds the contents of memory specified by the contents of register pair HL to the contents of register A and stores the results in register A.

Example: When A = 0x3C and (HL) = 0x12,  
 ADD A, (HL) ;  $A \leftarrow 0x4E$ ,  $Z \leftarrow 0$ ,  $H \leftarrow 0$ ,  $N \leftarrow 0$ ,  $CY \leftarrow 0$

				CY	H	H	Z	CYCL	7	6	5	4	3	2	1	0
ADC	A,	s	$A \leftarrow A+s+CY$	*	*	0	*	--	--	--	--					

Adds the contents of operand s and CY to the contents of register A and stores the results in register A.  
 r, n, and (HL) are used for operand s.

				CYCL	7	6	5	4	3	2	1	0
ADC	A,	r		1	10	001	r					
ADC	A,	n		2	11	001	110					
										← n □ → □		
ADC	A,	(HL)		2	10	001	110					

Examples: When A = 0xE1, E = 0x0F, (HL) = 0x1E, and CY = 1,  
 ADC A, E ;  $A \leftarrow 0xF1$ ,  $Z \leftarrow 0$ ,  $H \leftarrow 1$ ,  $CY \leftarrow 0$   
 ADC A, 0x3B ;  $A \leftarrow 0x1D$ ,  $Z \leftarrow 0$ ,  $H \leftarrow 0$ ,  $CY \leftarrow -1$   
 ADC A, (HL) ;  $A \leftarrow 0x00$ ,  $Z \leftarrow 1$ ,  $H \leftarrow 1$ ,  $CY \leftarrow 1$

			CY	H	H	Z	CYCL	7	6	5	4	3	2	1	0
SUB	s	$A \leftarrow A-s$	*	*	1	*	--	--	--	--	--	--	--	--	--

Subtracts the contents of operand *s* from the contents of register *A* and stores the results in register *A*.  
*r*, *n*, and (HL) are used for operand *s*.

			CYCL	7	6	5	4	3	2	1	0	
SUB	<i>r</i>		1	10	010					<i>r</i>		
SUB	<i>n</i>		2	11	010					110		
				← <i>n</i> →								
SUB	(HL)		2	10	010					110		

Flag            Z: Set if result is 0; otherwise reset.  
                   H: Set if there is a borrow from bit 4; otherwise reset.  
                   N: Set  
                   CY: Set if there is a borrow; otherwise reset.

Examples: When  $A = 0x3E$ ,  $E = 0x3E$ , and  $(HL) = 0x40$ ,  
 SUB *E*    ;  $A \leftarrow 0x00$ ,  $Z \leftarrow 1$ ,  $H \leftarrow 0$ ,  $N \leftarrow 1$   $CY \leftarrow 0$   
 SUB  $0x0F$  ;  $A \leftarrow 0x2F$ ,  $Z \leftarrow 0$ ,  $H \leftarrow 1$ ,  $N \leftarrow 1$   $CY \leftarrow 0$   
 SUB (HL) ;  $A \leftarrow 0xFE$ ,  $Z \leftarrow 0$ ,  $H \leftarrow 0$ ,  $N \leftarrow 1$   $CY \leftarrow 1$

			CY	H	H	Z	CYCL	7	6	5	4	3	2	1	0
SBC	<i>A</i> , <i>s</i>	$A \leftarrow A-s-CY$	*	*	1	*	--	--	--	--	--	--	--	--	--

Subtracts the contents of operand *s* and *CY* from the contents of register *A* and stores the results in register *A*.  
*r*, *n*, and (HL) are used for operand *s*.

			CYCL	7	6	5	4	3	2	1	0	
SBC	<i>A</i> , <i>r</i>		1	10	011					<i>r</i>		
SBC	<i>A</i> , <i>n</i>		2	11	011					110		
				← <i>n</i> →								
SBC	<i>A</i> , (HL)		2	10	011					110		

Examples: When  $A = 0x3B$ ,  $(HL) = 0x4F$ ,  $H = 0x2A$ , and  $CY = 1$ ,  
 SBC *A*, *H* ;  $A \leftarrow 0x10$ ,  $Z \leftarrow 0$ ,  $H \leftarrow 0$ ,  $N \leftarrow 1$   $CY \leftarrow 0$   
 SBC *A*,  $0x3A$  ;  $A \leftarrow 0x00$ ,  $Z \leftarrow 1$ ,  $H \leftarrow 0$ ,  $N \leftarrow 1$   $CY \leftarrow 0$   
 SBC *A*, (HL) ;  $A \leftarrow 0xEB$ ,  $Z \leftarrow 0$ ,  $H \leftarrow 1$ ,  $N \leftarrow 1$   $CY \leftarrow 1$

			CY	H	H	Z	CYCL	7	6	5	4	3	2	1	0
AND	<i>s</i>	$A \leftarrow A \wedge s$	0	1	0	*	--	--	--	--	--	--	--	--	--

Takes the logical-AND for each bit of the contents of operand *s* and register *A*. and stores the results in register *A*.  
*r*, *n*, and (HL) are used for operand *s*.

		CYCL				7	6	5	4	3	2	1	0
AND	r	1	10	100	r								
AND	n	2	11	100	110								
				← n →									
AND	(HL)	2	10	100	110								

Examples: When A = 0x5A, L = 0x3F and (HL) = 0x0,  
 AND L ; A ← 0x1A, Z ← 0, H ← 1, N ← 0 CY ← 0  
 AND 0x38 ; A ← 0x18, Z ← 0, H ← 1, N ← 0 CY ← 0  
 AND (HL) ; A ← 0x00, Z ← 1, H ← 1, N ← 0 CY ← 0

		CY				N	H	Z	CYCL				7	6	5	4	3	2	1	0
OR	s	AVs	0	0	0	*	--	--	--	--	--	--	--	--	--	--	--	--	--	

Takes the logical-OR for each bit of the contents of operand s and register A and stores the results in register A. r, n, and (HL) are used for operand s.

		CYCL				7	6	5	4	3	2	1	0
OR	r	1	10	110	r								
OR	n	2	11	110	110								
				← n →									
OR	(HL)	2	10	110	110								

Examples: When A = 0x5A, (HL) = 0x0F,  
 OR A ; A ← 0x5A, Z ← 0  
 OR 3 ; A ← 0x5B, Z ← 0  
 OR (HL) ; A ← 0x5F, Z ← 0

		CY				N	H	Z	CYCL				7	6	5	4	3	2	1	0
XOR	s	A ⊕ s	0	0	0	*	--	--	--	--	--	--	--	--	--	--	--	--	--	

Takes the logical exclusive-OR for each bit of the contents of operand s and register A, and stores the results in register A. r, n, and (HL) are used for operand s.

		CYCL				7	6	5	4	3	2	1	0
XOR	r	1	10	101	r								
XOR	n	2	11	101	110								
				← n →									
XOR	(HL)	2	10	101	110								

Examples: When A = 0xFF and (HL) = 0x8A,  
 XOR A ; A ← 0x00, Z ← 1  
 XOR 0x0F ; A ← 0xF0, Z ← 0  
 XOR (HL) ; A ← 0x75, Z ← 0

		CY				CYCL								
		CY	H	H	Z	CYCL	7	6	5	4	3	2	1	0
CP	s	A ← s	*	*	1	*	--	--	--	--	--	--	--	--

Compares the contents of operand s and register A and sets the flag if they are equal.  
 r, n, and (HL) are used for operand s.

		CYCL								
		CYCL	7	6	5	4	3	2	1	0
CP	r	1	10	111	r					
CP	n	2	11	111	110					
				← n →						
CP	(HL)	2	10	111	110					

Examples: When A = 0x3C, B = 0x2F, and (HL) = 0x40,  
 CP B ; Z ← 0, H ← 1, N ← 1, CY ← 0  
 CP 0x3C ; Z ← 1, H ← 0, N ← 1, CY ← 0  
 CP (HL) ; Z ← 0, H ← 0, N ← 1, CY ← 1

		CY				CYCL								
		CY	H	H	Z	CYCL	7	6	5	4	3	2	1	0
INC	r	r ← r + 1	--	*	0	*	1	00	r	100				

Increments the contents of register r by 1.

Example: When A = 0xFF,  
 INC A ; A ← 0, Z ← 1, H ← 1, N ← 0

		CY				CYCL								
		CY	H	H	Z	CYCL	7	6	5	4	3	2	1	0
INC	(HL)	(HL) ← (HL) + 1	--	*	0	*	3	00	110	100				

Increments by 1 the contents of memory specified by register pair HL.

Example: When (HL) = 0x50,  
 INC (HL) ; (HL) ← 0x51, Z ← 0, H ← 0, N ← 0

		CY				CYCL								
		CY	H	H	Z	CYCL	7	6	5	4	3	2	1	0
DEC	r	r ← r - 1	--	*	1	*	1	00	r	101				

Subtract 1 from the contents of register r by 1.

Example: When L = 0x01,  
 DEC L ; L ← 0, Z ← 1, H ← 0, N ← 1

			CY	H	H	Z	CYCL	7	6	5	4	3	2	1	0
DEC	(HL)	(HL) ← (HL) - 1	--	*	1	*	3	00	110	101					

Increments by 1 the contents of memory specified by register pair HL.

Example: When (HL) = 0x00,  
 DEC (HL) ; (HL) ← 0xFF, Z ← 0, H ← 1, N ← 1



2.4 16-Bit Arithmetic Operation Instructions

				CY	H	H	Z	CYCL	7	6	5	4	3	2	1	0
ADD	HL, ss	HL ← HL + ss		*	*	0	--	2	00	ss1			001			

Adds the contents of register pair ss to the contents of register pair HL and stores the results in HL.

**ss** codes are as follows.

Register Pair	ss
BC	00
DE	01
HL	10
SP	11

Flag            Z: No change  
                   H: Set if there is a carry from bit 11; otherwise reset.  
                   N: Rest  
                   CY: Set if there is a carry from bit 15; otherwise reset.

Example: When HL = 0x8A23, BC = 0x0605,  
             ADD HL, BC ; HL ← 0x9028, H ← 1, N ← 0, CY ← 0  
             ADD HL, HL ; HL ← 0x1446, H ← 1, N ← 0, CY ← 1

				CY	H	H	Z	CYCL	7	6	5	4	3	2	1	0
ADD	SP, e	SP ← SP + e		*	*	0	0	4	11	101			000			
													← e →			

Adds the contents of the 8-bit immediate operand e and SP and stores the results in SP.

Example: SP = 0xFFFF  
             ADD SP, 2 ; SP ← 0xFFFFA, CY ← 0, H ← 0, N ← 0, Z ← 0

				CY	H	H	Z	CYCL	7	6	5	4	3	2	1	0
INC	ss	ss ← ss + 1		--	--	--	--	2	00	ss0			011			

Increments the contents of register pair ss by 1.

Example: When DE = 0x235F,  
             INC DE ; DE ← 0x2360

				CY	H	H	Z	CYCL	7	6	5	4	3	2	1	0
DEC	ss	ss ← ss - 1		--	--	--	--	2	00	ss1			011			

Decrements the contents of register pair ss by 1.

Example: When DE = 0x235F,  
             DEC DE ; DE ← 0x235E

### 2.5 Rotate Shift Instructions

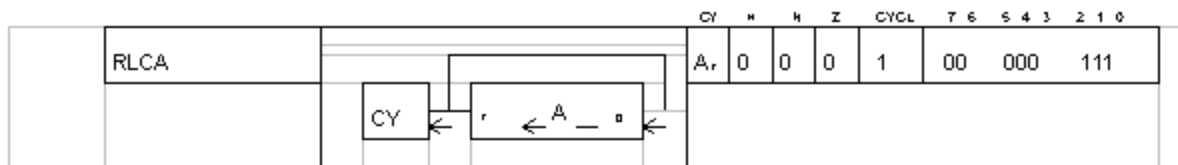

Rotates the contents of register A to the left. That is, the contents of bit 0 are copied to bit 1 and the previous contents of bit 1 (the contents before the copy operation) are copied to bit 2. The same operation is repeated in sequence for the rest of the register. The contents of bit 7 are placed in both CY and bit 0 of register A.

Example: When A = 0x85 and CY = 0,  
 RLCA ; A ← 0x0A, CY ← 1, Z ← 0, H ← 0, N ← 0

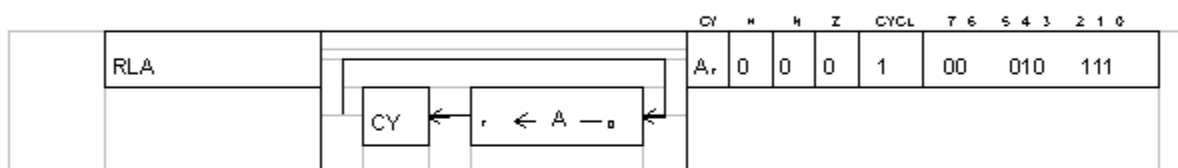

Rotates the contents of register A to the left.

Example: When A = 0x95 and CY = 1,  
 RLA ; A ← 0x2B, C ← 1, Z ← 0, H ← 0, N ← 0

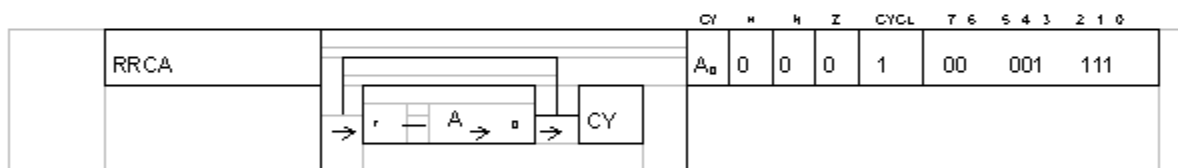

Rotates the contents of register A to the right.

Example: When A = 0x3B and CY = 0,  
 RRCA ; A ← 0x9D, CY ← 1, Z ← 0, H ← 0, N ← 0

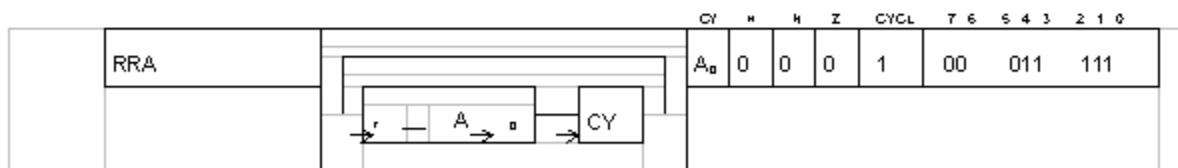

Rotates the contents of register A to the right.

Example: When A = 0x81 and CY = 0,  
 RRA ; A ← 0x40, CY ← 1, Z ← 0, H ← 0, N ← 0

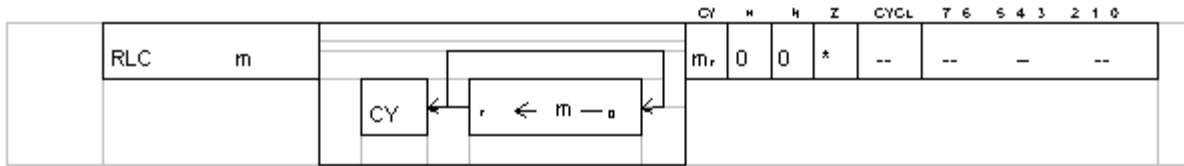

Rotates the contents of operand m to the left.  
r and (HL) are used for operand m.

		CYCL 7 6 5 4 3 2 1 0						
RLC	r	2	11	001	011			
			00	000	r			
RLC	(HL)	4	11	001	011			
			00	000	110			

Examples: When B = 0x85, (HL) = 0, and CY = 0,  
 RLC B ; B ← 0x0B, CY ← 1, Z ← 0, H ← 0, N ← 0  
 RLC (HL) ; (HL) ← 0x00, CY ← 0, Z ← 1, H ← 0, N ← 0

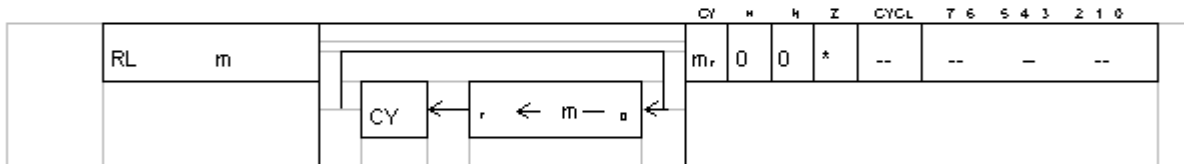

Rotates the contents of operand m to the left.  
r and (HL) are used for operand m.

		CYCL 7 6 5 4 3 2 1 0						
RL	r	2	11	001	011			
			00	010	r			
RL	(HL)	4	11	001	011			
			00	010	110			

Examples: When L = 0x80, (HL) = 0x11, and CY = 0,  
 RL L ; L ← 0x00, CY ← 1, Z ← 1, H ← 0, N ← 0  
 RL (HL) ; (HL) ← 0x22, CY ← 0, Z ← 0, H ← 0, N ← 0

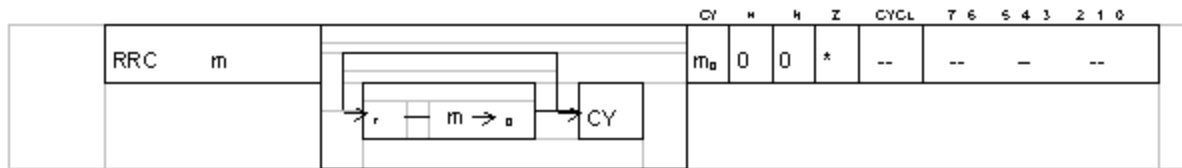

Rotates the contents of operand *m* to the right. *r* and (HL) are used for operand *m*.

		CYCL	7	6	5	4	3	2	1	0
RRC	<i>r</i>	2	11	001	011					
			00	001	<i>r</i>					
RRC	(HL)	4	11	001	011					
			00	001	110					

Examples: When  $C = 0x1$ ,  $(HL) = 0x0$ ,  $CY = 0$ ,  
 $RRC\ C$  ;  $C \leftarrow 0x80, CY \leftarrow 1, Z \leftarrow 0, H \leftarrow 0, N \leftarrow 0$   
 $RRC\ (HL)$  ;  $(HL) \leftarrow 0x00, CY \leftarrow 0, Z \leftarrow 1, H \leftarrow 0, N \leftarrow 0$

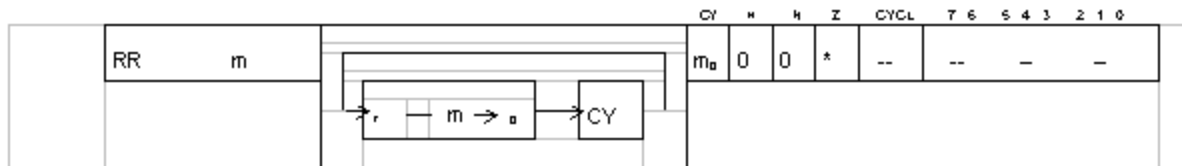

Rotates the contents of operand *m* to the right. *r* and (HL) are used for operand *m*.

		CYCL	7	6	5	4	3	2	1	0
RR	<i>r</i>	2	11	001	011					
			00	011	<i>r</i>					
RR	(HL)	4	11	011	011					
			00	011	110					

Examples: When  $A = 0x1$ ,  $(HL) = 0x8A$ ,  $CY = 0$ ,  
 $RR\ A$  ;  $A \leftarrow 0x00, CY \leftarrow 1, Z \leftarrow 1, H \leftarrow 0, N \leftarrow 0$   
 $RR\ (HL)$  ;  $(HL) \leftarrow 0x45, CY \leftarrow 0, Z \leftarrow 0, H \leftarrow 0, N \leftarrow 0$

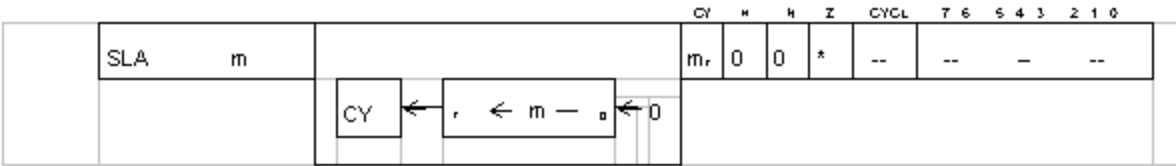

Shifts the contents of operand *m* to the left. That is, the contents of bit 0 are copied to bit 1 and the previous contents of bit 1 (the contents before the copy operation) are copied to bit 2. The same operation is repeated in sequence for the rest of the operand. The content of bit 7 is copied to CY, and bit 0 is reset.

*r* and (HL) are used for operand *m*.

		CYCL	7	6	5	4	3	2	1	0
SLA	<i>r</i>	2	11	001	011					
			00	100	<i>r</i>					
SLA	(HL)	4	11	011	011					
			00	100	110					

Examples: When *D* = 0x80, (HL) = 0xFF, and CY = 0,  
 SLA *D* ; *D* ← 0x00, CY ← 1, Z ← 1, H ← 0, N ← 0  
 SLA (HL) ; (HL) ← 0xFE, CY ← 1, Z ← 0, H ← 0, N ← 0

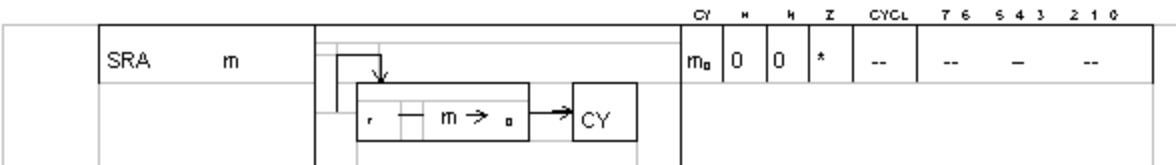

Shifts the contents of operand *m* to the right. That is, the contents of bit 7 are copied to bit 6 and the previous contents of bit 6 (the contents before the copy operation) are copied to bit 5. The same operation is repeated in sequence for the rest of the operand. The contents of bit 0 are copied to CY, and the content of bit 7 is unchanged.

*r* and (HL) are used for operand *m*.

		CYCL	7	6	5	4	3	2	1	0
SRA	<i>r</i>	2	11	001	011					
			00	101	<i>r</i>					
SRA	(HL)	4	11	001	011					
			00	101	110					

Example: When *A* = 0x8A, (HL) = 0x01, and CY = 0,  
 SRA *D* ; *A* ← 0xC5, CY ← 0, Z ← 0, H ← 0, N ← 0  
 SRA (HL) ; (HL) ← 0x00, CY ← 1, Z ← 1, H ← 0, N ← 0

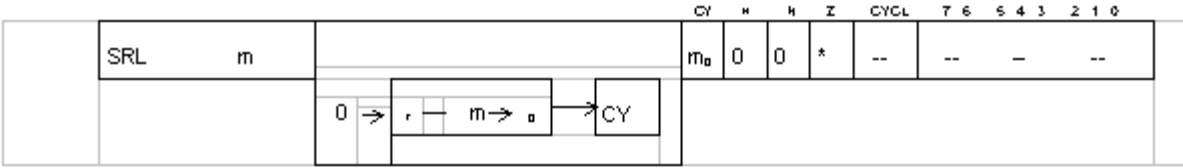

Shifts the contents of operand *m* to the right. That is, the contents of bit 7 are copied to bit 6 and the previous contents of bit 6 (the contents before the copy operation) are copied to bit 5. The same operation is repeated in sequence for the rest of the operand. The contents of bit 0 are copied to CY, and bit 7 is reset.

*r* and (HL) are used for operand *m*.

		CYCL 7 6 5 4 3 2 1 0						
SRL	<i>r</i>	2	11	001	011			
			00	111	<i>r</i>			
SRL	(HL)	4	11	001	011			
			00	111	110			

Examples: When *A* = 0x01, (HL) = 0xFF, CY = 0,  
 SRL *A* ; *A* ← 0x00, CY ← 1, Z ← 1, H ← 0, N ← 0  
 SRL (HL) ; (HL) ← 0x7F, CY ← 1, Z ← 0, H ← 0, N ← 0

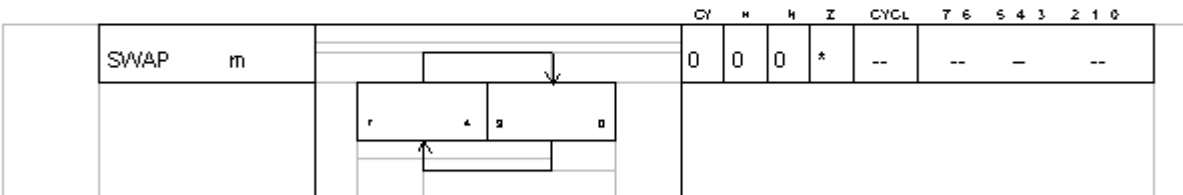

Shifts the contents of the lower-order 4 bits (0-3) of operand *m* unmodified to the higher-order 4 bits (4-7) of that operand and shifts the contents of the higher-order 4 bits to the lower-order 4 bits.  
*r* and (HL) are used for operand *m*.

		CYCL 7 6 5 4 3 2 1 0						
SWAP	<i>r</i>	2	11	001	011			
			00	110	<i>r</i>			
SWAP	(HL)	4	11	001	011			
			00	110	110			

Examples: When *A* = 0x00 and (HL) = 0xF0,  
 SWAP *A* ; *A* ← 0x00, Z ← 1, H ← 0, N ← 0, CY ← 0  
 SWAP (HL) ; (HL) ← 0x0F, Z ← 0, H ← 0, N ← 0, CY ← 0

## 2.6 Bit Operations

				CY	H	H	Z	CYCL	7	6	5	4	3	2	1	0
BIT	b, r	$Z \leftarrow \overline{b}$		--	1	0	$\overline{b}$	2	11	001	011					
										01	b	r				

Copies the complement of the contents of the specified bit in register r to the Z flag of the program status word (PSW).

The codes for b and r are as follows.

Bit	b	Register	r
0	000	A	111
1	001	B	000
2	010	C	001
3	011	D	010
4	100	E	011
5	101	H	100
6	110	L	101
7	111		

Examples: When A= 0x80 and L= 0xEF  
 BIT 7, A ;  $Z \leftarrow 0, H \leftarrow 1, N \leftarrow 0$   
 BIT 4, L ;  $Z \leftarrow 1, H \leftarrow 1, N \leftarrow 0$

				CY	H	H	Z	CYCL	7	6	5	4	3	2	1	0
BIT	b, (HL)	$Z \leftarrow \overline{(HL)_b}$		--	1	0	$\overline{(HL)_b}$	3	11	001	011					
										01	b	110				

Copies the complement of the contents of the specified bit in memory specified by the contents of register pair HL to the Z flag of the program status word (PSW).

Examples: When (HL) = 0xFE,  
 BIT 0, (HL) ;  $Z \leftarrow 1, H \leftarrow 1, N \leftarrow 0$   
 BIT 1, (HL) ;  $Z \leftarrow 0, H \leftarrow 1, N \leftarrow 0$

				CY	H	H	Z	CYCL	7	6	5	4	3	2	1	0
SET	b, r	$r_b \leftarrow 1$		--	--	--	--	2	11	001	011					
										11	b	r				

Sets to 1 the specified bit in specified register r.

**Game Boy Programming Manual**

Example: When A= 0x80 and L= 0x3B,  
 SET 3, A ; A ← 0x84  
 SET 7, L ; L ← 0xBB

				CY	M	H	Z	CYCL	7	6	5	4	3	2	1	0
SET	b,	(HL)	(HL) <sub>b</sub> ← 1	--	--	--	--	4	11		001			011		
									11		b			110		

Sets to 1 the specified bit in the memory contents specified by registers H and L.

Example: When 0x00 is the memory contents specified by H and L,  
 SET 3, (HL) ; (HL) ← 04H

				CY	M	H	Z	CYCL	7	6	5	4	3	2	1	0
RES	b,	r	r <sub>b</sub> ← 0	--	--	--	--	2	11		001			011		
									10		b			r		

Resets to 0 the specified bit in the specified register r.

Example: When A= 0x80 and L= 0x3B,  
 RES 7, A ; A ← 0x00  
 RES 1, L ; L ← 0x39

				CY	M	H	Z	CYCL	7	6	5	4	3	2	1	0
RES	b,	(HL)	(HL) <sub>b</sub> ← 0	--	--	--	--	4	11		001			011		
									10		b			110		

Resets to 0 the specified bit in the memory contents specified by registers H and L.

Example: When 0xFF is the memory contents specified by H and L,  
 RES 3, (HL) ; (HL) ← 0xF7



2.7 Jump Instructions

	JP	nn	PC ← nn	CY	N	H	Z	CYCL	7	6	5	4	3	2	1	0
				--	--	--	--	4	11	000	011					
												← n →				
												← n →				

Loads the operand nn to the program counter (PC).

nn specifies the address of the subsequently executed instruction.

The lower-order byte is placed in byte 2 of the object code and the higher-order byte is placed in byte 3.

Example: JP 8000H ; Jump to 0x8000.

	JP	cc, nn	If cc true, PC ← nn	CY	N	H	Z	CYCL	7	6	5	4	3	2	1	0
				--	--	--	--	4/3	11	0cc	010					
												← n →				
												← n →				

\*Cycle no. is 3 when cc nonmatching

Loads operand nn in the PC if condition cc and the flag status match.

The subsequent instruction starts at address nn.

If condition cc and the flag status do not match, the contents of the PC are incremented, and the instruction following the current JP instruction is executed.

The relation between conditions and cc codes are as follows.

cc	Condition	Flag
00	NZ	Z = 0
01	Z	Z = 1
10	NC	CY = 0
11	C	CY = 1

Example: When Z = 1 and C = 0,

JP NZ, 8000H ; Moves to next instruction after 3 cycles.

JP Z, 8000H ; Jumps to address 0x8000.

JP C, 8000H ; Moves to next instruction after 3 cycles.

JP NC, 8000H ; Jumps to address 0x8000.

	JR	e	PC ← PC + e	CY	N	H	Z	CYCL	7	6	5	4	3	2	1	0
				--	--	--	--	3	00	011	000					
												← e - 2 →				

e = -127 to +129

Jumps -127 to +129 steps from the current address.

**Game Boy Programming Manual**

			CY	N	H	Z	CYCL	7	6	5	4	3	2	1	0
JR	cc, e	If cc true, PC ← PC + e	--	--	--	--	3/2	00	1cc	000					
								← e - 2 →							
e = -127 to +129															

If condition cc and the flag status match, jumps -127 to +129 steps from the current address. If cc and the flag status do not match, the instruction following the current JP instruction is executed.

			CY	N	H	Z	CYCL	7	6	5	4	3	2	1	0
JP	(HL)	PC ← HL	--	--	--	--	1	11	101	001					

Loads the contents of register pair HL in program counter PC.  
The next instruction is fetched from the location specified by the new value of PC.

Example: When HL = 0x8000,  
JP (HL) ; Jumps to 0x8000.

2.8 Call and Return Instructions

			CY	M	M	Z	CYCL	7	6	5	4	3	2	1	0
CALL	nn	(SP - 1) ← PC <sub>H</sub> (SP - 2) ← PC <sub>L</sub> PC ← nn SP ← SP - 2	--	--	--	--	6	11	001	101					
								L - ADRS	← n →						
								H - ADRS	← n →						

In memory, pushes the PC value corresponding to the instruction at the address following that of the CALL instruction to the 2 bytes following the byte specified by the current SP. Operand nn is then loaded in the PC.

The subroutine is placed after the location specified by the new PC value. When the subroutine finishes, control is returned to the source program using a return instruction and by popping the starting address of next instruction, which was just pushed, and moving it to the PC.

With the push, the current value of the SP is decremented by 1, and the higher-order byte of the PC is loaded in the memory address specified by the new SP value. The value of the SP is then again decremented by 1, and the lower-order byte of the PC is loaded in the memory address specified by that value of the SP.

The lower-order byte of the address is placed in byte 2 of the object code, and the higher-order byte is placed in byte 3.

Examples: When PC = 0x8000 and SP = 0xFFFE,  
Address  
0x8000 CALL 1234H ; Jumps to address 0x1234, and  
0x8003 (FFFDH) ← 80H  
(FFFCH) ← 03H  
SP ← FFFCH

			CY	M	M	Z	CYCL	7	6	5	4	3	2	1	0
CALL	cc, nn	If cc true, (SP - 1) ← PC <sub>H</sub> (SP - 2) ← PC <sub>L</sub> PC ← nn SP ← SP - 2	--	--	--	--	6/3	11	0cc	100					
								L-ADRS	← n →						
								H-ADRS	← n →						

If condition cc matches the flag, the PC value corresponding to the instruction following the CALL instruction in memory is pushed to the 2 bytes following the memory byte specified by the SP. Operand nn is then loaded in the PC.

Examples: When Z = 1,  
Address  
0x7FFC CALL NZ, 0x1234 ; Moves to next instruction after 3 cycles.  
0x8000 CALL Z, 0x1234 ; Pushes 0x8003 to the stack,  
0x8003 and jumps to 0x1234.

		CY	N	H	Z	CYCL	7	6	5	4	3	2	1	0
RET	PC <sub>L</sub> ← (SP) PC <sub>H</sub> ← (SP + 1) SP ← SP + 2	--	--	--	--	4	11	001	001					

Pops from the memory stack the PC value pushed when the subroutine was called, returning control to the source program.

In this case, the contents of the address specified by the SP are loaded in the lower-order byte of the PC, and the content of the SP is incremented by 1. The contents of the address specified by the new SP value are then loaded in the higher-order byte of the PC, and the SP is again incremented by 1. (The value of SP is 2 larger than before instruction execution.)

The next instruction is fetched from the address specified by the content of PC.

Examples:     Address  
               8000H   CALL 9000H  
               8003H  
               9000H  
                           RET                     ; Returns to address 0x8003

		CY	N	H	Z	CYCL	7	6	5	4	3	2	1	0
RETI	PC <sub>L</sub> ← (SP) PC <sub>H</sub> ← (SP + 1) SP ← SP + 2	--	--	--	--	4	11	011	001					

Used when an interrupt-service routine finishes.  
 The execution of this return is as follows.

The address for the return from the interrupt is loaded in program counter PC.  
 The master interrupt enable flag is returned to its pre-interrupt status.

Examples:     0x0040  
               8000H   RETI                     ; Pops the stack and returns to address 0x8001.  
               8001H   INC L                   ; An external interrupt occurs here.

		CY	N	H	Z	CYCL	7	6	5	4	3	2	1	0
RET	If cc true, PC <sub>L</sub> ← (SP) PC <sub>H</sub> ← (SP + 1) SP ← SP + 2	--	--	--	--	5/2	11	0cc	000					

If condition cc and the flag match, control is returned to the source program by popping from the memory stack the PC value pushed to the stack when the subroutine was called.

Example:     Address  
               0x8000   CALL   0x9000  
               0x8003  
  
               0x9000   CP     0  
                           RET    Z                   ; Returns to address 0x8003 if Z = 1.  
   ; Moves to next instruction after 2 cycles if Z = 0.

RST	t	$(SP - 1) \leftarrow PC_H$ $(SP - 2) \leftarrow PC_L$ $SP \leftarrow SP - 2$ $PC_H \leftarrow 0 \quad PC_L \leftarrow P$	CY	H	H	Z	CYCL	7	6	5	4	3	2	1	0
			--	--	--	--	4	11	t	111					

Pushes the current value of the PC to the memory stack and loads to the PC the page 0 memory addresses provided by operand t. Then next instruction is fetched from the address specified by the new content of PC.

With the push, the content of the SP is decremented by 1, and the higher-order byte of the PC is loaded in the memory address specified by the new SP value. The value of the SP is then again decremented by 1, and the lower-order byte of the PC is loaded in the memory address specified by that value of the SP.

The RST instruction can be used to jump to 1 of 8 addresses.

Because all of the addresses are held in page 0 memory, 0x00 is loaded in the higher-order byte of the PC, and the value of P is loaded in the lower-order byte.

The relation between the t codes and P are as follows.

Operand	t	(PC <sub>H</sub> )	P (PC <sub>L</sub> )
0	000	0x00	0x00
1	001	0x00	0x08
2	010	0x00	0x10
3	011	0x00	0x18
4	100	0x00	0x20
5	101	0x00	0x28
6	110	0x00	0x30
7	111	0x00	0x38

Example: Address 0x8000 RST 1 ; Pushes 0x8001 to the stack, and jumps to 0x0008.  
 Address 0x8001

2.9 General-Purpose Arithmetic Operations and CPU Control Instructions

		CY	H	H	Z	CYCL	7	6	5	4	3	2	1	0
DAA	Decimal adjust acc	*	0	--	*	1	00	100	111					

When performing addition and subtraction, binary coded decimal representation is used to set the contents of register A to a binary coded decimal number (BCD). The following table shows the processing that accompanies execution of the DAA instruction immediately following execution of addition (ADD and ADC) and subtraction (SUB and SBC) instructions.

Instruction before Execution	CY Contents before Execution	Bits 4-7 Register A	H Contents before Execution	Bits 0-3 Register A	Number Added to Register A	CY Contents after Execution	
ADD ADC	0	0x0- 0x9	0	0x0- 0x9	0x00	0	
	0	0x0- 0x8	0	0xA-0xF	0x06	0	
	0	0x0- 0x9	1	0x0- 0x3	0x06	0	
	0	0xA-0xF	0	0x0- 0x9	0x60	1	
	0	0x9-0xF	0	0xA-0xF	0x66	1	
	0	0xA-0xF	1	0x0- 0x3	0x66	1	
	1	0x0- 0x2	0	0x0- 0x9	0x60	1	
(N = 0)	1	0x0- 0x2	0	0xA-0xF	0x66	1	
	1	0x0- 0x3	1	0x0- 0x3	0x66	1	
	SUB	0	0x0- 0x9	0	0x0- 0x9	0x00	0
	SBC	0	0x0- 0x8	1	0x6 - 0xF	0xFA	0
(N = 1)	1	0x7-0xF	0	0x0- 0x9	0xA0	1	
	1	0x6-0xF	1	0x6 - 0xF	0x9A	1	

Examples: When A = 0x45 and B = 0x38,  
 ADD A, B ; A ← 0x7D, N ← 0  
 DAA ; A ← 0x7D + 0x06 (0x83), CY ← 0  
 SUB A, B ; A ← 0x83 - 0x38 (0x4B), N ← 1  
 DAA ; A ← 0x4B + 0xFA (0x45)

		CY	H	H	Z	CYCL	7	6	5	4	3	2	1	0
CPL	$A \leftarrow \bar{A}$	--	1	1	--	1	00	101	111					

Takes the one's complement of the contents of register A.

Example: When A = 0x35,  
 CPL ; A ← 0xCA

		CY	H	H	Z	CYCL	7	6	5	4	3	2	1	0
NOP	No operation	--	--	--	--	1	00	000	000					

Only advances the program counter by 1; performs no other operations that have an effect.

## 2.9 General-Purpose Arithmetic Operations and CPU Control Instructions

		CY	H	H	Z	CYCL	7	6	5	4	3	2	1	0
DAA	Decimal adjust acc	*	0	--	*	1	00	100	111					

When performing addition and subtraction, binary coded decimal representation is used to set the contents of register A to a binary coded decimal number (BCD). The following table shows the processing that accompanies execution of the DAA instruction immediately following execution of addition (ADD and ADC) and subtraction (SUB and SBC) instructions.

Instruction before Execution	CY Contents before Execution	Bits 4-7 Register A	H Contents before Execution	Bits 0-3 Register A	Number Added to Register A	CY Contents after Execution
ADD ADC  (N = 0)	0	0x0- 0x9	0	0x0- 0x9	0x00	0
	0	0x0- 0x8	0	0xA-0xF	0x06	0
	0	0x0- 0x9	1	0x0- 0x3	0x06	0
	0	0xA-0xF	0	0x0- 0x9	0x60	1
	0	0x9-0xF	0	0xA-0xF	0x66	1
	0	0xA-0xF	1	0x0- 0x3	0x66	1
	1	0x0- 0x2	0	0x0- 0x9	0x60	1
	1	0x0- 0x2	0	0xA-0xF	0x66	1
1	0x0- 0x3	1	0x0- 0x3	0x66	1	
SUB SBC  (N = 1)	0	0x0- 0x9	0	0x0- 0x9	0x00	0
	0	0x0- 0x8	1	0x6 - 0xF	0xFA	0
	1	0x7-0xF	0	0x0- 0x9	0xA0	1
	1	0x6-0xF	1	0x6 - 0xF	0x9A	1

Examples: When A = 0x45 and B = 0x38,  
 ADD A, B ; A ← 0x7D, N ← 0  
 DAA ; A ← 0x7D + 0x06 (0x83), CY ← 0  
 SUB A, B ; A ← 0x83 - 0x38 (0x4B), N ← 1  
 DAA ; A ← 0x4B + 0xFA (0x45)

		CY	H	H	Z	CYCL	7	6	5	4	3	2	1	0
CPL	$A \leftarrow \bar{A}$	--	1	1	--	1	00	101	111					

Takes the one's complement of the contents of register A.

Example: When A = 0x35,  
 CPL ; A ← 0xCA

		CY	H	H	Z	CYCL	7	6	5	4	3	2	1	0
NOP	No operation	--	--	--	--	1	00	000	000					

Only advances the program counter by 1; performs no other operations that have an effect.

		CY	H	H	Z	CYCL	7	6	5	4	3	2	1	0
HALT	Halt	--	--	--	--	1	01	110	110					

After a HALT instruction is executed, the system clock is stopped and HALT mode is entered. Although the system clock is stopped in this status, the oscillator circuit and LCD controller continue to operate.

In addition, the status of the internal RAM register ports remains unchanged.

HALT mode is canceled by an interrupt or reset signal.

The program counter is halted at the step after the HALT instruction. If both the interrupt request flag and the corresponding interrupt enable flag are set, HALT mode is exited, even if the interrupt master enable flag is not set.

Once HALT mode is canceled, the program starts from the address indicated by the program counter.

If the master enable flag is set, the contents of the program counter are pushed to the stack and control jumps to the starting address of the interrupt.

If the RESET terminal goes LOW in HALT mode, the mode becomes that of a normal reset.

		CY	H	H	Z	CYCL	7	6	5	4	3	2	1	0
STOP	Stop	--	--	--	--	1	00	010	000					
							00	000	000					

Execution of a STOP instruction stops both the system clock and oscillator circuit. STOP mode is entered, and the LCD controller also stops.

However, the status of the internal RAM registers ports remains unchanged.

STOP mode can be canceled by a reset signal.

If the RESET terminal goes LOW in STOP mode, it becomes that of a normal reset status.

The following conditions should be met before a STOP instruction is executed and STOP mode is entered.

- All interrupt-enable (IE) flags are reset.
- Input to P10 — P13 is LOW for all.



<b>Chapter 5: Miscellaneous General Information.....</b>	<b>114</b>
<b>1. Monitor ROM.....</b>	<b>114</b>
<b>2. Recognition Data for CGB only in ROM-registered Data.....</b>	<b>115</b>
<b>3. Power-Saving Routines for the Main Program .....</b>	<b>116</b>
<b>4. Software Created Exclusively for CGB.....</b>	<b>117</b>
<b>5. Software Created to Operate on CGB.....</b>	<b>118</b>
<b>6. Software Created to Operate on CGB: Example.....</b>	<b>119</b>
<b>6.1 Program Specifications.....</b>	<b>119</b>
<b>6.2 CGB Recognition Method.....</b>	<b>120</b>
<b>6.3 Flowcharts.....</b>	<b>121</b>

## CHAPTER 5: MISCELLANEOUS GENERAL INFORMATION

### 1. MONITOR ROM

The DMG and CGB CPU includes internal monitor ROM.

When power on the hardware is turned on, the monitor ROM checks for errors in the 'Nintendo' logo character data within the game software.

If the data is correct, the Nintendo logo is displayed and the program is then started. If there is an error in the data, the screen flashes repeatedly.

For information on registering the Nintendo logo character data, refer to Appendix 3 of this manual, *Submission Requirements*.

**The conditions required for starting the user program are as follows.**

Starting Address	0x150 (default value)	The starting address can be freely set by writing a jump destination address at 0x102 and 0x103.
------------------	-----------------------	--

LCDC value	0x91
Stack value	0xFFFFE

## 2. RECOGNITION DATA FOR CGB (CGB ONLY) IN ROM-REGISTERED DATA

As with software created for DMG, software for CGB (including software only for CGB) must place data concerning items such as the name of the game and Game Pak specifications in the 80 bytes of the program area between 0x100 and 0x14F. In the system, a code indicating whether the software is for CGB should be set at address 0x143.

**Note** For an overall description of the ROM area shown below, please refer to Appendix 3, Submission Requirements.

Setting a value of 0x80 or 0xC0 at this address causes the system to recognize the software as being for CGB.

If 0x00 or any value less than 0x7F (existing DMG software) is set at this address, the software is recognized as non-CGB software and CGB functions (registers) are not available.

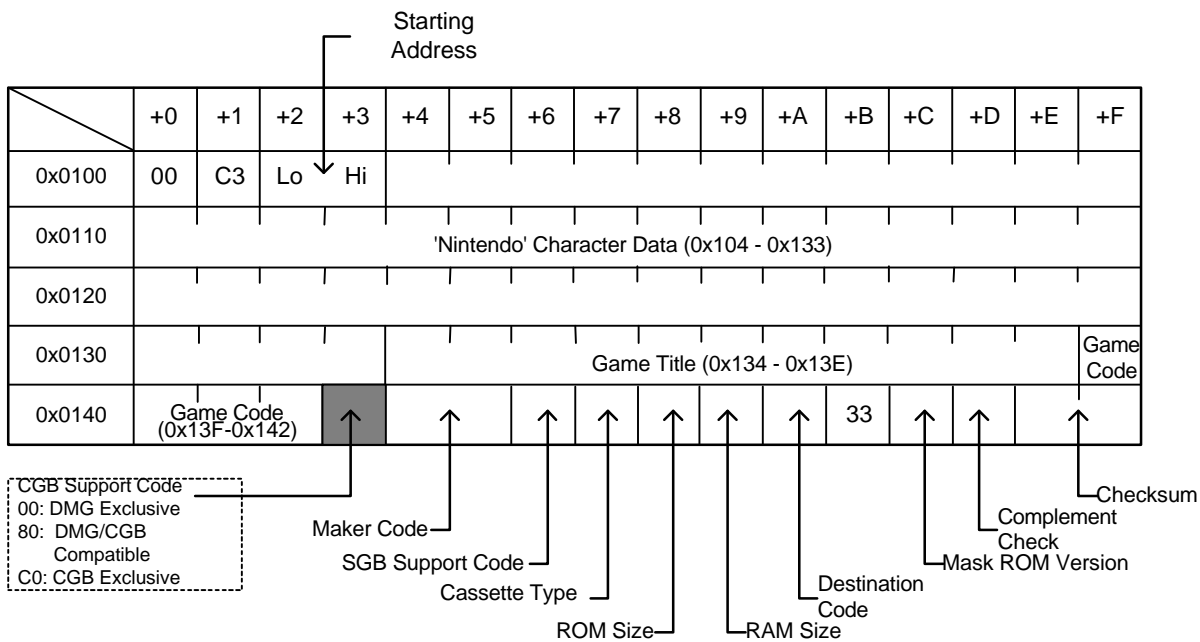

CGB/CGB Only: When operating on CGB, up to 56 colors can be displayed on a single screen.

Non-CGB: When operating on CGB, up to 10 colors can be displayed on a single screen.

**Note** Regardless of the type of game, the following fixed values should be stored at the following addresses.

- Address 0x100=0x00
- Address 0x101=0xC3
- Address 0x14B=0x33
- Addresses 0x104 – 0x133='Nintendo' character data

### 3. POWER-SAVING ROUTINES FOR THE MAIN PROGRAM

To minimize battery power consumption and extend battery life, inclusion of programs such as those shown below is recommended.

During waiting for vertical blanking, halt the CPU system clock to reduce power consumption by the CPU and ROM.

```

.*****
;
.*****
;
.*****
;
Main Routine
*****
*****

MAIN
CALL  CONT      :   Keypad input.
CALL  GAME      :   Game or other processing.

VBLK_WT
HALT                :   Halt the system clock.
                :   Return from HALT mode if an interrupt is generated.
                :   Wait for a vertical blanking interrupt.
NOP                :   Used to avoid bugs in the rare case that the instruction.
                :   after the HALT instruction is not executed.

LD      A, (VBLK_F)
AND     A
JR      Z, VBLK_WT :   Generate a V-blank interrupt?
XOR     A          :   Jump if a non-V-blank interrupt.
LD      (VBLK_F), A
JR      MAIN

.*****
;
.*****
;
.*****
;
Vertical Blanking Routine
*****
*****

VBLK
PUSH   AF
PUSH   BC
PUSH   DE
PUSH   HL

CALL   DMA

LD     A, 1          :   Set the V-blank completion flag.
LD     (VBLK_F), A

POP    HL
POP    DE
POP    BC
POP    AF
RETI

```

HALT instructions should not be executed while CGB horizontal blanking DMA is executed. (See Appendix 1, *Programming Cautions*.)

## 4. SOFTWARE CREATED EXCLUSIVELY FOR CGB

Because the shape of the Game Pak for CGB-only software is the same as that for DMG, CGB-only Game Paks also can be inserted in DMG. Therefore, a program that displays a message such as that shown below when a CGB-only Game Pak is mistakenly inserted in DMG should always be included in the software. The upper part of the message screen should display the official title of the game.

If the title is similar to that of other software (e.g., series software), a subtitle should also be displayed to distinguish the programs from one another.

For information on software methods of distinguishing game units, see Section 6 of this chapter, *Software Created for CGB: Example*.

### *Sample Message Display*

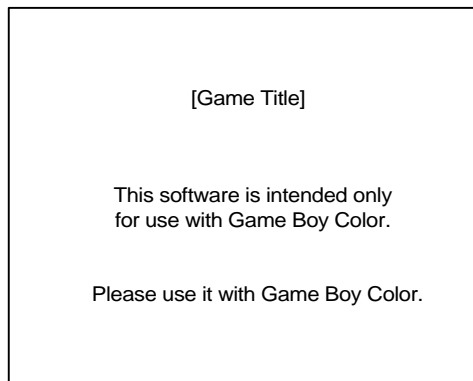

## 5. SOFTWARE CREATED TO OPERATE ON CGB

As is shown below, CGB and DMG differ slightly in their specifications and operation. When creating software to operate on CGB, please give appropriate consideration to these differences.

CGB	DMG
When objects with different x-coordinates overlap, the object with the lowest OBJ NO. is given display priority.	When objects with different x-coordinates overlap, the object with the smallest x-coordinate is given display priority.
In CGB mode, BG display CANNOT be turned off using bit 0 of the LCDC register (address 0xFF40).	BG display CAN be turned on and off using bit 0 of the LCDC register (address 0xFF40).
_____	When the value of register WX (address 0xFF4B) is 166, the window is partially displayed.
_____	When an instruction that register pair increment is used, if the value of the register pair is an address that specifies OAM (0xFE00-0xFE9F), OAM may be destroyed.

## 6. SOFTWARE CREATED TO OPERATE ON CGB: EXAMPLE

When creating software for CGB, a CGB support code is set in the ROM data area, and processing branches according to the hardware used internally by the program. For more information, see the flowchart in Part 1 of Section 6.3 of this chapter. Limiting the functions used, as shown below, allows the same processing to be used for different units without branching. For more information, see the flowchart in Part 2 of Section 6.3 of this chapter.

The following example describes how to create a program that operates on both CGB and DMG and allows display of 56 colors when running on CGB. Such means can be used to maintain compatibility with earlier hardware (DMG) while using CGB functions.

### 6.1 Program Specifications

- Only bank 0 is used as the character data area.
- Only the bits that specify the color palette (bits 0-2 of bank 1) are used for BG attributes.

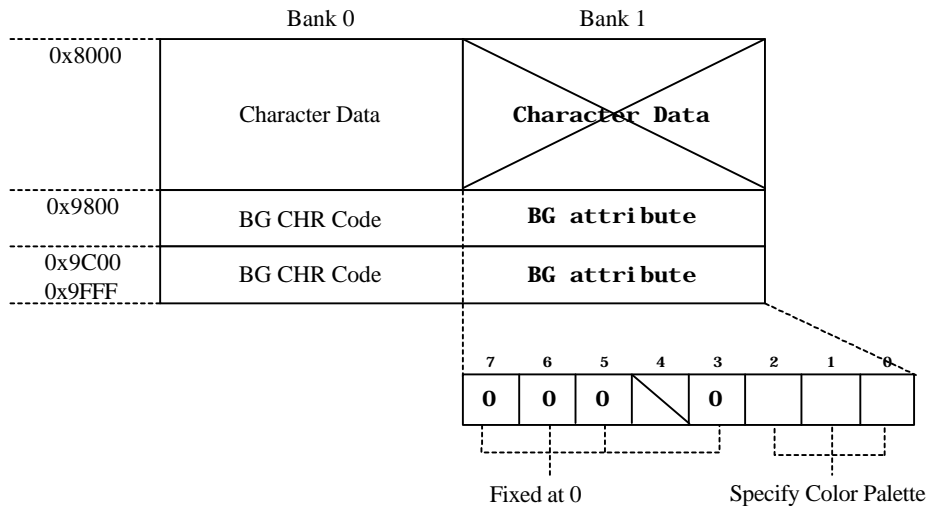

- Both the color palette and DMG-mode palette are set as attribute flags in the OAM register.

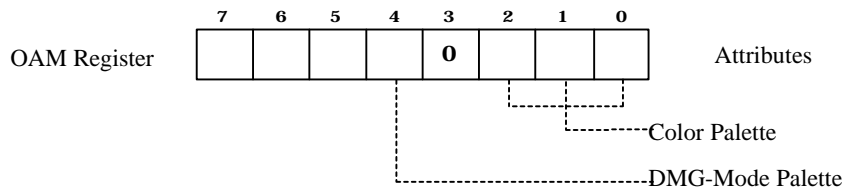

- None of the other expanded CGB functions are used.

## **6.2 CGB Recognition Method**

Immediately after program startup, the initial value of the accumulator (register A) is read to determine whether the hardware on which the program is operating is a DMG (SGB), MGB/MGL (SGB2) , or CGB.

0x01 → DMG (SGB)  
0xFF → MGB/MGL (SGB2)  
0x11 → CGB



6.3 Flowcharts

1) Branched Processing for CGB and DMG/MGB/MGL

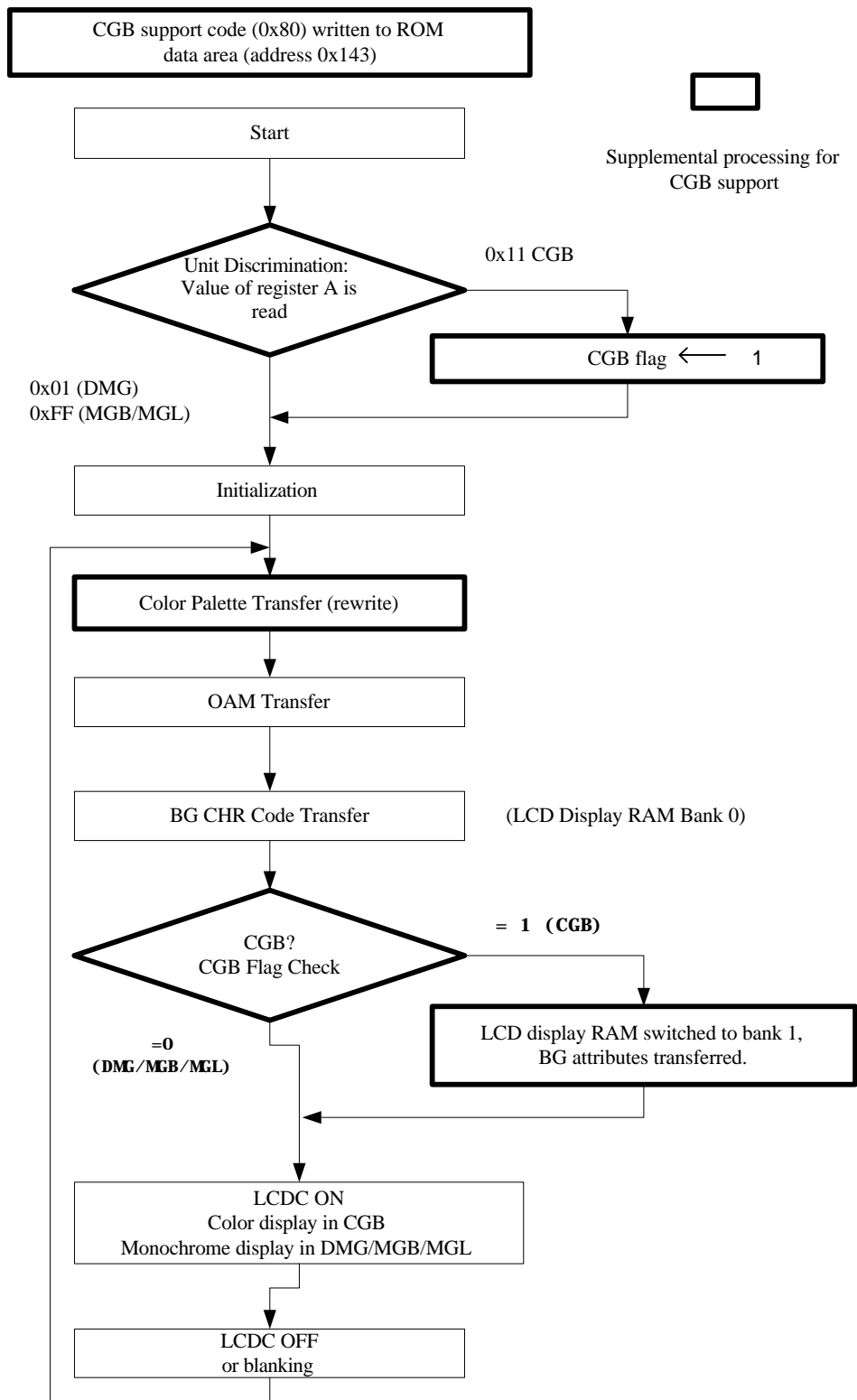

2) Uniform processing for CGB and DMG/MGB/MGL

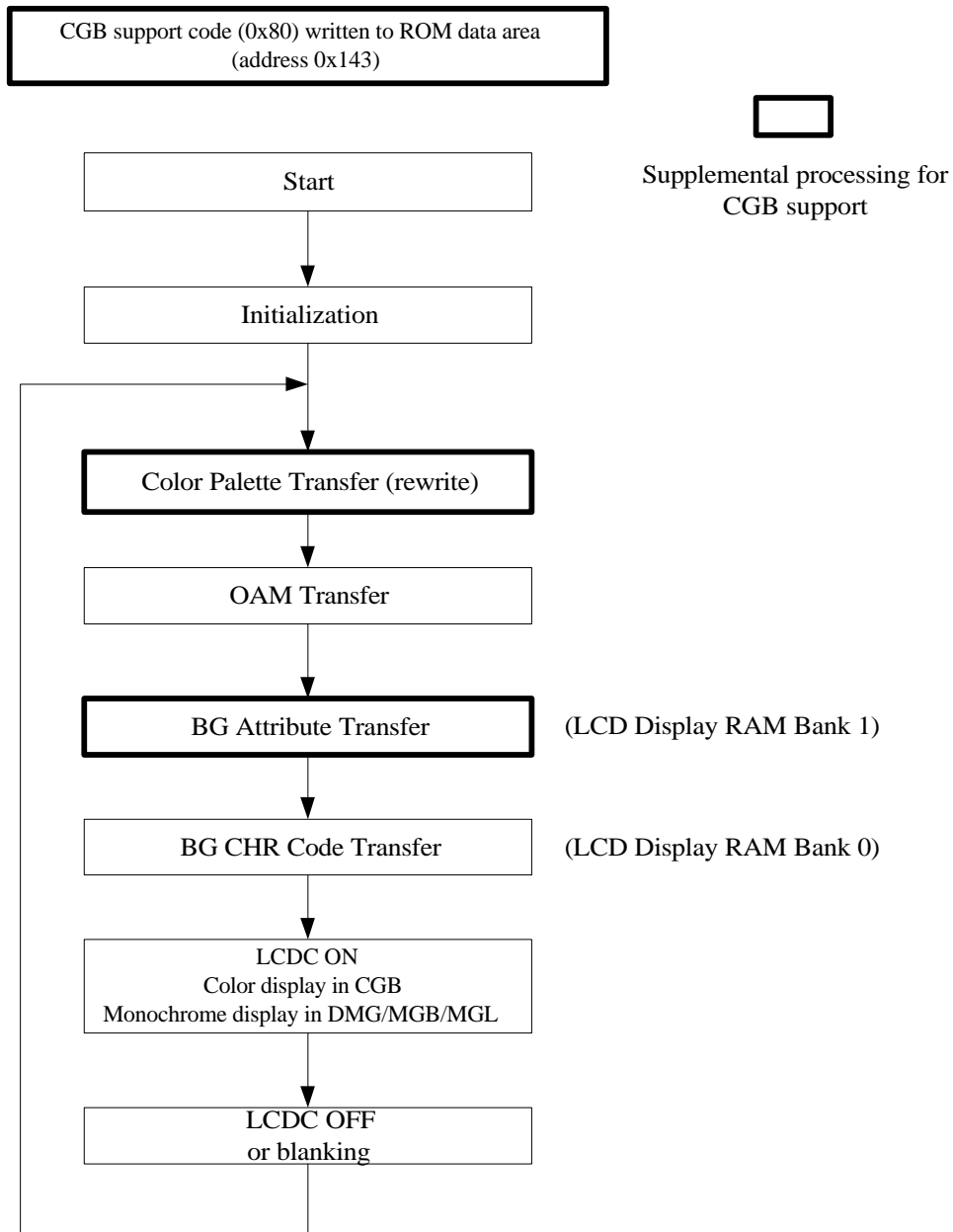

**Note** *The BG attributes should always be transferred before the BG character code. Even if only the BG attributes are changed, always transfer the character code from that same address.*

<b>Chapter 6: The Super Game Boy System .....</b>	<b>124</b>
<b>1. Overview .....</b>	<b>124</b>
1.1 What is Super Game Boy? .....	124
1.2 Block Diagram .....	125
1.3 Functions .....	126
1.4 System Program .....	126
<b>2. Sending Commands and Data to SUPER NES .....</b>	<b>127</b>
2.1 System Commands .....	127
2.2 Data Transfer Using an Image Signal .....	131
<b>3. System Commands .....</b>	<b>132</b>
3.1 System Command Summary .....	132
3.2 System Command Details .....	133
3.3 Cautions Regarding Sending Commands .....	167
3.4 Sound Flag Summary .....	167
<b>4. Miscellaneous .....</b>	<b>173</b>
4.1 Reading Input from Multiple Controllers .....	173
4.2 Recognizing SGB .....	174
4.3 SGB Register Summary .....	176
4.4 Flowchart of Initial Settings Routine .....	177
<b>5. Programming Cautions .....</b>	<b>178</b>
5.1 ROM Registration Data .....	178
5.2 Initial Data .....	178
5.3 SOU_TRN default data .....	179

## **CHAPTER 6: THE SUPER GAME BOY SYSTEM**

### **1. OVERVIEW**

#### **1.1 What is Super Game Boy (SGB)?**

SGB is a device that enables Game Boy software to be enjoyed on a TV screen. Game Boy software can be plugged into the SGB, which operates on the Super Nintendo Entertainment System (Super NES).

SGB consists of the basic Game Boy circuitry, and components such as an Intercommunication Device (ICD, with built-in SGB RAM), the system program, and a CIC.

Basic SGB operation involves conversion by the ICD of 2-bit, 4 grayscale image signals generated by the SGB CPU to SUPER NES character data and storage of these data in SGB RAM. The system program subsequently transfers this data by DMA to SUPER NES WRAM and then to VRAM. The above operations are performed repeatedly to display the Game Boy screen on a TV screen.

Unmodified sound output from the SGB CPU is linked to the SUPER NES sound mixing circuit and is output from the speaker on the TV.

These operations are controlled by the SGB system program and therefore require no special consideration when programming for Game Boy.

Game Boy software not specifically created for SGB provides 4 colors in 4 grayscales. These colors are selected from several color patterns provided in the system program. Programming using the system commands described later allows a game to be represented using 4 palettes of 4 colors each per screen and SUPER NES functions such as SUPER NES sound.

Super Game Boy comes in 2 models: the 1994 model, which has no communication connector, and the 1998 model, which is equipped with a communication connector.

This manual uses the term SGB2 when discussing points that concern only the 1998 model. Descriptions that use the term Super Game Boy or SGB refer to both Super Game Boy models. SGB2 allows game representations that use SHVC functions for communication play. (SGB2 has not been released in the U.S. market.)

1.2 Block Diagram

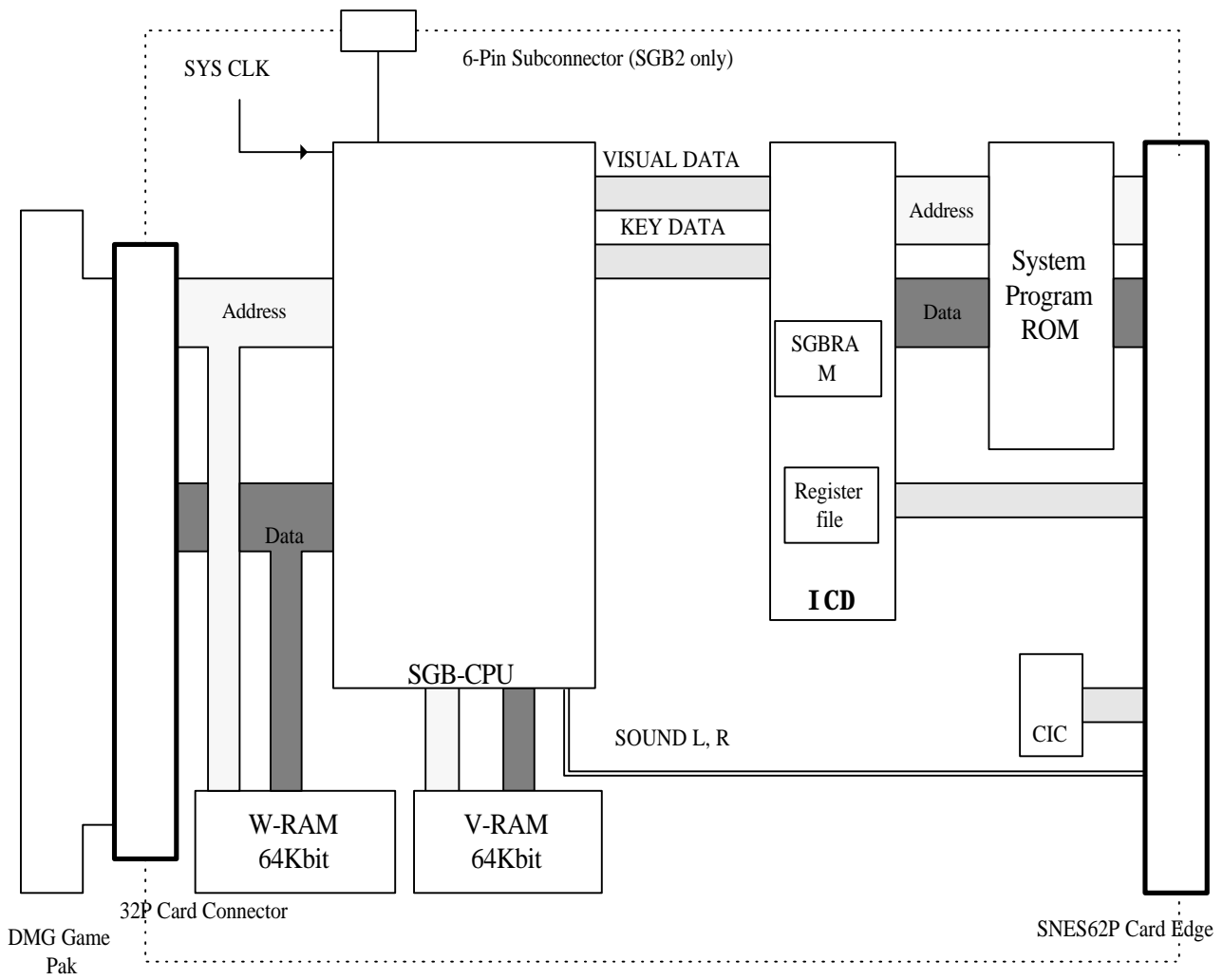

### **1.3 Functions**

The types of representations indicated below can be implemented using SUPER NES functions invoked by sending system commands.

For more information, please see Section 3 in this chapter, *System Commands*.

#### ***Image Functions***

- Up to 4 palettes of 4 colors each can be represented on a single screen.
- Multiple areas can be specified for each screen, and separate color palette attributes can be specified for each area.
- Color palette attributes can be specified separately for each character (8 x 8 bits).

#### ***Sound Functions***

- The rich variety of sound effects included in the system program can be generated by the SUPER NES audio processing unit (APU).
- The sound generator included in the system program can be used by transferring music data.

#### ***Controller Functions***

- Data from multiple SUPER NES controllers can be read, providing for multiplayer games that can accommodate between 2 and 4 players.

#### ***Miscellaneous***

- SUPER NES program data can be transferred.

### **1.4 System Program**

The system program can provide the following features.

- On the T.V. screen, the system program displays the space outside the game screen (picture frame).

The picture frame has the following features.

- The frame can be selected from among 9 pre-loaded frames.
- A mode in which an image created by the game producer is transferred and displayed as the frame.
- A drawing mode that allows the user to create the frame.

Features of the color palette selection screen are as follows.

- Palettes can be selected from among 32 pre-loaded palettes.
- A mode that allows colors to be set from DMG in DMG games.

A mode is available that allows the user to arrange the colors on a palette.

A screen is provided for changing the key configuration of the controller.

- If the commands described in Section 3.2 in this chapter, *System Command Details*, are sent to the register file, Super NES functions, such as those described in Section 1.3, *Functions*, can be used by having the system program read these commands.

## 2. SENDING COMMANDS AND DATA TO SUPER NES

The following 2 methods can be used to send data from a DMG program to Super NES.

Send data to the register file using P14 and P15. The size of the register file is 128 bits; this is referred to as 1 packet.

Send data to SGB RAM using an image signal.

**NOTE** *Data transfers from the register file and SGB RAM to SUPER NES are performed by the system program.*

### 2.1 System Commands

Using the register file to transmit system commands allows the various SUPER NES functions described below to be used in games.

The system program receives the commands and performs the specified processing.

- Data Format of System Commands

#### 1) Data Transmission Methods

Using 2 bits in SGB (P14 and P15 of SGB CPU), data is sent to the register file by serial transmission.

The system program reads the contents written to the register file.

1. Start write

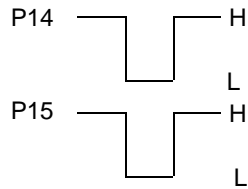

A LOW pulse is output to both P14 and P15. This is required for transmission of each packet (128 bits).

2. Write 0

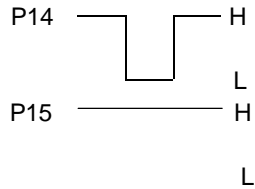

P15 is fixed at HIGH, and a LOW pulse is output to P14.

3. Write 1

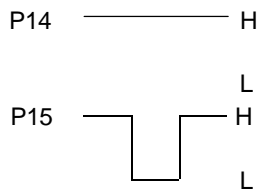

P14 is fixed at HIGH, and a LOW pulse is output to P15.

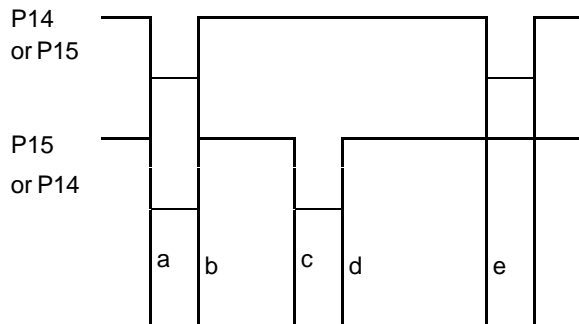

Pulse Width	
a, c, e	5 $\mu$ s (min)
b, d	15 $\mu$ s (min)



2) Write Example

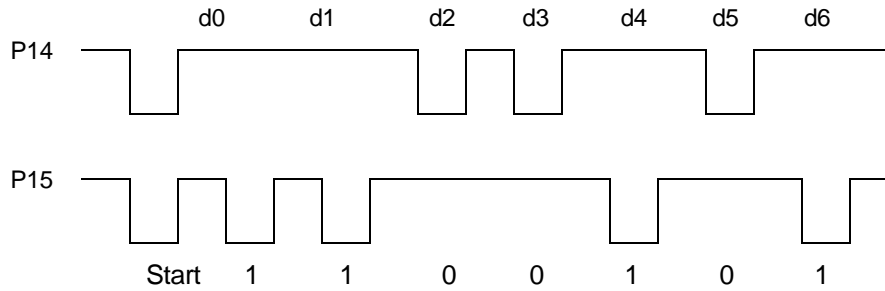

3) Format of Data Transmitted to Register File

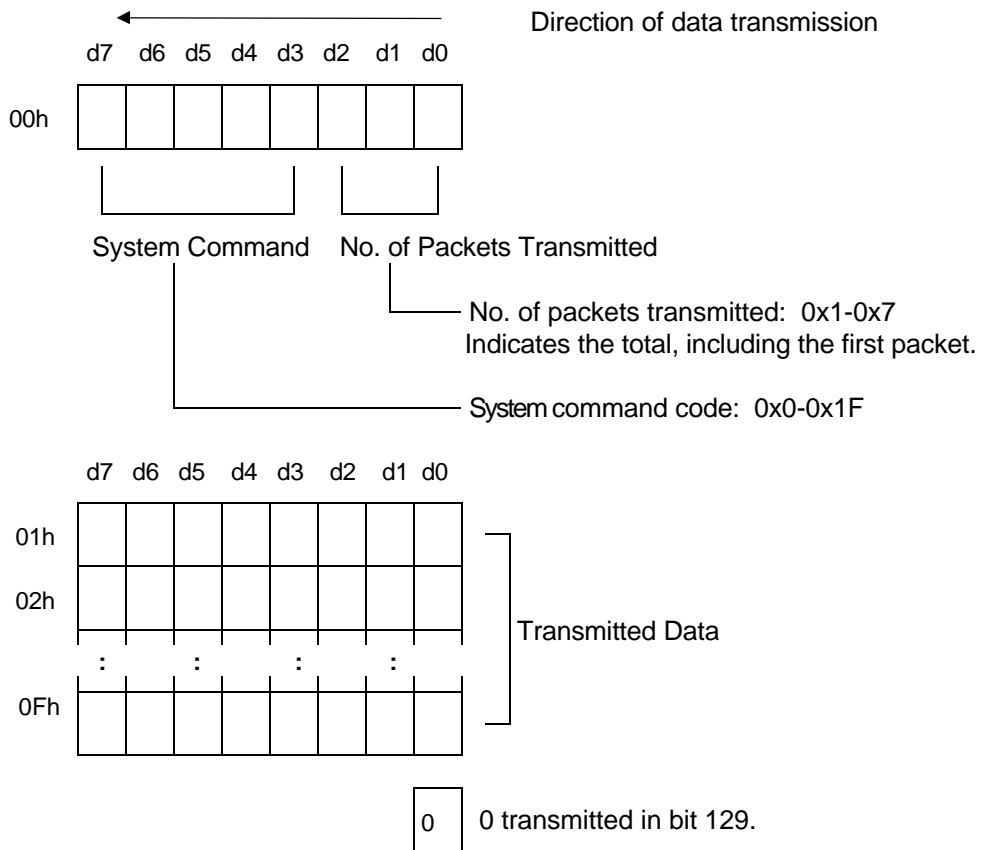

If 2 or more packets are used for one system command, bits 0x00-0xF of the second packet onward are used for data.

Transmission Procedure

1. Start of write
2. Data transmission (example)

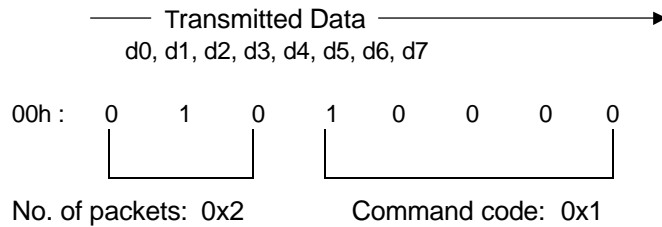

0x01: data  
 0x02: data  
 : :  
 : :  
 0xF: data

3. Transmission of 0 in bit 129

Bit 129: 0

4. Start of write
5. Data transmission: second packet

0x00: data  
 0x01: data  
 : :  
 : :  
 0xF: data

1. Transmission of 0 in bit 129

Bit 129: 0

4) Transmission Interval

The interval between completion of transmission of one packet (128 bits + 1 bit) and transmission of the next packet is set at approximately 60 msec (4 frames).

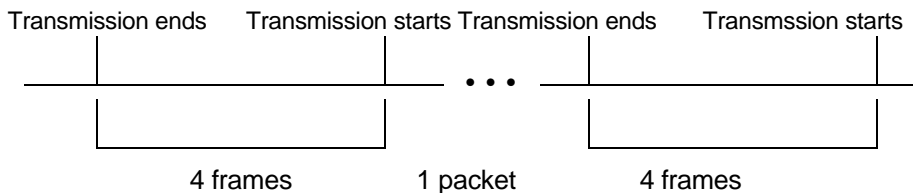

5) Transmission Bit 129

The data in bit 129 marks the end of one packet, so it should always be transmitted.

## 2.2 Data Transfer Using an Image Signal

Data and programs stored in a cartridge can be transferred using the image signal transmission path (LD0, LD1).

Character data stored in DMG VRAM and displayed are then stored in SGB RAM. The system program usually transfers these data to SUPER NES VRAM as character data. However, when a specific command is received, the data is handled as data for command processing.

The displayed image signal is handled directly as data, so be careful to ensure that the OBJ display and window are set to OFF, the correct values are set for the DMB color palette, and the BG to be displayed is correctly transferred.

When data is transferred they are displayed to the screen, so the system command MASK\_EN must be used to mask the screen.

For more information, see Section 3.2 in this chapter, *System Command Details*.

<b>Note</b>	<b>Commands that transfer data using image signals are indicated by the heading, Data Transfer Using VRAM.</b>
-------------	--

### 3. SYSTEM COMMANDS

#### 3.1 System Command Summary

Command	Command Code	Command	Command Code
PALO1	00	DATA_TRN	10
PAL23	01	MLT_REQ	11
PAL03	02	JUMP	12
PAL12	03	CHR_TRN	13
ATTR_BLK	04	PCT_TRN	14
ATTR_LIN	05	ATTR_TRN	15
ATTR_DIV	06	ATTR_SET	16
ATTR_CHR	07	MASK_EN	17
SOUND	08	PAL_PRI	19
SOU_TRN	09	Use prohibited	0D
PAL_SET	0A	Use prohibited	18
PAL_TRN	0B		
ATRC_EN	0C		
ICON_EN	0E		
DATA_SND	0F		

### 3.2 System Command Details

Please refer to the following map in the discussion of coordinate settings and color palette area specifications in the description of the system command functions.

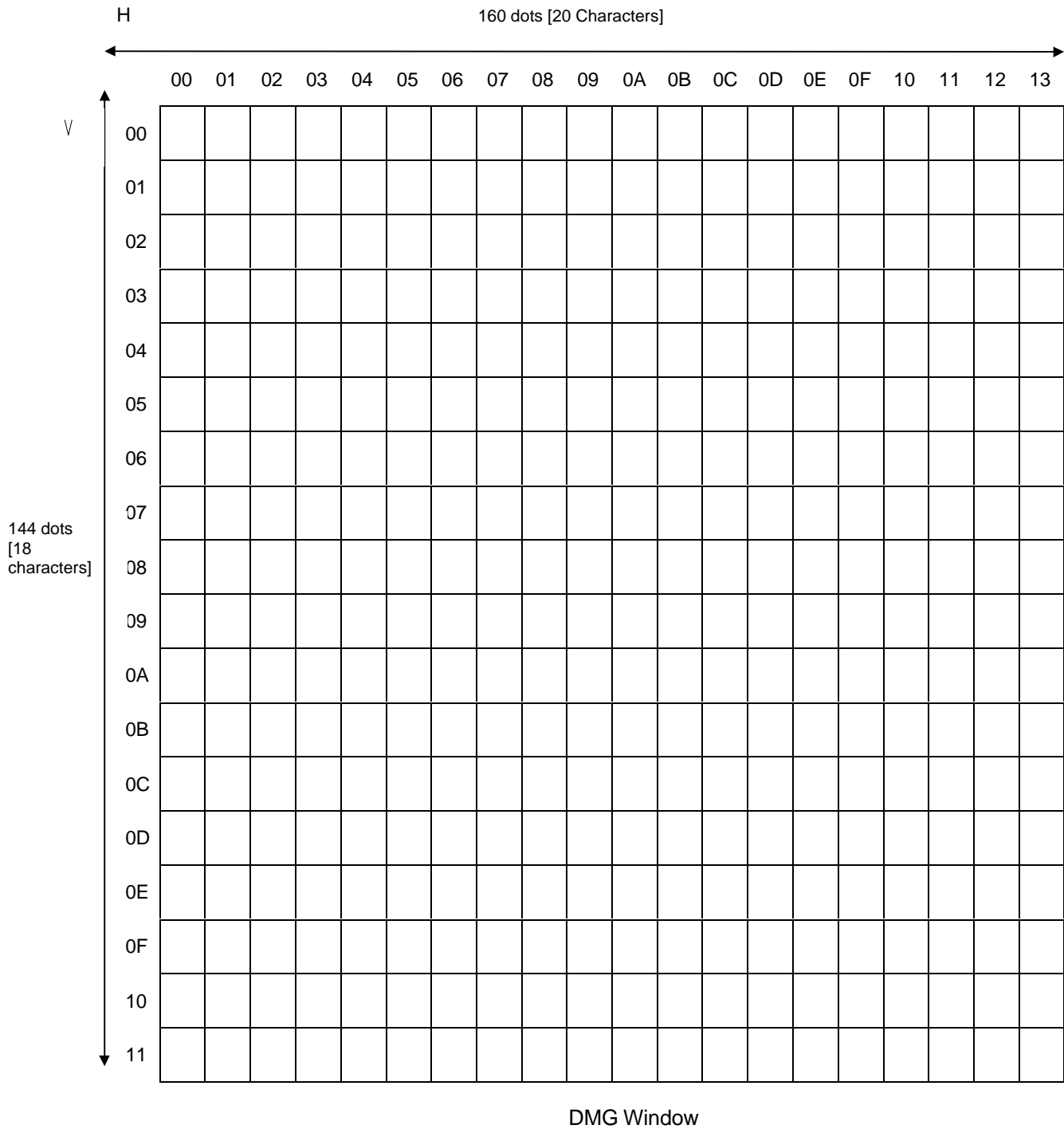

## Setting the Color Palettes and Attributes

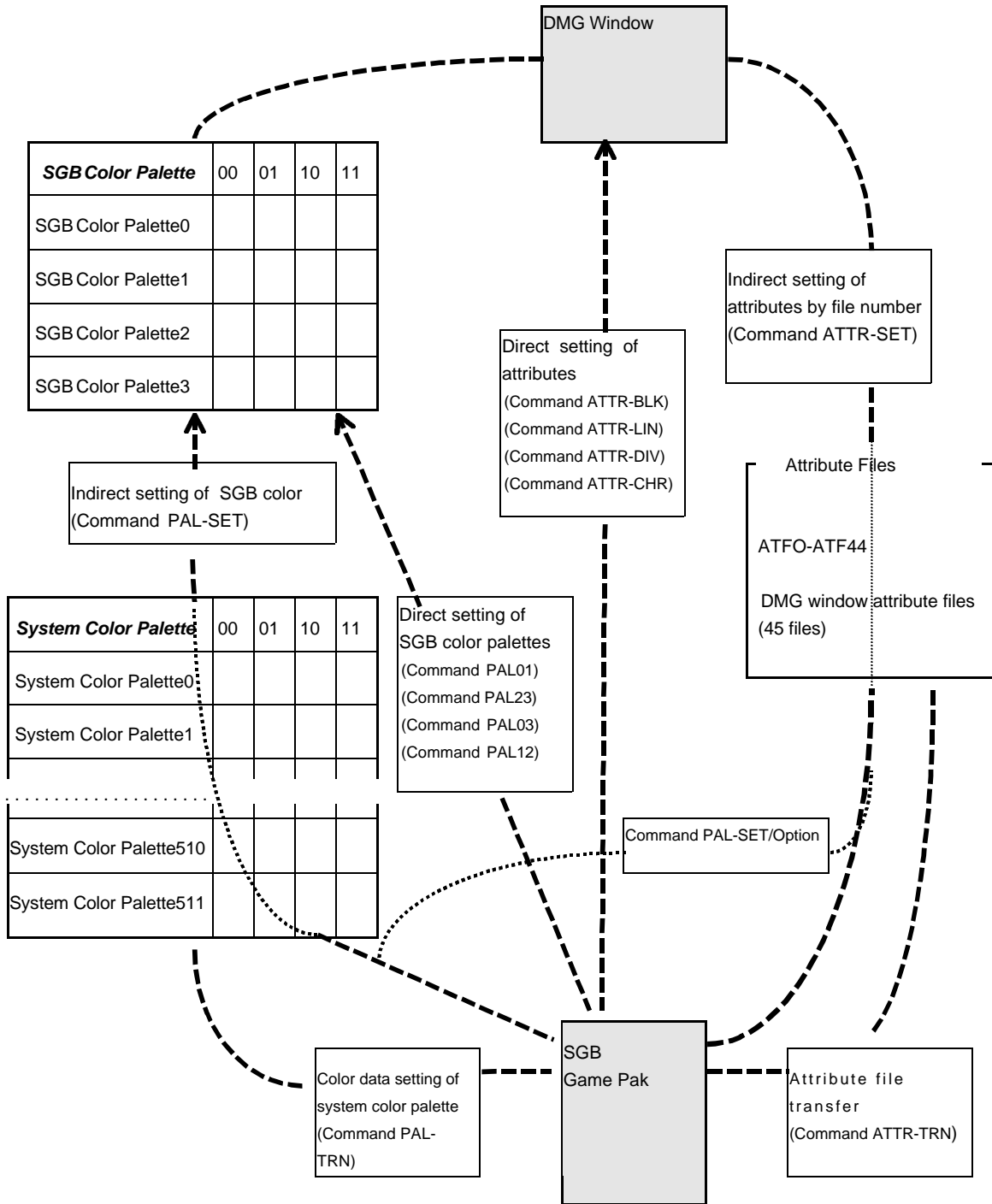

**Note** *Bit 00 of SGB color palettes 0 – 3 have the same color. The color setting in effect for this bit is the most recent setting.*

### DMG Color Palettes and SGB Color Palettes

With DMG screen data representations, colors in SGB are converted from the grayscale data registered in the DMG color palettes, rather than being converted from the bit data for the character.

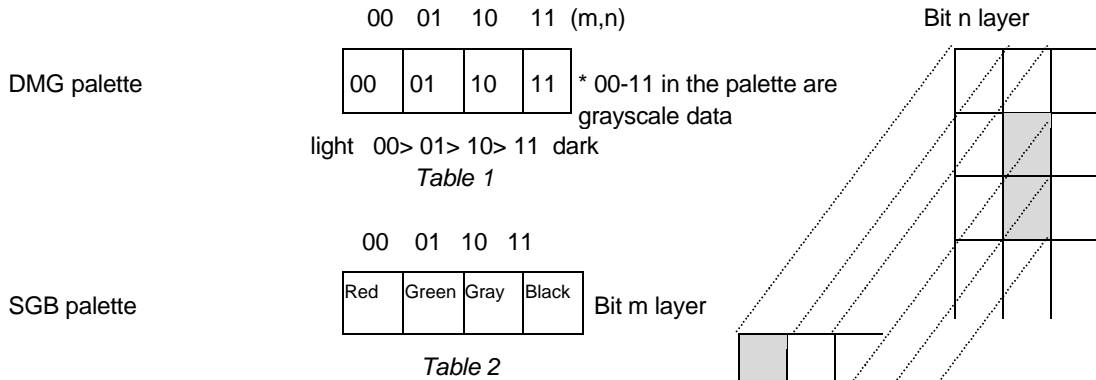

Example: When the grayscale data shown in Table 1 are specified for the DMG palette, the character represented on the DMG LCD is as shown in the DMG character image figure below and to the left. Accordingly, when the color data shown in Table 2 are specified for the SGB palette, the character image represented on SUPER NES is as shown in the SGB character image figure below and to the right.

DMG Character Image

10	00	
00	01	
00	11	

00-11: grayscale data

However, if bit 11 of the DMG palette is set to grayscale 00, the portion of the DMG character image is displayed with a 00 grayscale, and the portion of the SGB character image is displayed as red rather than black.

SGB character image

Gray	Red	
Red	Green	
Red	Black	

Thus, in this case, when character data display using all of the colors on the SGB palette is desired, a separate grayscale palette (DMG palette) for SGB must be provided, DMG and SGB must be distinguished, and the program must be made to branch accordingly.  
(See Section 4.2, *Recognizing SGB*.)

When representing DMG grayscale on SGB, the image can be faithfully represented if 00 of the SGB palette is set to a light color and 11 to a dark color.

**Command: PAL01 (Code: 0x00)**

Function: Sets the color data of SGB color palettes 0 and 1.

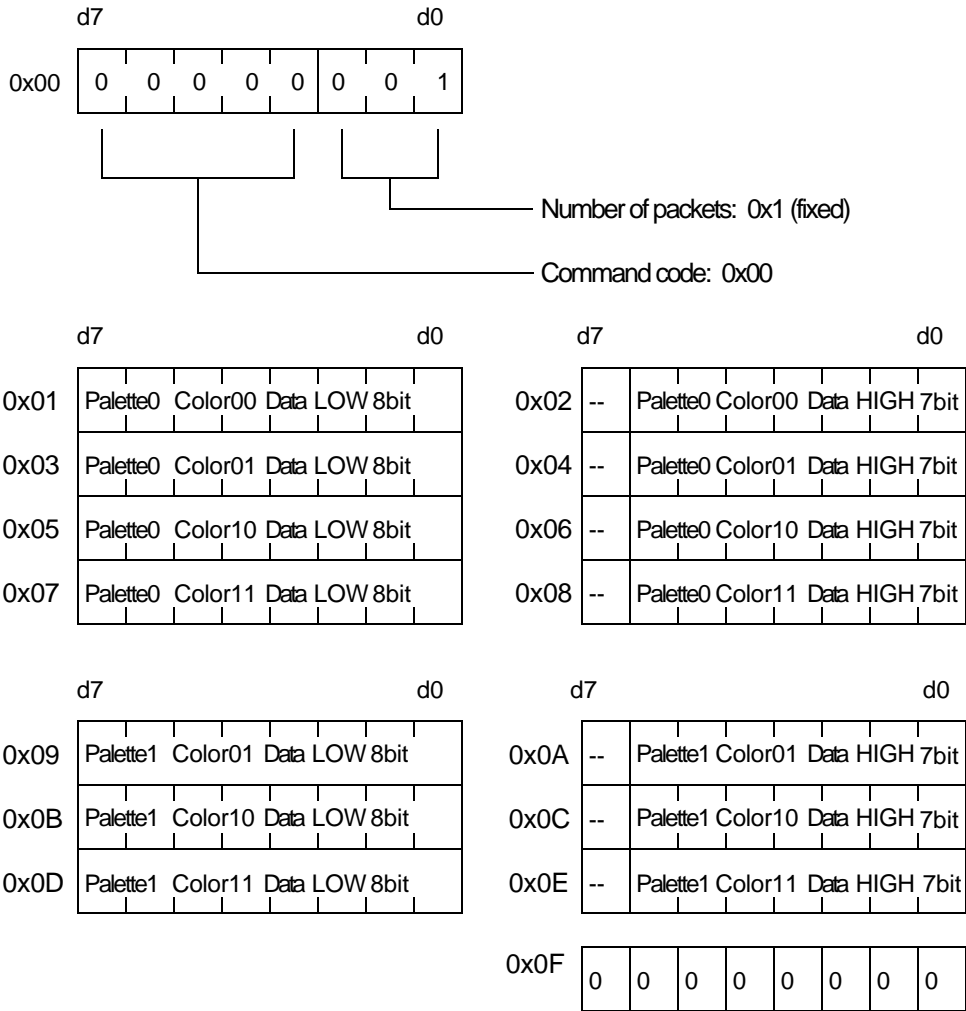



**Command: PAL23 (Code: 0x01)**

Function: Sets the color data for SGB color palettes 2 and 3.

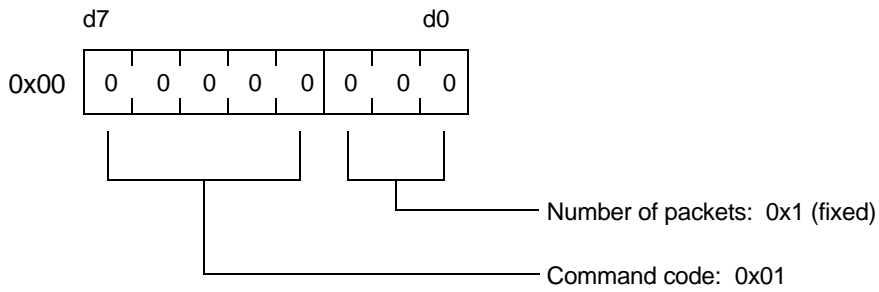

d7									d0	d7									d0
0x01	Palette2	Color00	Data	LOW	8bit	0x02	--	Palette2	Color00	Data	HIGH	7bit							
0x03	Palette2	Color01	Data	LOW	8bit	0x04	--	Palette2	Color01	Data	HIGH	7bit							
0x05	Palette2	Color10	Data	LOW	8bit	0x06	--	Palette2	Color10	Data	HIGH	7bit							
0x07	Palette2	Color11	Data	LOW	8bit	0x08	--	Palette2	Color11	Data	HIGH	7bit							
d7									d0	d7									d0
0x09	Palette3	Color01	Data	LOW	8bit	0x0A	--	Palette3	Color01	Data	HIGH	7bit							
0x0B	Palette3	Color10	Data	LOW	8bit	0x0C	--	Palette3	Color10	Data	HIGH	7bit							
0x0D	Palette3	Color11	Data	LOW	8bit	0x0E	--	Palette3	Color11	Data	HIGH	7bit							
0x0F	0	0	0	0	0	0	0	0											

**Command: PAL03 (Code: 0x02)**

Function: Sets the color data for SGB color palettes 0 and 3.

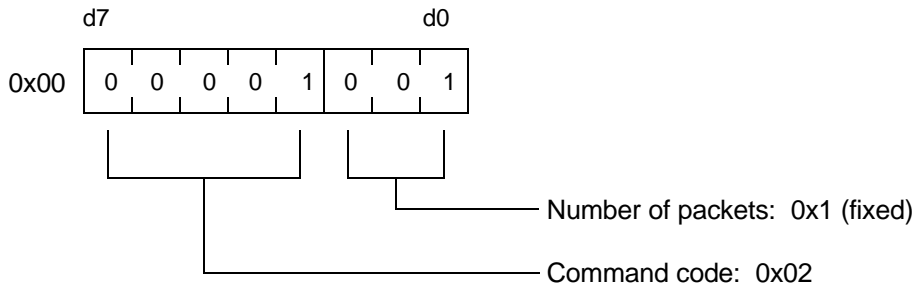

	d7	d6	d5	d4	d3	d2	d1	d0
0x01	Palette0	Color00	Data	LOW	8bit			
0x03	Palette0	Color01	Data	LOW	8bit			
0x05	Palette0	Color10	Data	LOW	8bit			
0x07	Palette0	Color11	Data	LOW	8bit			

	d7	d6	d5	d4	d3	d2	d1	d0
0x02	--	Palette0	Color00	Data	HIGH	7bit		
0x04	--	Palette0	Color01	Data	HIGH	7bit		
0x06	--	Palette0	Color10	Data	HIGH	7bit		
0x08	--	Palette0	Color11	Data	HIGH	7bit		

	d7	d6	d5	d4	d3	d2	d1	d0
0x09	Palette3	Color01	Data	LOW	8bit			
0x0B	Palette3	Color10	Data	LOW	8bit			
0x0D	Palette3	Color11	Data	LOW	8bit			

	d7	d6	d5	d4	d3	d2	d1	d0
0x0A	--	Palette3	Color01	Data	HIGH	7bit		
0x0C	--	Palette3	Color10	Data	HIGH	7bit		
0x0E	--	Palette3	Color11	Data	HIGH	7bit		

0x0F	0	0	0	0	0	0	0	0
------	---	---	---	---	---	---	---	---

**Command: PAL12 Code: 0x03**

Function: Sets the color data for SGB color palettes 1 and 2.

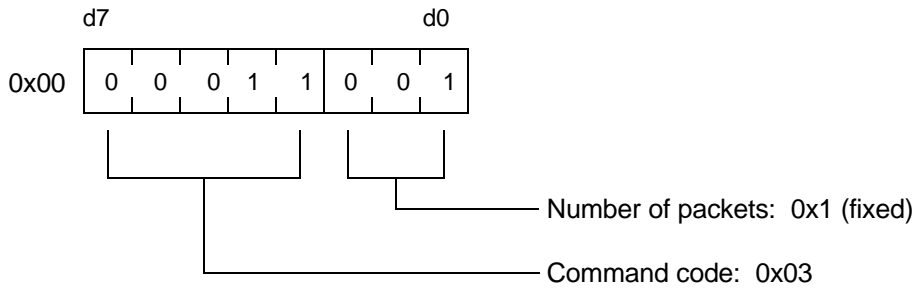

	d7									d0
0x01	Palette1	Color00	Data	LOW	8bit					
0x03	Palette1	Color01	Data	LOW	8bit					
0x05	Palette1	Color10	Data	LOW	8bit					
0x07	Palette1	Color11	Data	LOW	8bit					
	d7									d0
0x02	--	Palette1	Color00	Data	HIGH	7bit				
0x04	--	Palette1	Color01	Data	HIGH	7bit				
0x06	--	Palette1	Color10	Data	HIGH	7bit				
0x08	--	Palette1	Color11	Data	HIGH	7bit				
	d7									d0
0x09	Palette2	Color01	Data	LOW	8bit					
0x0B	Palette2	Color10	Data	LOW	8bit					
0x0D	Palette2	Color11	Data	LOW	8bit					
	d7									d0
0x0A	--	Palette2	Color01	Data	HIGH	7bit				
0x0C	--	Palette2	Color10	Data	HIGH	7bit				
0x0E	--	Palette2	Color11	Data	HIGH	7bit				
0x0F	0	0	0	0	0	0	0	0	0	0

**Command Code: ATTR\_BLK (Code: 0x04)**

Function: Applies the specified color palette attributes to areas inside and outside the square.

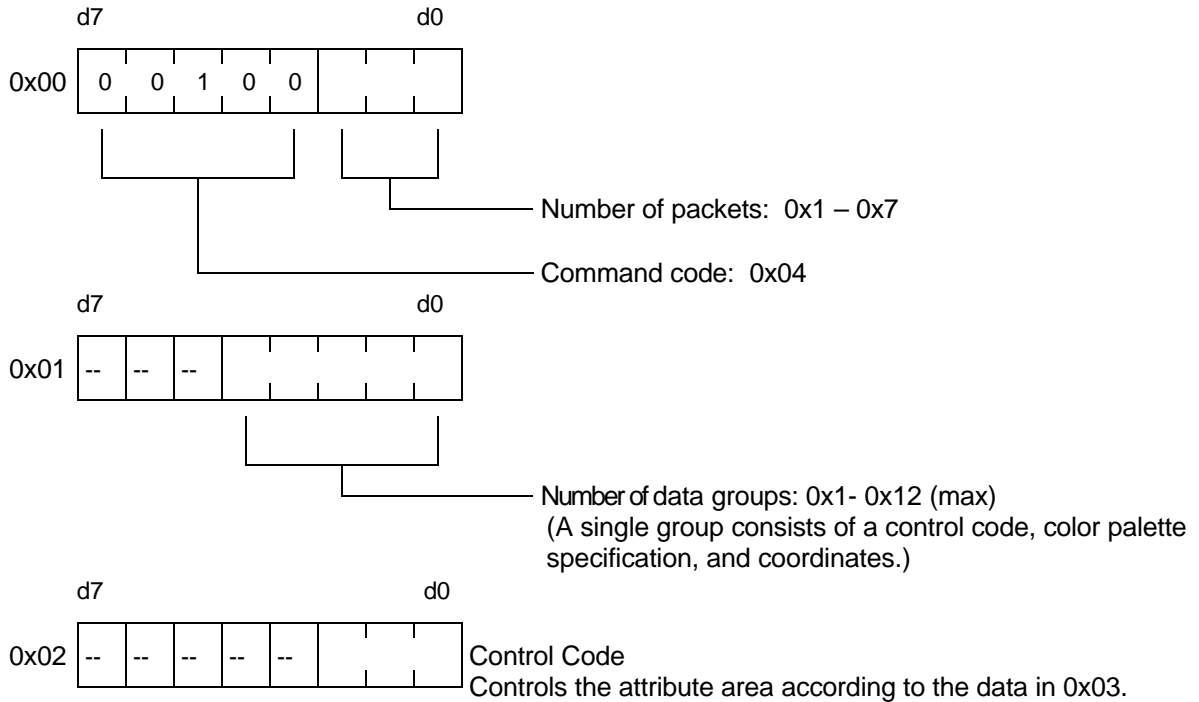

Control Codes

000	No control occurs.
001	Applies the attributes specified by d1 and d0 of 0x03 only to the area within the square (including the CHR border).
010	Applies the color palette attributes specified by d3 and d2 of 0x03 only on the square CHR border.
011	Applies the color palette attributes specified by d1 and d0 of 0x03 only to the area within the square, and applies the color palette attributes specified by d3 and d2 of 0x03 only to the border of the square.
100	Applies the attributes specified by d5 and d4 of 0x03 only to the area outside the square (including the CHR border).
101	Applies the color palette attributes specified by d1 and d0 of 0x03 to the area within the square, and applies the color palette attributes specified by d5 and d4 of 0x03 to the area outside of the CHR border. (CHR border is unchanged.)
110	Applies the color palette attributes specified by d5 and d4 of 0x03 only to the area outside of the square, and applies the color palette attributes specified by d3 and d2 of 0x03 to the CHR border .
111	Applies the specified color palette attributes to the area inside the square, to the CHR border line, and to the area outside the CHR border .

The color palette attributes of areas not specified are not changed.

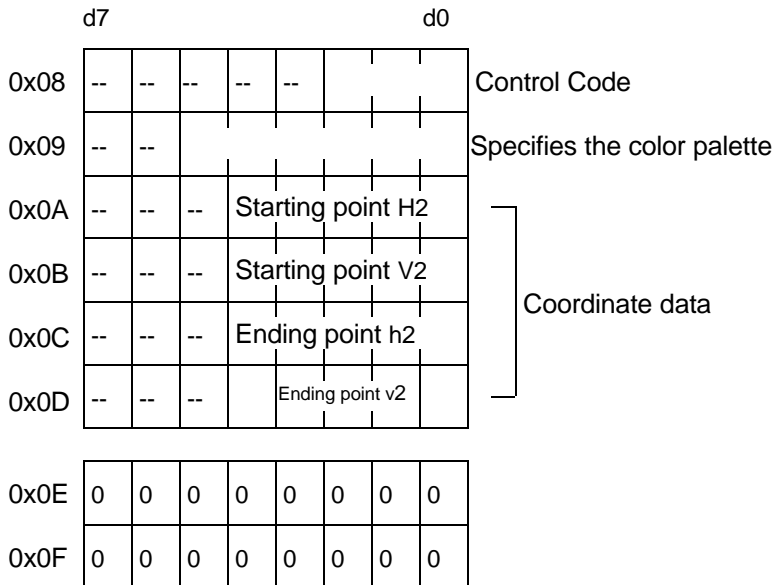
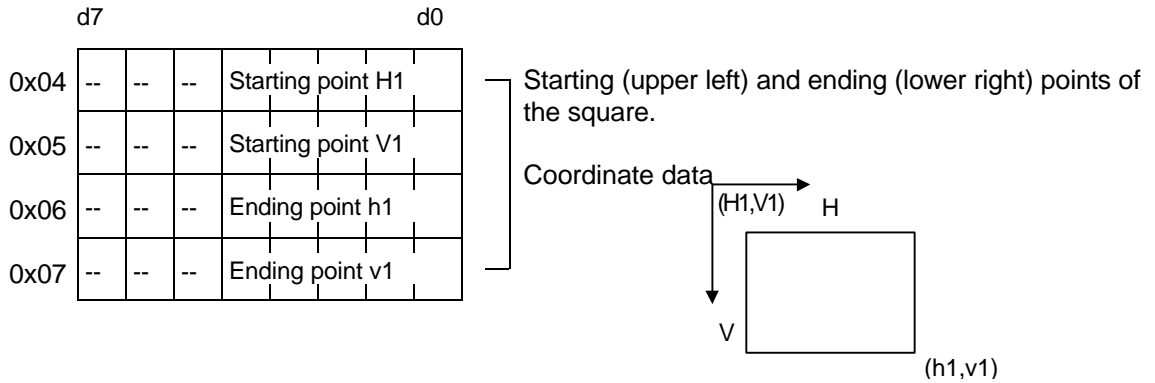
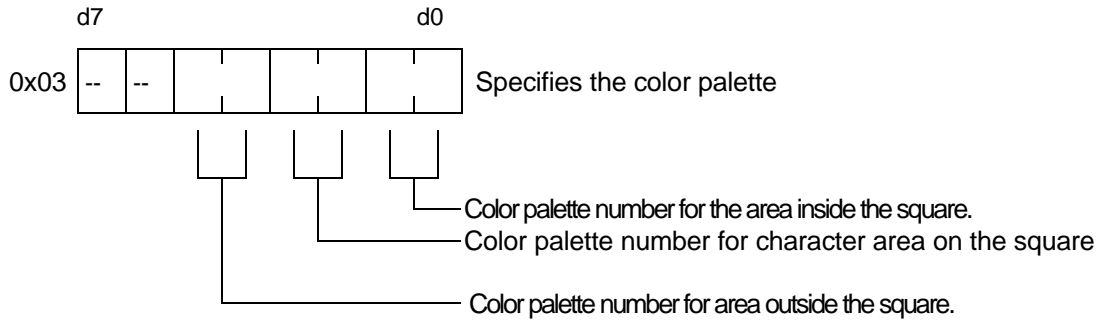

**Note** *If the number of packets is 1, 0x00 is written to 0x0E and 0x0F. If the number of packets exceeds 1, the control code and color palette specification code of the next data item are written to 0x0E and 0x0F, respectively.*



Please note that when ATTR\_BLK, ATTR\_LIN, ATTR\_DIV, or ATTR\_CHR are used, the data that is sent are valid even if MASK\_EN (freezes screen immediately before masking) is selected. When using MASK\_EN before these commands, use 0x10 or 0x11 as the argument. If 0x01 is used as the MASK\_EN argument, ATTR\_TRN and ATTR\_SET should be used.

**Command: ATTR\_LIN (Code: 0x05)**

Function: Applies the specified color palette attribute to a coordinate line.

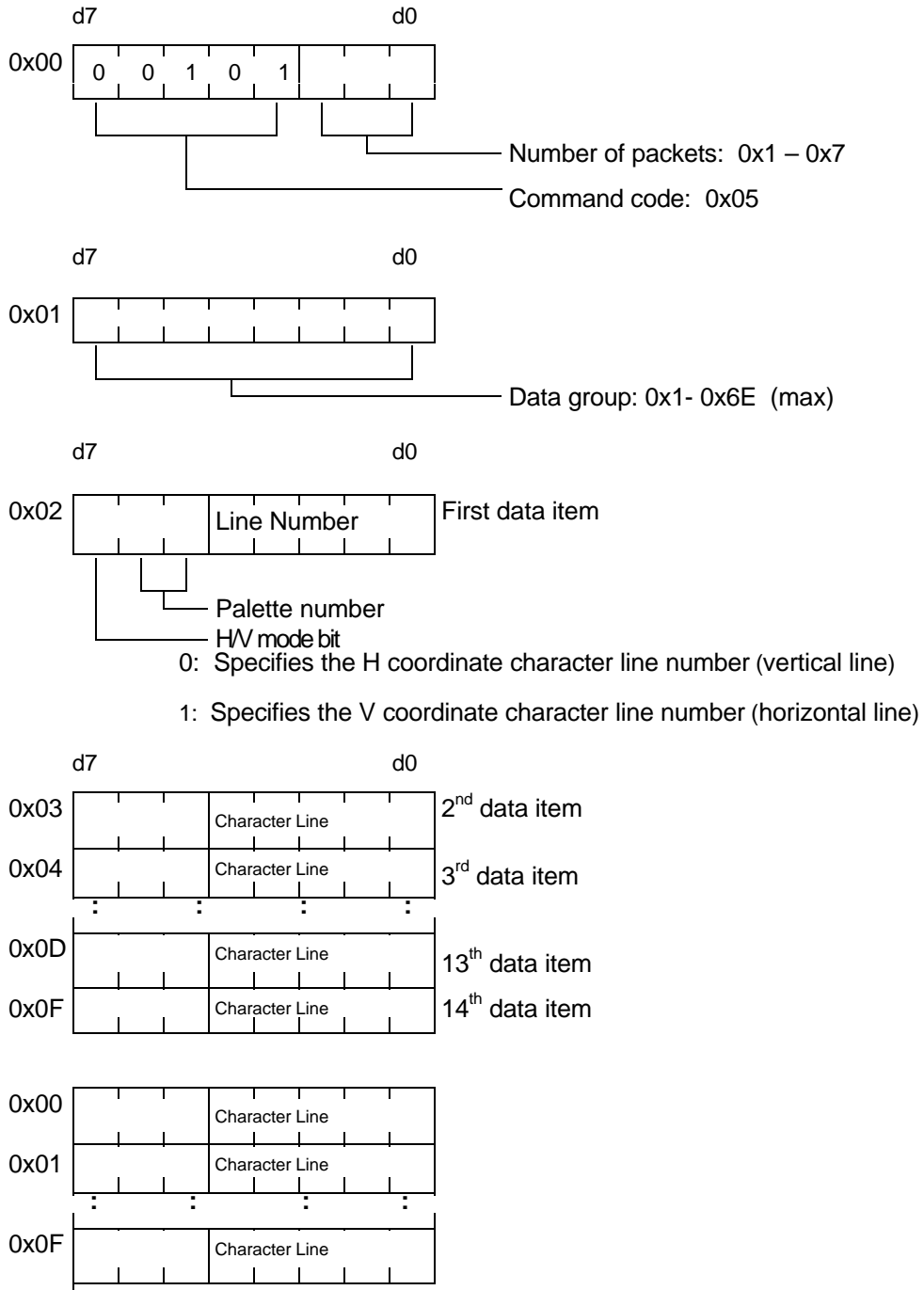

\* See the note on ATTR\_BLK.



**Example**

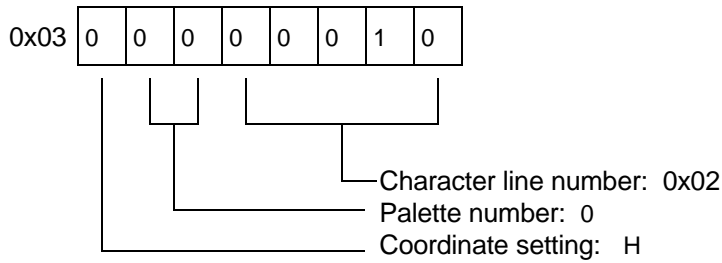
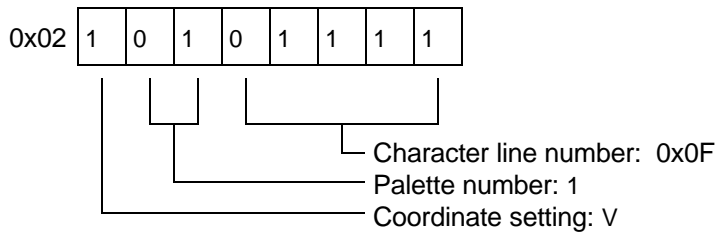
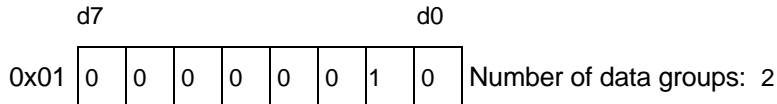
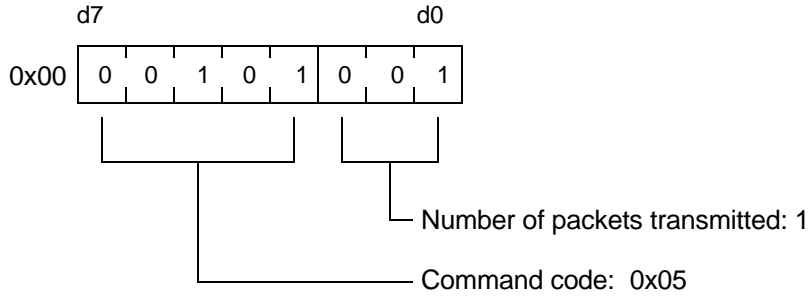

Applies the Palette 0 attribute to this line.

→H 02

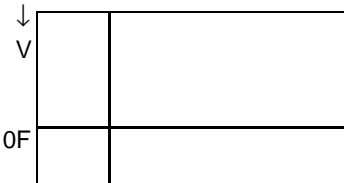

Applies the Palette 1 attribute to this line.

\* The color of intersection of the two lines is decided by the last line color.

**Command: ATTR\_DIV (Code: 0x06)**

Function: Divides the color palette attributes of the screen by the specified coordinates.

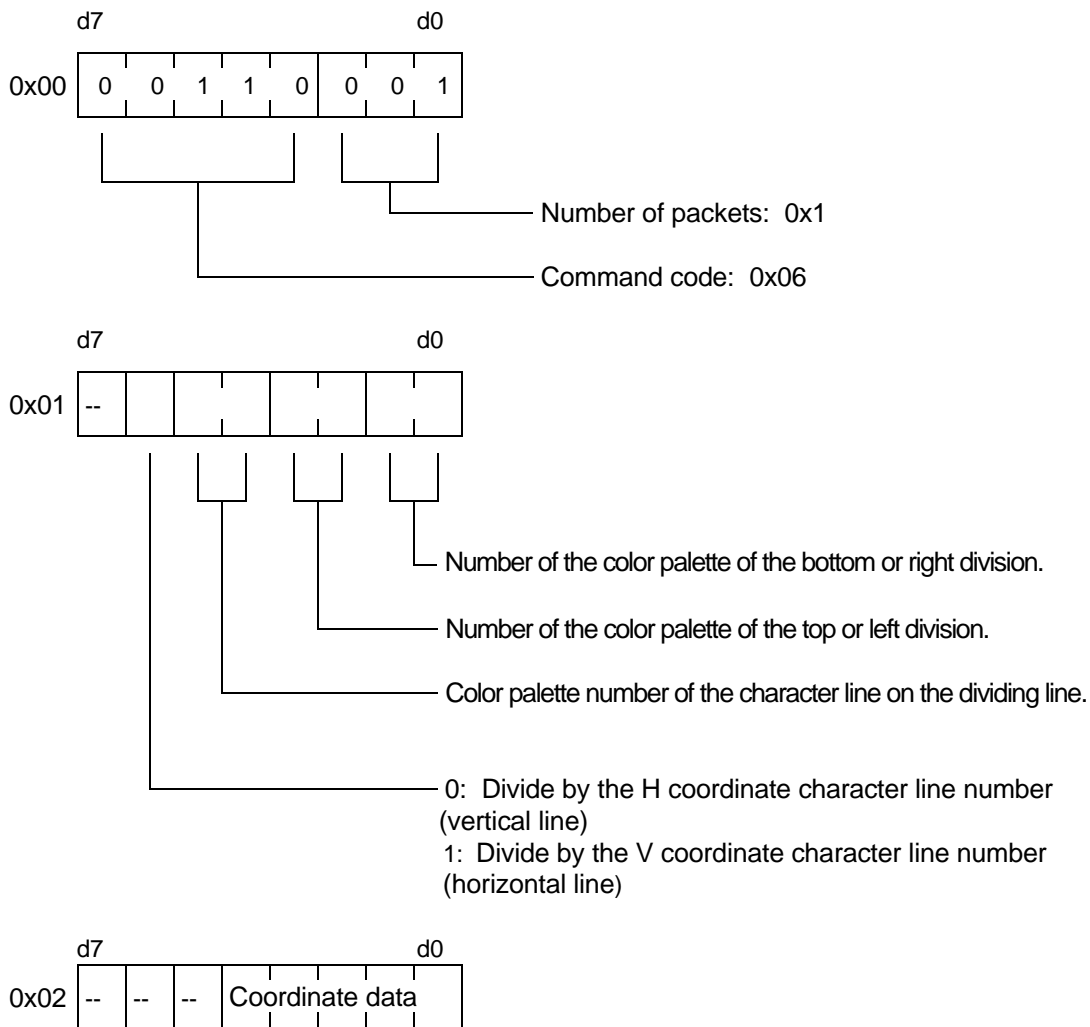

\* 0x03 - 0x0F should be filled with 0x00.

\* See note on ATTR\_BLK.

**Example**

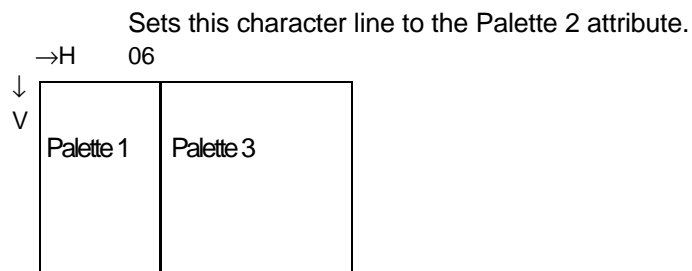
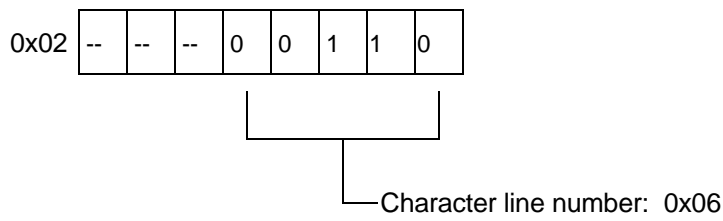
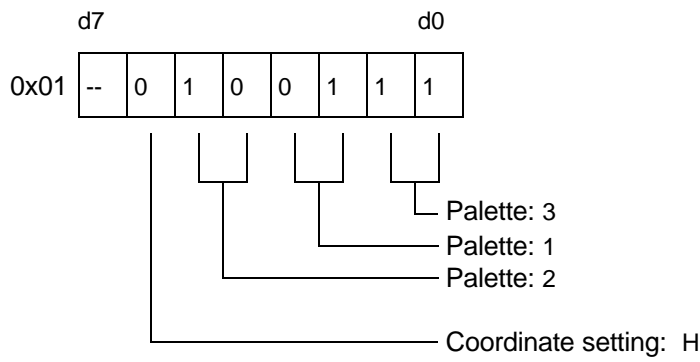
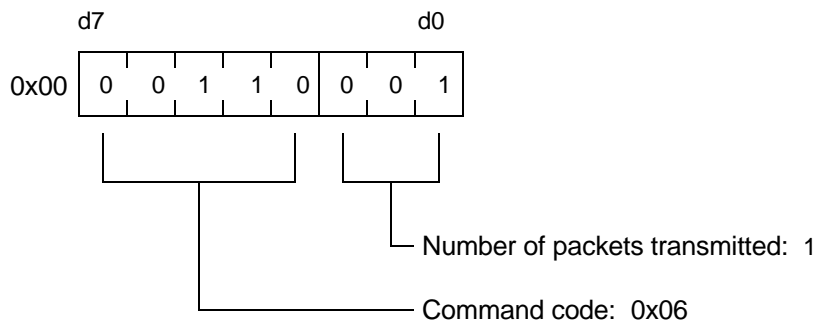

**Command: ATTRIBUTE\_CHR (Code: 0x07)**

Function: Specifies a color palette for each character.

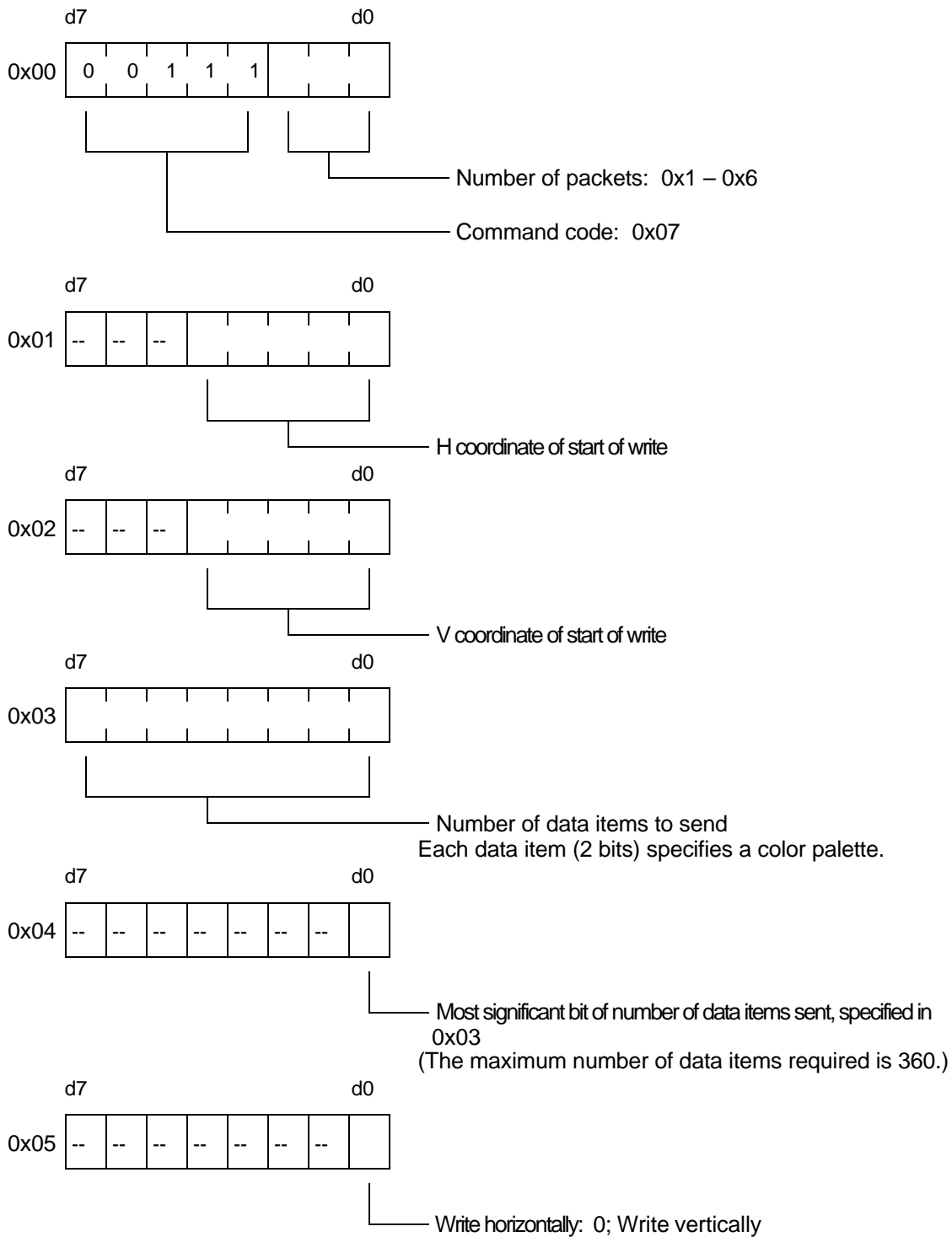

START →

0x06	Pal.No.	Pal.No.	Pal.No.	Pal.No.
0x07	Pal.No.	Pal.No.	Pal.No.	Pal.No.

: : : :

: : : :

: : : :

Sending color palette data for entire screen:

: : : :

: : : :

6<sup>th</sup> Packet

0x0E	Pal.No.	Pal.No.	Pal.No.	Pal.No.
0x0F	Pal.No.	Pal.No.	Pal.No.	Pal.No.

Horizontal write (H direction)

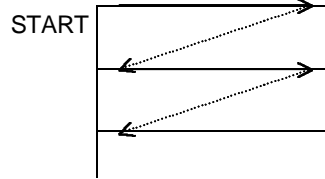

Vertical write (V direction)

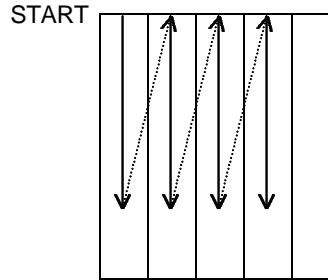

← Data items nos. 357, 358, 359, and 360.

\* See note on ATTR\_BLK.

**Command: SOUND (Code: 0x08)**

Function: Generates and halts internal sound effects and sounds that use internal tone data.

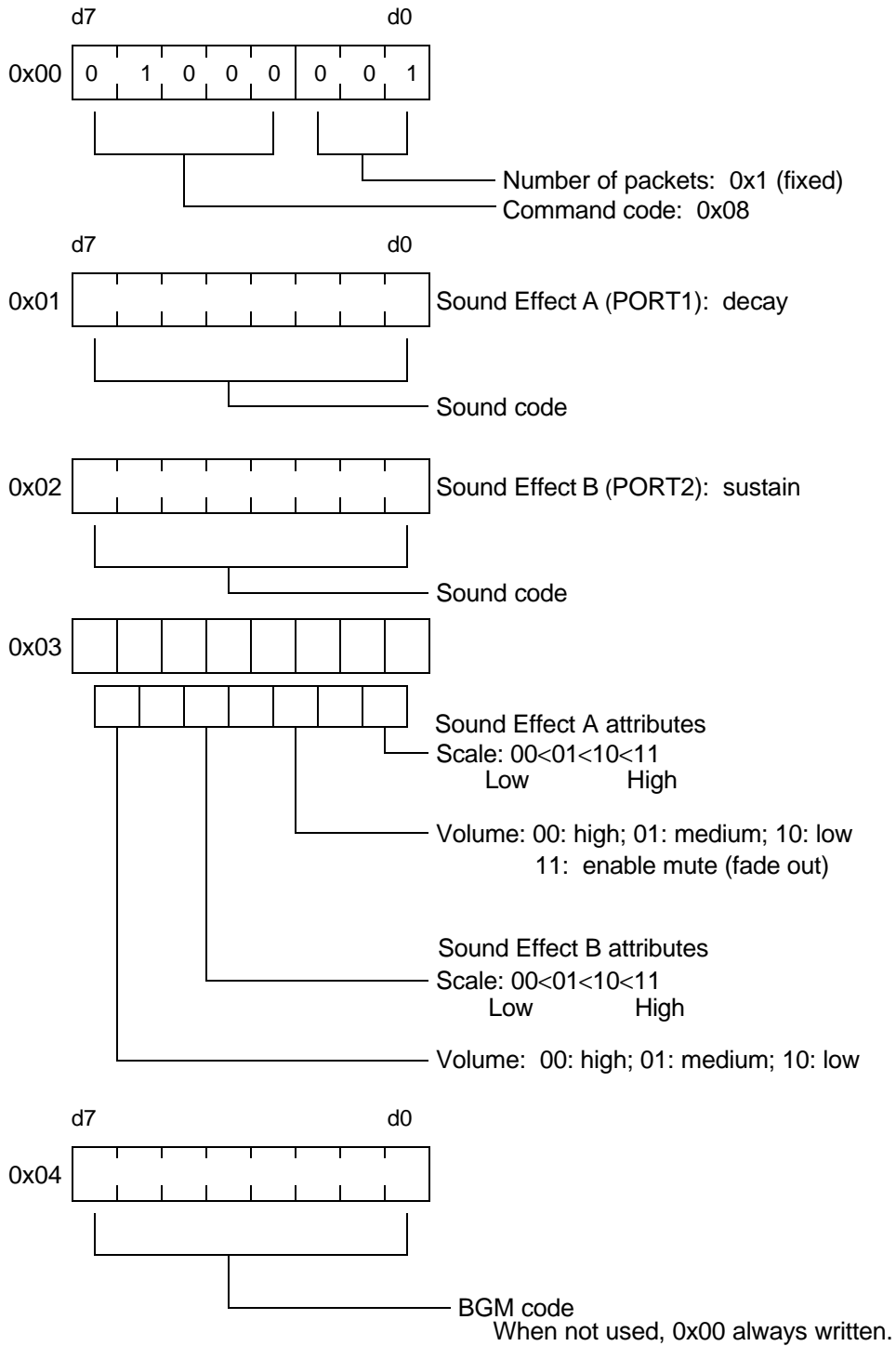

\* For more information, see Section 3.4, *Sound Flag Lists*.

**Command: *SOU\_TRN* (Code: 0x09)**

(Data transfer using VRAM)

Function: Sends a sound program and sound data to the APU.

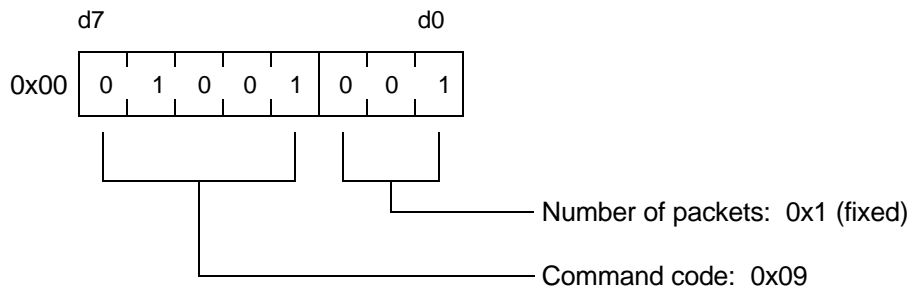

\* The 4 Kbytes of SGB RAM data immediately following the command is sent to APU RAM.

The data to be transferred must be prepared prior to the frame preceding issuance of the command.

The transfer ends 6 frames after the command is issued (not counting the frame in which the command is issued).

The beginning of the data for transfer contains a 16-bit representation of the number of data items and the transfer destination address, and the end contains an ending code and the starting address of the program. For more information, see Chapter 7: *Super Game Boy Sound*.

APU RAM program area: 0x0400 – 0x2AFF/9.75 Kbytes

APU RAM music data area: 0x2B00 – 0x4AFF/8 Kbytes

APU RAM sampling data area: 0x4DB0-0xEEFF/40.25 Kbytes

**Note** *When **SOU\_TRN** is used, 5 packets of **SOU\_TRN** initialization should be sent to the register file. For more information, see Section 5.3, **SOU\_TRN** Initialization Data.*

**Command: PAL\_SET (Code: 0x0A)**

Function: Applies system color palettes to SGB color palettes.

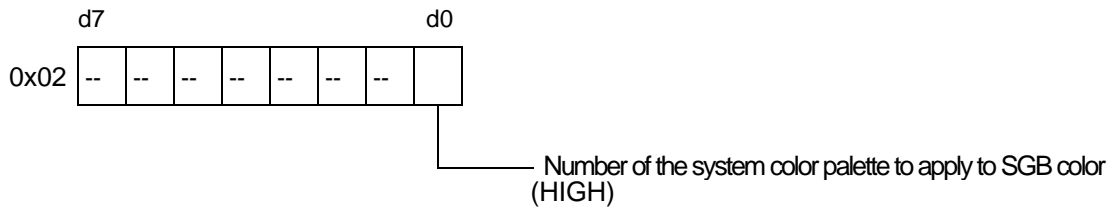
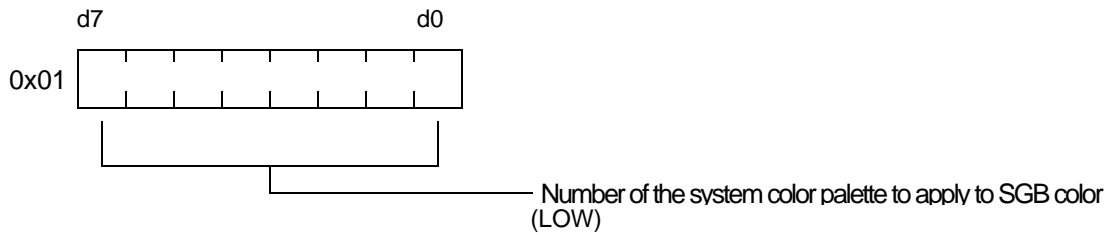
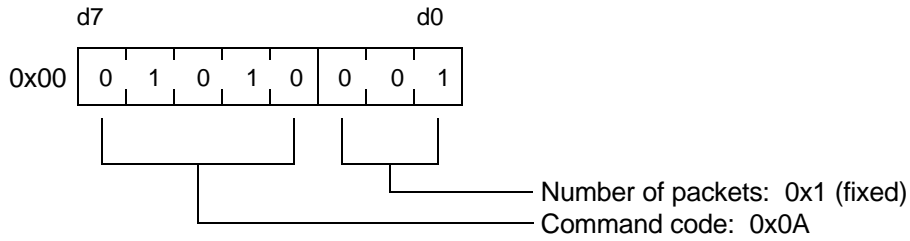

\* The system color palettes selected are palettes 000-511.

Number of the system color palette applied to SGB color palette 1.

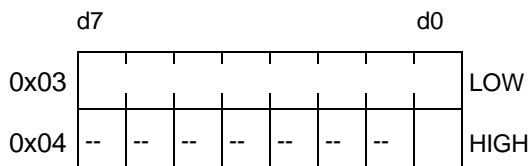

Number of the system color palette applied to SGB color palette 2.

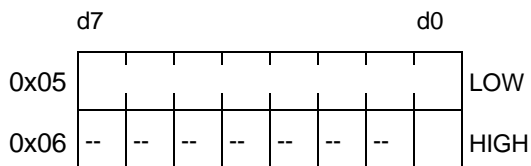

Number of the system color palette applied to SGB color palette 3.

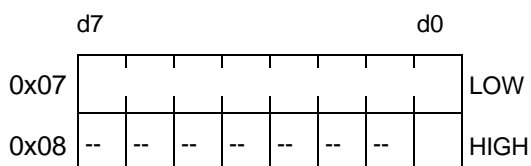



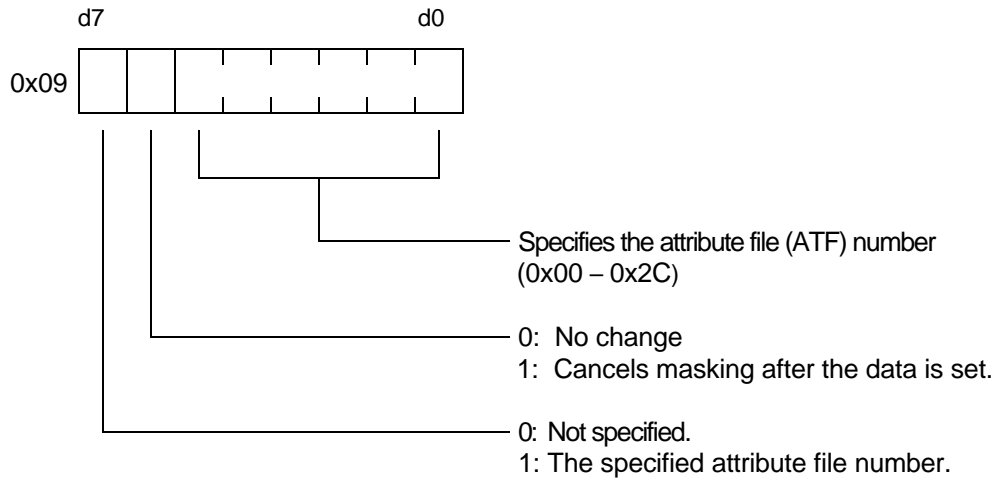

\* 0x0A - 0x0F should be filled with 0x00.

**Command: PAL\_TRN (Code: 0x0B)**

(Data Transfer using VRAM)

Function: Transfers color data to the system color palette.

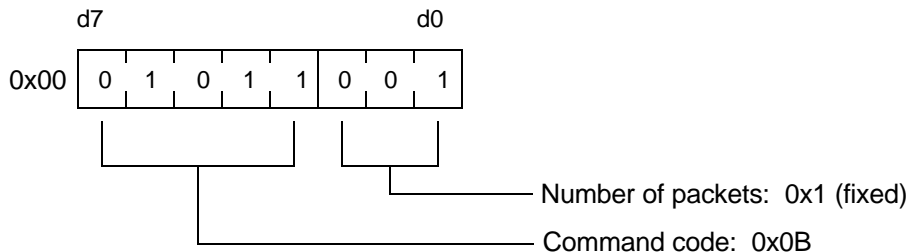

\* The 4 Kbytes of SGB RAM data immediate following the command is handled as system color palette data and stored in SUPER NES WRAM as data for system color palettes 000 – 511.

The format of data storage in SGB RAM is as follows.

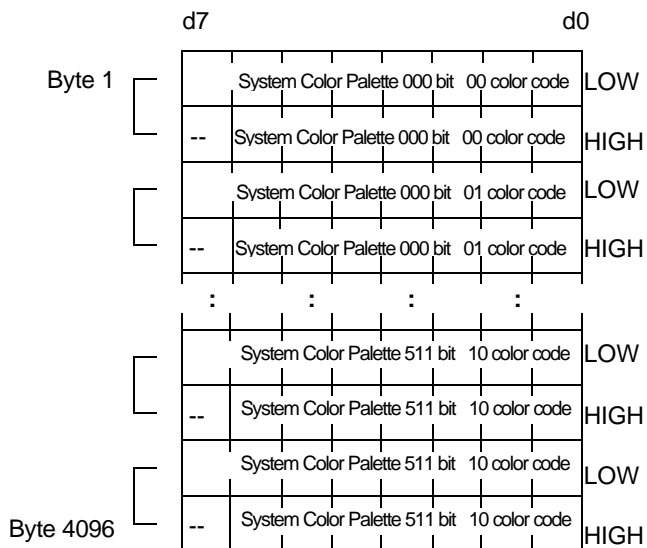

The storage addresses are 0x3000 - 0x3FFF.

**Command: ATRC\_EN (Code: 0x0C)**

Function: Enables and disables attraction mode.

Enables and disables attraction on the picture frame.  
 The default setting is enabled (0x00).  
 If the command is issued during attraction, attraction is stopped.

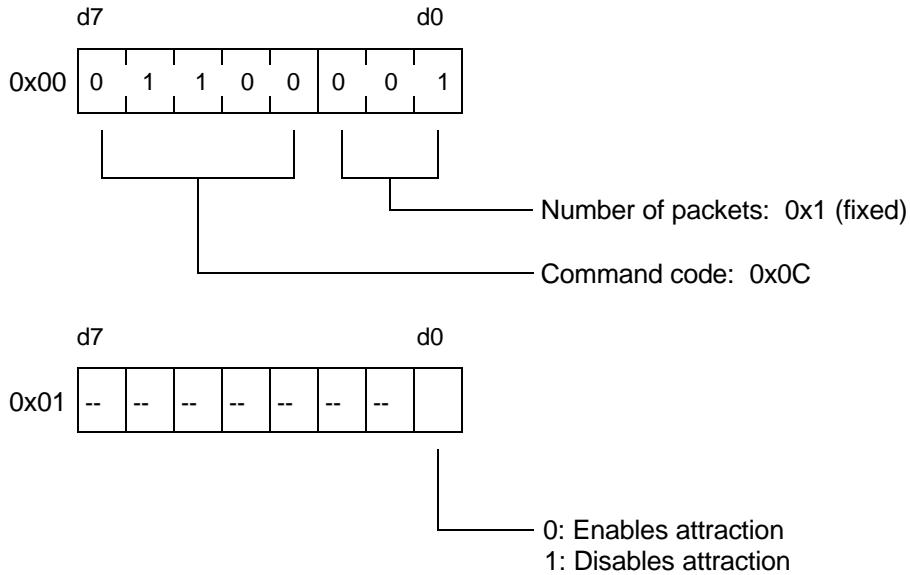

Example: Attraction start duration for a model (type without communication connector).

The time required for attraction to start for each picture frame is as follows.  
 (Times shown in parentheses are times required to start attraction a second time.)

Mario	7 min. (5 min.)
Cork	3 min. (5 min.)
Landscape	1 min. (1 min.)
Cinema	3 mins.
Cats	3 mins.
Pencils	3 mins. (5 mins.)
Escher art	7 mins. (5 mins.)

**Command: ICON\_EN (Code: 0x0E)**

Function: Enables and disables the icon function.

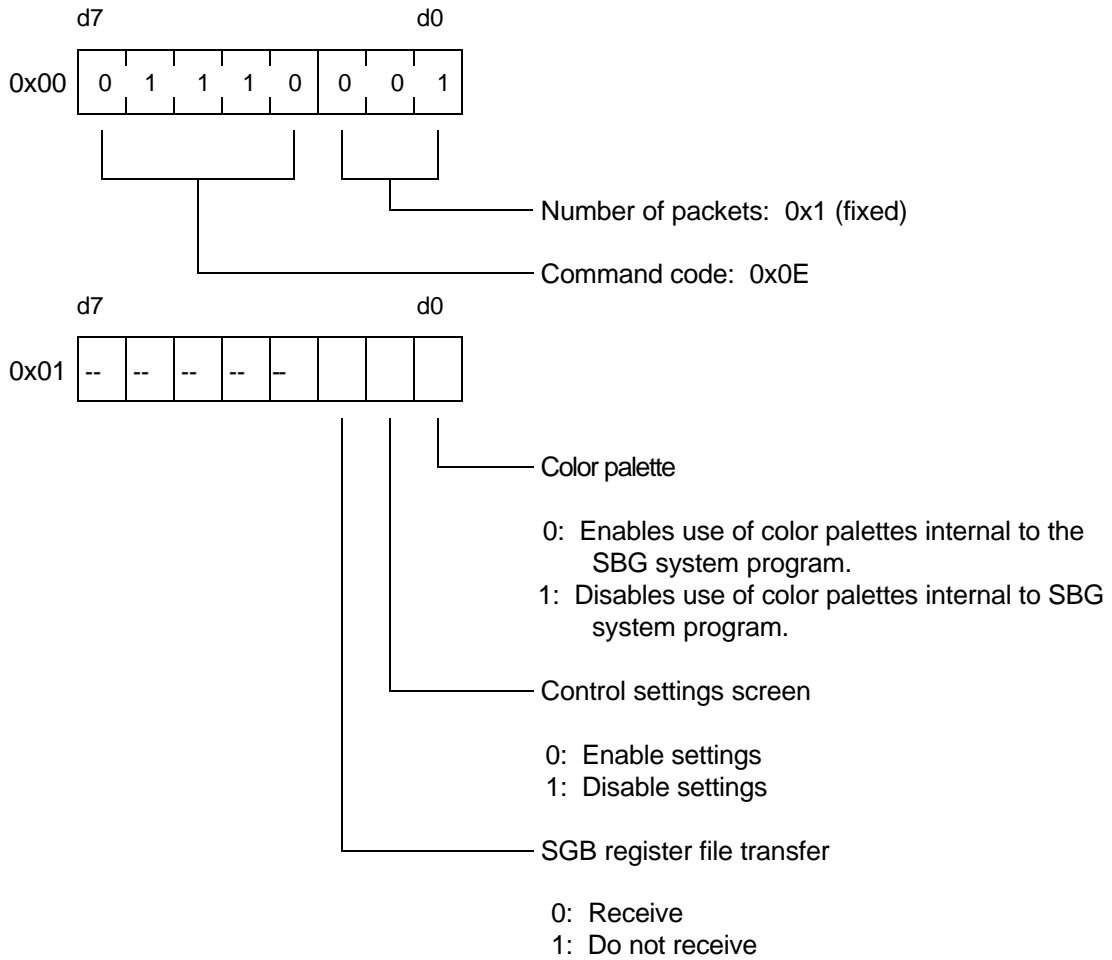

\* The default value is 0x00.

**Command: DATA\_SND (Code: 0x0F)**

Function: Transfers data to SUPER NES WRAM using the register file.

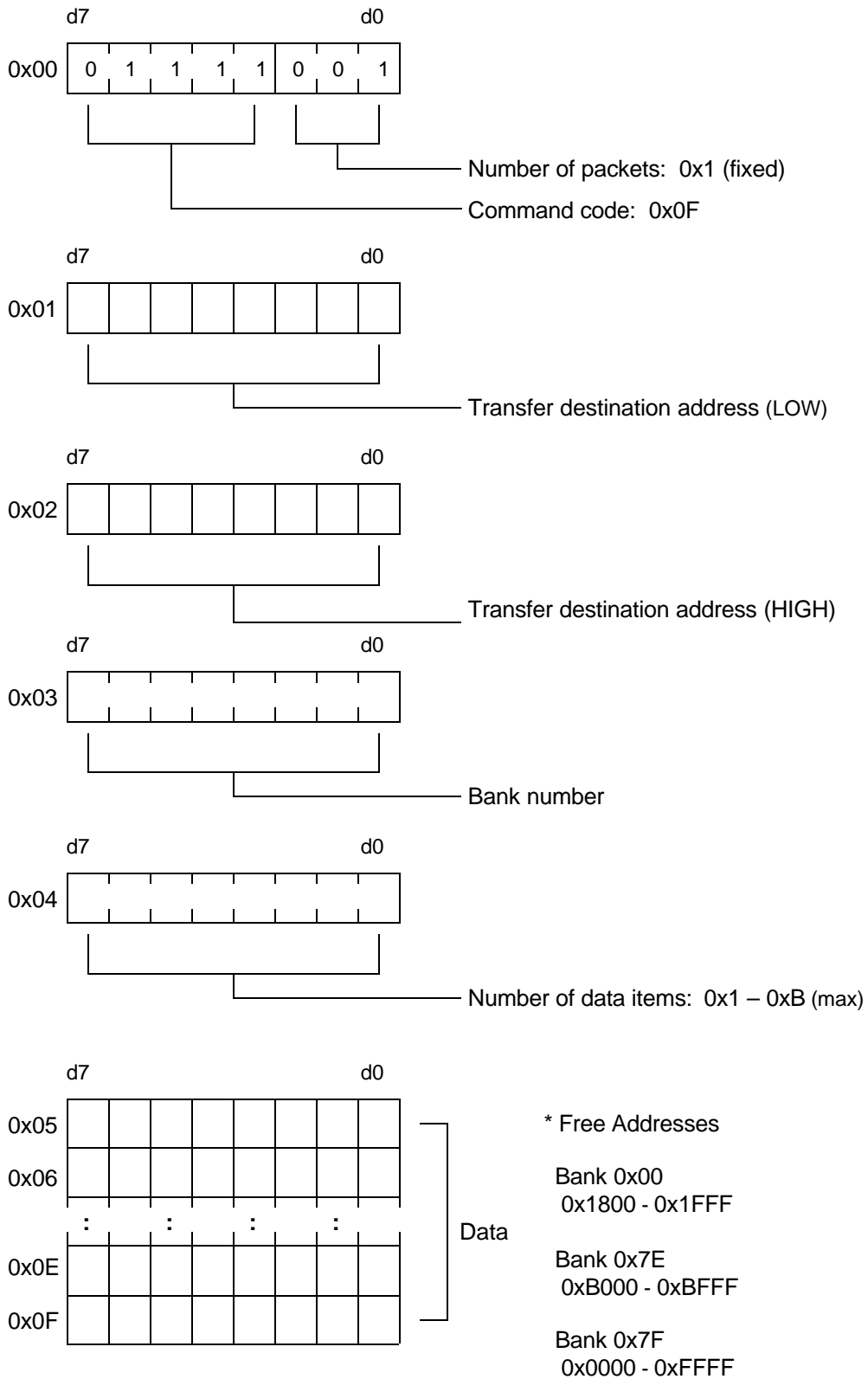

**Command: DATA\_TRN (Code: 0x10)**

(Data Transfer using VRAM)

Function: Transfers data in SGB RAM to SUPER NES WRAM.

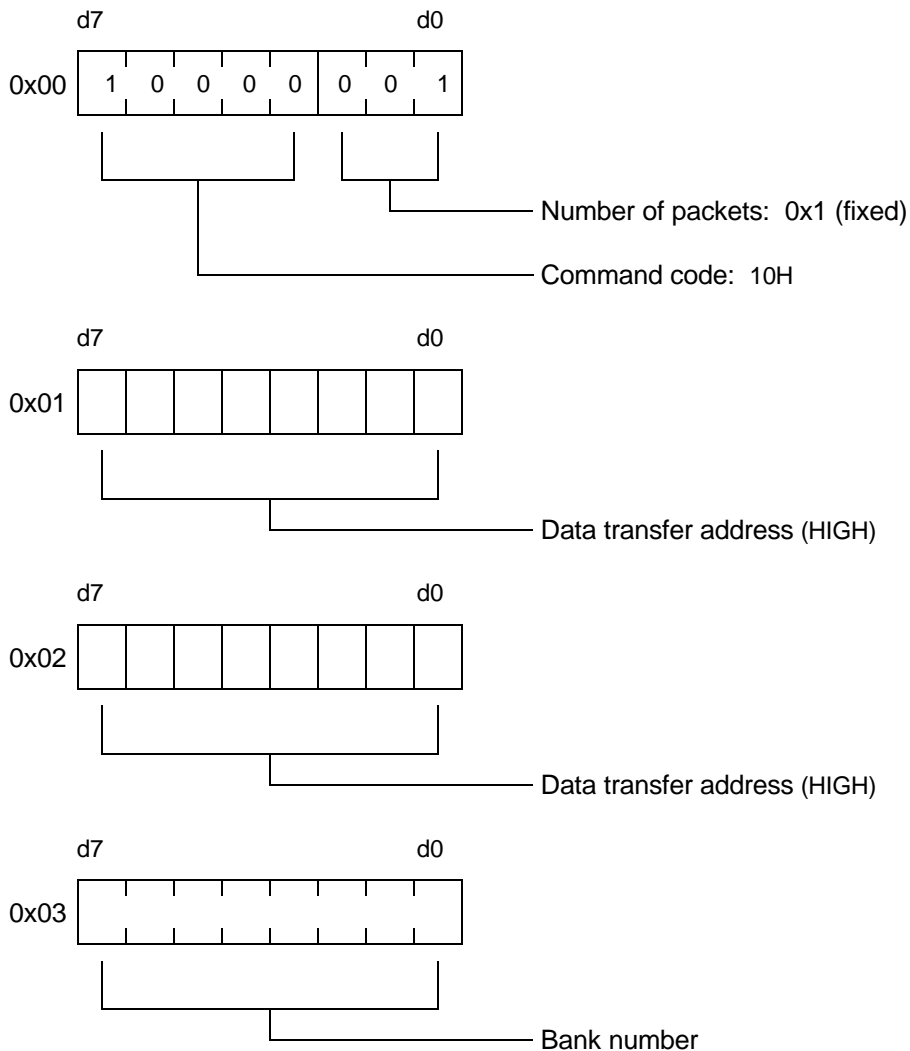

\* Free Addresses

Bank 0x00	0x1800 – 0x1FFF
Bank 0x7E	0xB000 – 0xBFFF
Bank 0x7F	0x0000 – 0xFFFF

**Note** When an SHVC program is transferred to WRAM and executed, 0x00 should be written to 0x1700 of bank 00. This can be written either by using DATA\_SND or DATA\_TRN or by using the transferred program.

**Command: *MLT\_REQ* (Code: 0x11)**

Function: Requests multiplayer mode.

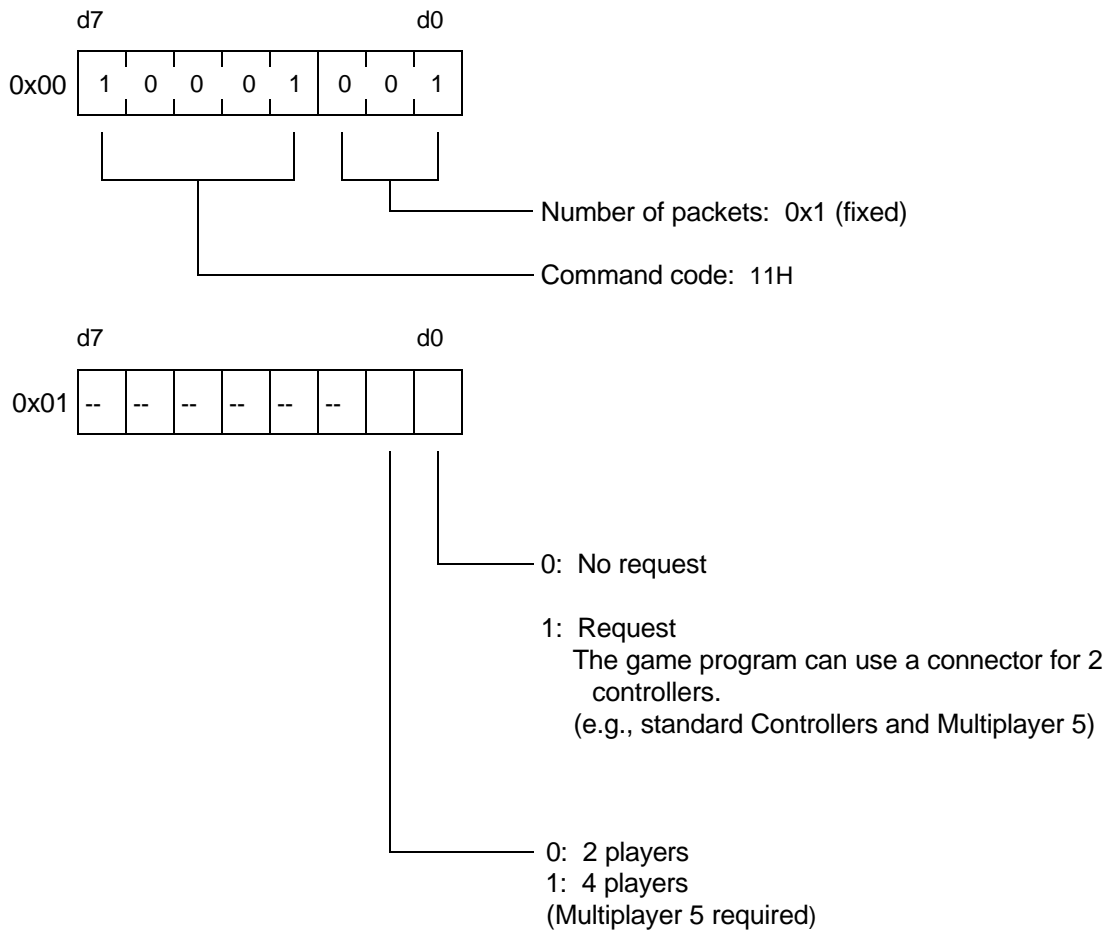

\* The default value is 0x00.

**Command: JUMP (Code: 0x12)**

Function: Sets the SUPER NES program counter to the specified address.

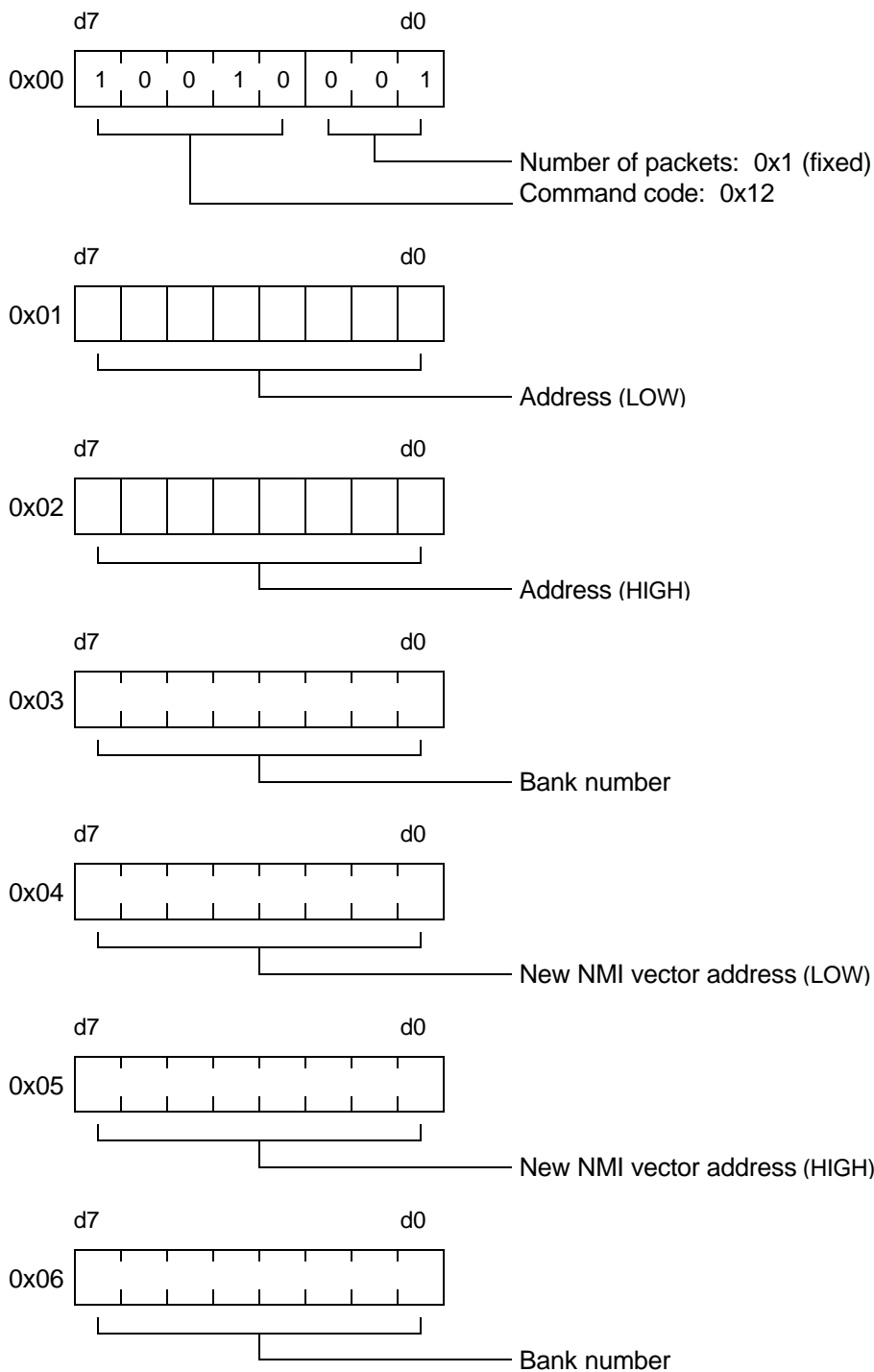

**Note** *If all addresses from 0x04 to 0x06 are set to 0, the NMI jumps to the original vector. NMI is disabled in the system program, so it must be enabled to be used.*





**Command: PCT\_TRN (Code: 0x14)**  
 (Data Transfer using VRAM)

Function: Transfers screen data and color data for picture frames created by the software developer.

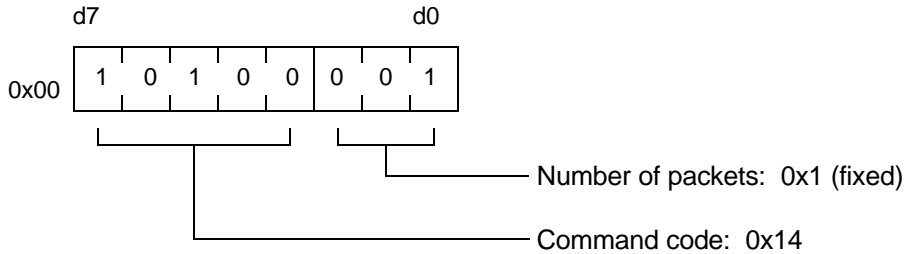

\* The 4 Kbytes of SGB RAM immediately following this command are handled as screen data and transferred to SUPER NES VRAM.

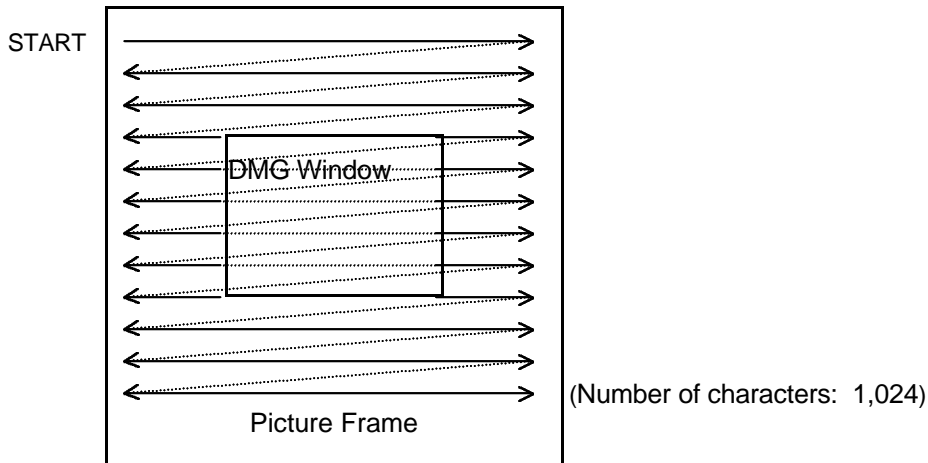

There should be 1,024 uncompressed characters of screen data.  
 The inside of the DMG window should be filled with null characters.  
 Three color palettes, 4-6, are transferred.  
 The initial data consists of 2,048 bytes of screen data. This is followed by 3 palettes of color data (2 bytes x 16 x 3).

The format of the transferred data is based on that of SUPER NES screen and color data. However, the BG priority bit is set to 0, the color palettes to palette numbers 4-6, the higher-order 2 bits of the character name to 00b, and the characters to 8 x 8-bit mode.

**Command: ATTR\_TRN (Code: 0x15)**  
 (Data Transfer using VRAM)

Function: Transfers attribute files.

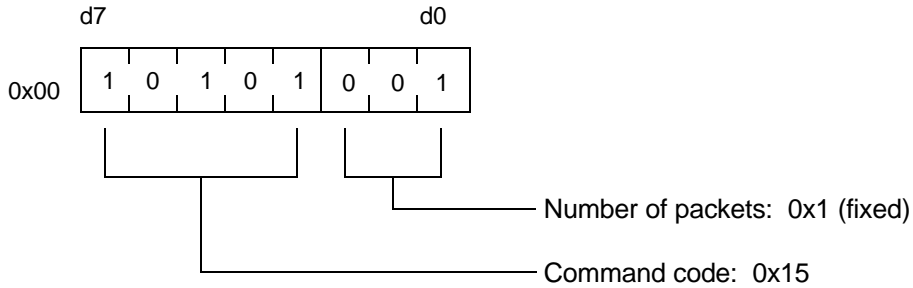

\* The 4 Kbytes of SGB RAM immediately following this command are transferred to WRAM as attribute files. (The capacity of each attribute file is  $2 \times 20 \times 18/8 = 90$  bytes. Thus, 45 attribute files occupy 4,050 bytes, 0xATF0-0xATF44.

The ATF data format (90 bytes total) -- written horizontally from the left edge of the DMG window.

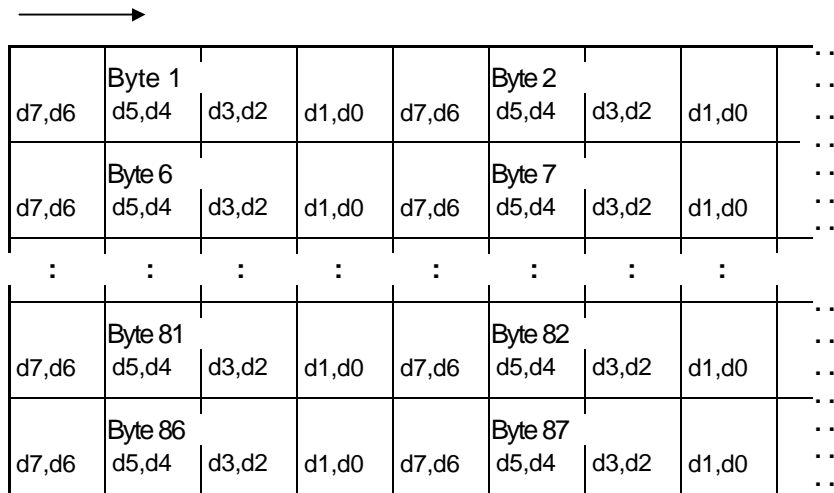

(The figure depicts a DMG window with 20 x 18 characters.)

**Command: ATTR\_SET (Code: 0x16)**

Function: Applies the specified attribute file to the DMG window.

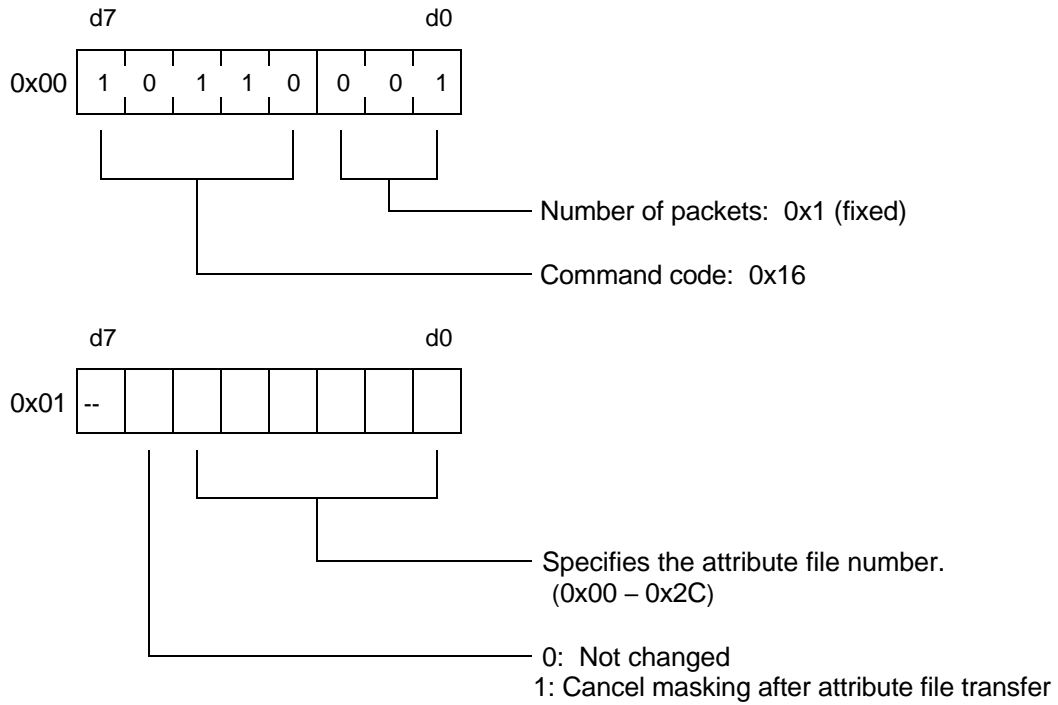

\* 0x02 - 0x0F filled with 0x00.

**Command: MASK\_EN (Code: 0x17)**

Function: Masks the DMG window.

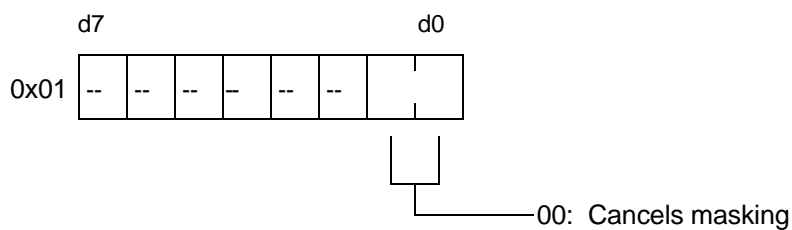
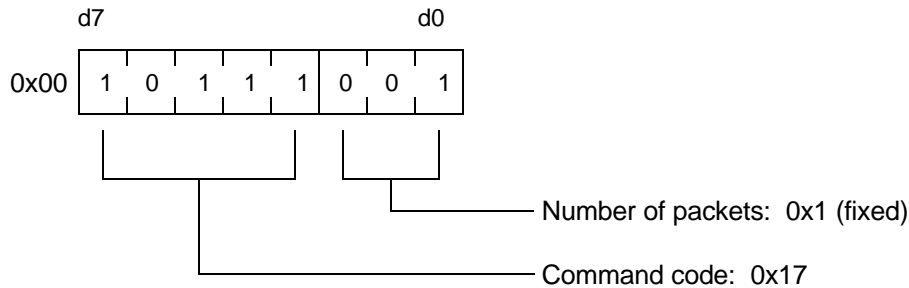

01: Freezes the screen immediately before masking.  
(No transfers to SUPER NES VRAM are performed from after the command is issued until masking is canceled.)

10: Masks by setting all SGB color palette color codes to black.

11: Masks by setting all SGB color palette color codes to the same color (color of bit 00).

\* 0x2- 0xF filled with 0x00.

**Note** *When masking is performed at the start of the game, it should be performed after the DMG reset is canceled and around the time that the DMG screen is displayed on SGB. (The timing of the command should be adjusted so that it is issued after a wait of several frames.) Without this timing, the screen may be momentarily be displayed in monochrome.*

**Note** *Masking with an argument (0X01) of 0x10 or 0x11 is prohibited during a game.*

**Command: PAL\_PRI (Code: 0x19)**

Function: Specifies the priority of the color palette for the application and the color palette selected by the player.

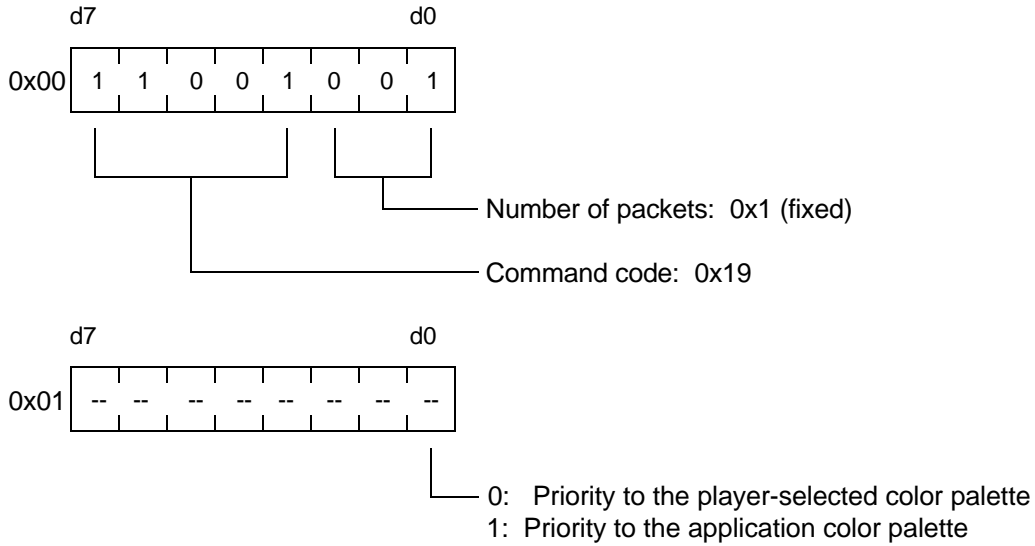

\* Default is 0.

**Priority to Player-Selected Color Palette**

When a screen that uses a player-selected color palette is displayed, any color or attribute settings commands that were sent have no effect on the DMG window.

**Priority to Application Color Palette**

When a screen that uses a player-selected color palette is displayed and a color or attribute setting command was sent, the sent colors are displayed in the DMG window.

\* The corresponding commands are as follows.

00, 01, 02, 03, 04, 05, 06, 07, 0A, 16 (Code value)

### 3.3 Cautions Regarding Sending Commands

- After each packet (128 bits) is sent, 0 must always be sent in bit 129.
- If a data sequence covers more than 1 packet, byte 1 of each packet after the first is a continuation of the data of the previous packet.
- 0x00 is written to the unused areas in each packet.
- Note that there are two modes of data transfer: register-file mode and a mode in which 4 Kbytes are transferred using SGB RAM.
- Controller key input should not be read while a command is being sent.

### 3.4 Sound Flag Summary

- Pre-loaded sound effects A and B can be played simultaneously using system commands.
- The A sound effects are formants, primarily action sounds, and the B sound effects are looping sounds, primarily ambient sounds.
- The interval (frequency) for these sound effects can be set to 4 levels.
- Changing the interval A allows a completely different sound effect to be obtained with the same sound source. In addition, the volume can be set to 3 levels.

### 3.4.1 Sound Effect A Flags

SOUND Command			
0x01	d7-d0 [bit]	0x03 d1-d0 [bit]	
Code	Flag Meaning	Recommended Interval Value	Voices Used
0x00	Dummy flag for retriggering		• • 6 • 7
0x80	Sound effect A stop (mute)		• • 6 • 7
0x01	Nintendo	d1 = 1 • d0 = 1	• • • 7
0x02	Game over sound	d1 = 1 • d0 = 1	• • 6 • 7
0x03	Falling sound	d1 = 1 • d0 = 1	• • • 7
0x04	Predetermined sound • • • A	d1 = 1 • d0 = 1	• • 6 • 7
0x05	Predetermined sound • • • B	d1 = 1 • d0 = 1	• • 6 • 7
0x06	Selected sound • • • A	d1 = 1 • d0 = 1	• • 6 • 7
0x07	Selected sound • • • B	d1 = 1 • d0 = 1	• • • 7
0x08	Selected sound • • • C	d1 = 1 • d0 = 0	• • 6 • 7
0x09	Error sound • • • buzzer	d1 = 1 • d0 = 0	• • • 7
0x0A	Item-catch sound	d1 = 1 • d0 = 0	• • 6 • 7
0x0B	One knock on door	d1 = 1 • d0 = 0	• • 6 • 7
0x0C	Explosion • • • small	d1 = 1 • d0 = 1	• • 6 • 7
0x0D	Explosion • • • medium	d1 = 1 • d0 = 1	• • 6 • 7
0x0E	Explosion • • • large	d1 = 1 • d0 = 1	• • 6 • 7
0x0F	Defeat sound • • • A	d1 = 1 • d0 = 1	• • • 7
0x10	Defeat sound • • • B	d1 = 1 • d0 = 1	• • 6 • 7
0x11	Striking sound (attack) • • • A	d1 = 1 • d0 = 0	• • 6 • 7
0x12	Striking sound (attack) • • • B	d1 = 1 • d0 = 0	• • 6 • 7
0x13	Air-sucking sound	d1 = 1 • d0 = 0	• • 6 • 7
0x14	Rocket launcher • • • A	d1 = 1 • d0 = 1	• • 6 • 7
0x15	Rocket launcher • • • B	d1 = 1 • d0 = 1	• • 6 • 7
0x16	Bubbling sound (in water)	d1 = 1 • d0 = 0	• • • 7



SOUND Command			
0x01	d7-d0 [bit]	0x03 d1-d0 [bit]	
Code	Flag Meaning	Recommended Interval Value	Voices Used
0x17	Jump	d1 = 1 • d0 = 1	• • • 7
0x18	Fast jump	d1 = 1 • d0 = 1	• • • 7
0x19	Jet (rocket) firing	d1 = 1 • d0 = 0	• • • 7
0x1A	Jet (rocket) landing	d1 = 1 • d0 = 0	• • • 7
0x1B	Cup breaking	d1 = 1 • d0 = 0	• • 6 • 7
0x1C	Glass breaking	d1 = 1 • d0 = 1	• • 6 • 7
0x1D	Level up	d1 = 1 • d0 = 0	• • 6 • 7
0x1E	Air injection	d1 = 1 • d0 = 1	• • • 7
0x1F	Sword wielding	d1 = 1 • d0 = 1	• • • 7
0x20	Falling in water	d1 = 1 • d0 = 0	• • • 7
0x21	Fire	d1 = 1 • d0 = 1	• • • 7
0x22	Breaking wall	d1 = 1 • d0 = 1	• • 6 • 7
0x23	Cancellation sound	d1 = 1 • d0 = 0	• • 6 • 7
0x24	Stepping	d1 = 1 • d0 = 1	• • 6 • 7
0x25	Block-hitting sound	d1 = 1 • d0 = 1	• • 6 • 7
0x26	Sound of picture floating into view	d1 = 1 • d0 = 1	• • 6 • 7
0x27	Screen fade-in	d1 = 1 • d0 = 0	• • 6 • 7
0x28	Screen fade-out	d1 = 1 • d0 = 0	• • 6 • 7
0x29	Window opening	d1 = 1 • d0 = 1	• • 6 • 7
0x2A	Window closing	d1 = 1 • d0 = 0	• • 6 • 7
0x2B	Large laser sound	d1 = 1 • d0 = 1	• • 6 • 7
0x2C	Sound of stone door closing (opening)	d1 = 1 • d0 = 0	• • 6 • 7
0x2D	Teleportation	d1 = 1 • d0 = 1	• • • 7
0x2E	Thunder	d1 = 1 • d0 = 0	• • 6 • 7
0x2F	Earthquake	d1 = 1 • d0 = 0	• • 6 • 7
0x30	Small laser sound	d1 = 1 • d0 = 0	• • 6 • 7

### 3.4.2 Sound Effect B Flags

SOUND Command			
0x02 d7-d0 [bit]		0x03 d5-d4 [bit]	
Code	Flag Meaning	Recommended Interval Value	Voices Used
0x00	Dummy flag for retriggering		0 • 1 • 4 • 5
0x80	Sound Effects B stop (mute)		0 • 1 • 4 • 5
0x01	Applause • • • small crowd	d5 = 1 • d4 = 0	• • • 5
0x02	Applause • • • medium crowd	d5 = 1 • d4 = 0	• • 4 • 5
0x03	Applause • • • large crowd	d5 = 1 • d4 = 0	0 • 1 • 4 • 5
0x04	Wind	d5 = 0 • d4 = 1	• • 4 • 5
0x05	Rain	d5 = 0 • d4 = 1	• • • 5
0x06	Storm	d5 = 0 • d4 = 1	• 1 • 4 • 5
0x07	Hurricane	d5 = 1 • d4 = 0	0 • 1 • 4 • 5
0x08	Thunder	d5 = 0 • d4 = 0	• • 4 • 5
0x09	Earthquake	d5 = 0 • d4 = 0	• • 4 • 5
0x0A	Lava flow	d5 = 0 • d4 = 0	• • 4 • 5
0x0B	Wave	d5 = 0 • d4 = 0	• • • 5
0x0C	River	d5 = 1 • d4 = 1	• • 4 • 5
0x0D	Waterfall	d5 = 1 • d4 = 0	• • 4 • 5
0x0E	Small character running	d5 = 1 • d4 = 1	• • • 5
0x0F	Horse galloping	d5 = 1 • d4 = 1	• • • 5
0x10	Warning sound	d5 = 0 • d4 = 1	• • • 5
0x11	Futuristic car running	d5 = 0 • d4 = 0	• • • 5
0x12	Jet flying	d5 = 0 • d4 = 1	• • • 5
0x13	UFO flying	d5 = 1 • d4 = 0	• • • 5
0x14	Electromagnetic waves	d5 = 0 • d4 = 0	• • • 5
0x15	Sound of score being raised	d5 = 1 • d4 = 1	• • • 5

SOUND Command			
	0x02 d7-d0 [bit]	0x03 d5-d4 [bit]	
Code	Flag Meaning	Recommended Interval Value	Voices Used
0x16	Fire	d5 = 1 • d4 = 0	• • • 5
0x17	Camera shutter (formant)	d5 = 0 • d4 = 0	0 • 1 • 4 • 5
0x18	Writing (formant)	d5 = 0 • d4 = 0	• • • 5
0x19	Erasing (formant)	d5 = 0 • d4 = 0	• • • 5
0x81	Use prohibited (used by system)		
0x82	Use prohibited (used by system)		

### 3.4.2 Attributes of A and B Sound Effects

SOUND Command									
0x03									
	d7	d6	d5	d4	d3	d2	d1	d0	
A Sound Effects					x	x	0	0	Interval (short)
					x	x	0	1	Interval (med-short)
					x	x	1	0	Interval (med-long)
					x	x	1	1	Interval (long)
					0	0	x	x	Volume (high)
					0	1	x	x	Volume (med)
					1	0	x	x	Volume (low)
B Sound Effects	x	x	0	0					Interval (short)
	x	x	0	1					Interval (med-short)
	x	x	1	0					Interval (med-long)
	x	x	1	1					Interval (long)
	0	0	x	x					Volume (high)
	0	1	x	x					Volume (med)
	1	0	x	x					Volume (low)
				1	1			Mute ON	

- Mute takes effect only when both bits d2 and d3 are set to 1. If the volume is set for either the A or B sound effect, mute is turned off.
- Fade-out and fade-in take effect with mute-on and mute-off, respectively. Mute-on and mute-off are implemented for BGM played by A and B sound effects and by the APU.
- There is no independent mute-off flag.
- When the mute flag is set, the volume and interval data for the A (Port 1) and B (Port 2) sound effects also should be set.

## 4. MISCELLANEOUS

### 4.1 Reading Input from Multiple Controllers

After a multiplayer request (Command MLT\_REQ) is sent, data from controllers 1, 2, 3, and 4 automatically become readable.

In 2-player mode, data from controller 1 is read first, followed by data from controller 2, then data from controller 1 again, and so on. In 4-player mode, the order is controller 1, controller 2, controller 3, controller 4, controller 1 again, and so on.

In these cases, the next controller for which data is to be read must be determined beforehand by reading P10-P13 with P14 and P15 high.

P10 - P13	Next Controller to Read
0xF	Controller 1
0xE	Controller 2
0xD	Controller 3
0xC	Controller 4

**Note** *Controller data cannot be read if Multiplayer 5 and SUPER NES Mouse are connected at the same time.*

## 4.2 RECOGNIZING SGB

### 4.2.1 Distinguishing between Game Boy types (DMG, MGB/MGL, SGB, and SGB2)

The program uses the following methods to determine which of the 4 types is operating.

- Checks the initial value of the internal accumulator of the CPU. (distinguishes between previous/new versions of CPU).

01 → DMG or SGB  
FF → MGB/MGL or SGB2

- Sends a multiplayer request (Command MLT\_REQ) and determines whether there is a switch to multiplayer mode.

No switch → DMG or MGB/MGL  
Switch → SGB or SGB2

\* The following table summarizes these methods.

Initial Value of CPU Internal Accumulator	Switch/No Switch to Multiplayer Mode	Game Boy Type
01	No switch	DMG
	Switch	SGB
FF	No switch	MGB/MGL
	Switch	SGB2

4.2.2 Usage Example: Distinguishing Between the 4 Game Boy Types

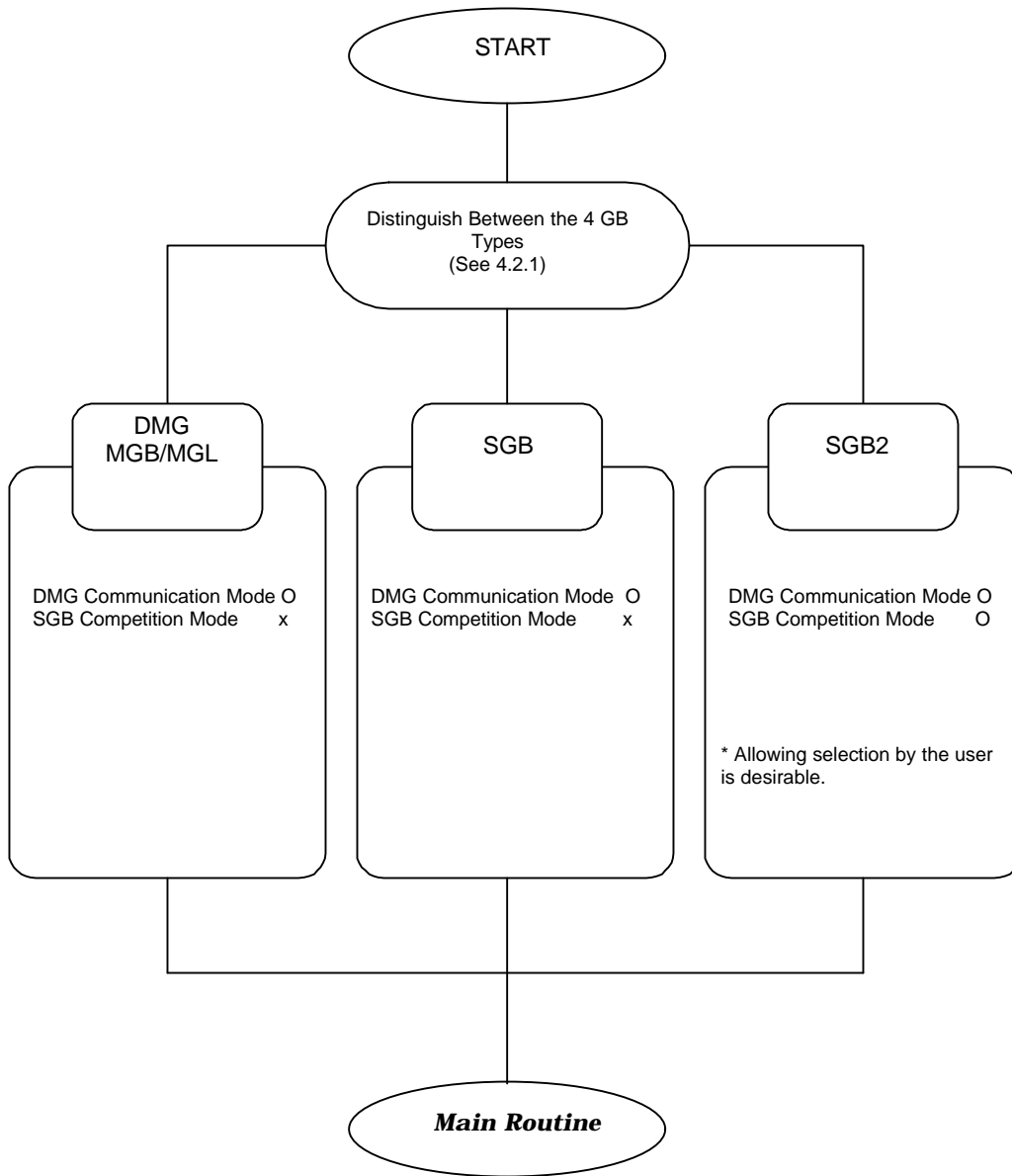

\* A sample program for distinguishing between GB types is provided.

### 4.3 SGB Register Summary

The following registers can be used to perform functions such as resetting the SGB CPU from a program transferred to SUPER NES WRAM and receiving and passing data to a DMG program.

Register File Status  
[RFS] 0x6002 (RD)

Reads the status of the register file



1: Ready  
0: mid-transfer or read finished

DMG Reset Register  
[DRR] 0x6003 (WR)

Resets the SGB CPU

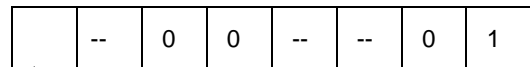

0: Reset  
1: Cancel

Controller Register1  
[CR1] 0x6004 (WR)

Writes data from controller 1

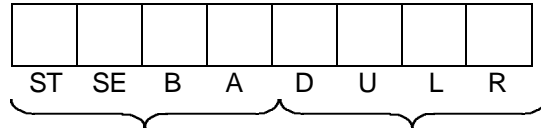

Data read at P15..... Data read at P14

Register File  
[RF<sub>0</sub> - RF<sub>F</sub>] 0x7000 - 0x700F (RD)

Register file for communication

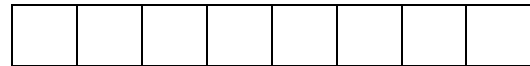

\* The RFS flag (0x6002) is cleared to 0 by the reading of 0x7000.

The SGB CPU can be reset using DRR.

Using RF<sub>0</sub> - RF<sub>F</sub> and RFS allows data sent to the register file by the DMG program to be received by the SUPER NES program.

CR1 is a register used by the original SGB system program for writing keypad data from controller 1. The SUPER NES program can use the controller-reading routine of the DMG program to receive data written to this register.



4.4 Flowchart of Initial Settings Routine

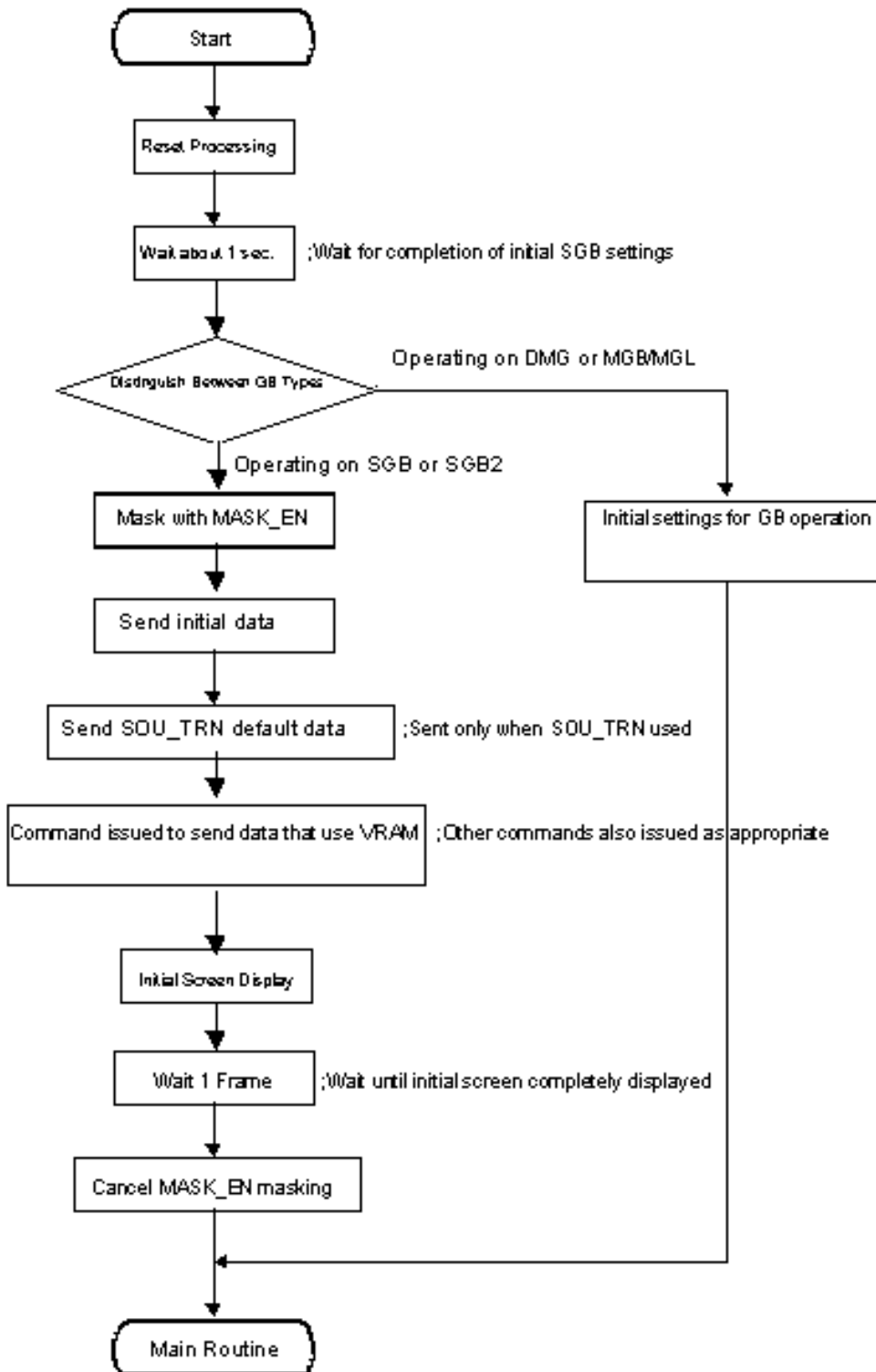

## 5. PROGRAMMING CAUTIONS

### 5.1 ROM Registration Data

To use SGB functions (system commands), the following values must be stored at the ROM addresses indicated.

x146 ← 0x03    and    0x14B ← 0x33

### 5.2 Initial Data

When writing programs that use the system commands of SGB and SGB2, use the initialization routine of the game program to send the following 8 packets of default data to the register file.

```
INIT1  DEFB  $79,$5D,$08,$00,$0B,$8C,$D0,$F4,$60,$00,$00,$00,$00,$00,$00
INIT2  DEFB  $79,$52,$08,$00,$0B,$A9,$E7,$9F,$01,$C0,$7E,$E8,$E8,$E8,$E0
INIT3  DEFB  $79,$47,$08,$00,$0B,$C4,$D0,$16,$A5,$CB,$C9,$05,$D0,$10,$A2,$28
INIT4  DEFB  $79,$3C,$08,$00,$0B,$F0,$12,$A5,$C9,$C9,$C8,$D0,$1C,$A5,$CA,$C9
INIT5  DEFB  $79,$31,$08,$00,$0B,$0C,$A5,$CA,$C9,$7E,$D0,$06,$A5,$CB,$C9,$7E
INIT6  DEFB  $79,$26,$08,$00,$0B,$39,$CD,$48,$0C,$D0,$34,$A5,$C9,$C9,$80,$D0
INIT7  DEFB  $79,$1B,$08,$00,$0B,$EA,$EA,$EA,$EA,$EA,$A9,$01,$CD,$4F,$0C,$D0
INIT8  DEFB  $79,$10,$08,$00,$0B,$4C,$20,$08,$EA,$EA,$EA,$EA,$EA,$60,$EA,$EA
```

**5.3 SOU\_TRN initial data**

When using the SOU\_TRN system command, send the following 5 packets of SOU\_TRN default data to the register file before SOU\_TRN is used.

```

ST1
DB   $79, $00, $09, $00, $0B
DB   $AD, $C2, $02, $C9, $09, $D0, $1A, $A9, $01, $8D, $00

ST2
DB   $79, $0B, $09, $00, $0B
DB   $42, $AF, $DB, $FF, $00, $F0, $05, $20, $73, $C5, $80

ST3
DB   $79, $16, $09, $00, $0B
DB   $03, $20, $76, $C5, $A9, $31, $8D, $00, $42, $68, $68

ST4
DB   $79, $21, $09, $00, $01
DB   $60, $00, $00, $00, $00, $00, $00, $00, $00, $00, $00

ST5
DB   $79, $00, $08, $00, $03
DB   $4C, $00, $09, $00, $00, $00, $00, $00, $00, $00, $00

```

***THIS PAGE WAS INTENTIONALLY LEFT BLANK.***

<b>Chapter 7: Super Game Boy Sound</b> .....	<b>182</b>
<b>1. SGB Sound Program Overview</b> .....	<b>182</b>
<b>2. Memory Mapping (SUPER NES APU)</b> .....	<b>183</b>
<b>3. Creating and Transferring Score Data</b> .....	<b>184</b>
<b>3.1 Transferring Score Data</b> .....	<b>184</b>
<b>3.2 Summary of BGM Flags</b> .....	<b>184</b>
<b>3.3 Overview of Creating Score Data</b> .....	<b>185</b>
<b>3.4 Setting the NEWS System Working Environment</b> .....	<b>185</b>
<b>3.5 Setting the Working Environment When Using IS-SOUND</b> .....	<b>189</b>
<b>3.6 Score Data Format When Using Original Tools</b> .....	<b>190</b>
<b>3.7 Cautions Regarding Production of Musical Pieces</b> .....	<b>202</b>
<b>3.8 Format of Transferred Data</b> .....	<b>203</b>
<b>4. SGB Sound Program Source List</b> .....	<b>205</b>
<b>5. Transferring Audio Data to the Score Area</b> .....	<b>208</b>
<b>5.1 Required Data and Procedure for Audio Output</b> .....	<b>208</b>
<b>5.2 Transfer File Example</b> .....	<b>209</b>

## **CHAPTER 7: SUPER GAME BOY SOUND**

### **1. SGB SOUND PROGRAM OVERVIEW**

The SGB sound program is a special SGB program built into the SGB system program. The sound program is automatically transferred to the SNES APU at system startup.

Using the SGB system commands, pre-loaded sound effects in the sound program can be used in Game Boy application programs that support SGB (SGB software).

These commands can be used to set each of the 73 types of pre-loaded sound effects to 4 intervals (playback frequencies) and 3 volume levels.

Also preloaded are music data for BGM (instruments sound sampling data). This easily allows play of score data created with Kankichi-kun, the tool for creating SNES scores, and score data for KAN.ASM, the standard driver that is a software tool for IS-SOUND.

In addition, information on the SGB score data format has been made openly available, allowing those using tools other than the NEWS system or IS-SOUND to create score data in this format.

## 2. MEMORY MAPPING (SUPER NES APU)

[ APU Addresses ]

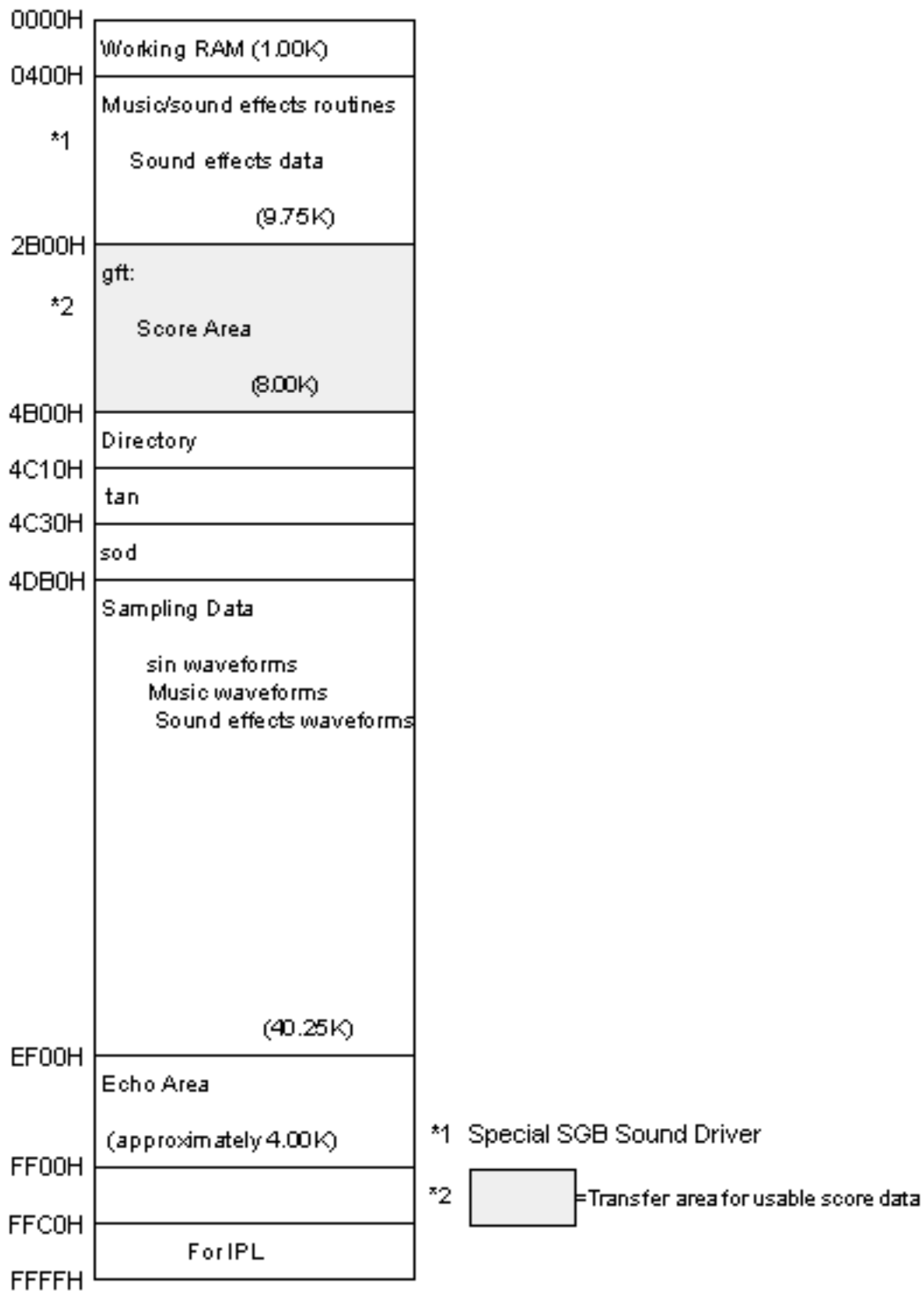

### 3. CREATING AND TRANSFERRING SCORE DATA

#### 3.1 Transferring Score Data

BGM can be played with the APU by using the SOU\_TRN command to transfer original score data to the prescribed area of APU RAM. The user area is the 8 Kbytes from 0x2B00 to 0x4AFF.

#### 3.2 Summary of BGM Flags

SOUND Command	
0x04 d7-d0 [bit]	
Code	Flag Description
0x00	Dummy flag for retriggering
0x10   0xF	
0x80	BGM stop flag
0xFE	Use prohibited (used by system)
0xFF	Use prohibited (used by system)

**Note** *If 0x01-0x0F are set without score data being transferred, the BGM built into the system is played.*

*This BGM is exclusively for use by the system, so 0x01-0x0F should not be written as a BGM flag without original score data being transferred.*

*Even if original score data is transferred, there is risk that the sound program will run uncontrolled if a non-designated code is written.*

*Muting is in effect when the system is initialized, so the BGM playback settings must be made after muting is canceled.*



### **3.3 Overview of Creating Score Data**

Original BGM can be played with the SGB sound program by transferring score data to the APU using system commands.

Fifty-seven sounds can be used in BGM, and the score data can be up to just under 8 Kbytes in size.

The method used to create a musical piece is nearly identical to that of the standard SNES.

When the NEWS system is used, score data is created using Kankichi-kun. When IS-SOUND is used, score data created by an external sequencer are processed through MIDI and converted to create score data supported by the standard sound driver KAN.ASM.

In addition the SGB score data format has been made openly available, allowing those using original tools to create score data in this format.

In creating musical pieces, please refer to Section 4, *SGB Sound Program Source List*, when selecting sounds. Please do not change the order of these source data.

### **3.4 Setting the NEWS System Working Environment**

*Working Environment Settings for the NEWS System*

1. Rename the current sobox directory.

```
% mv sobox xxxxx
```

2. Create a new sobox directory.

```
% mkdir sobox
```

\* SGB can use only specific sound objects. Thus, special SGB source data must be installed. A sobox directory for SGB use must be created to prevent loss of previously installed source data files with the same names as the data files to be installed.

3. Move to the sobox directory.

4. From the installation disk, install **soread** in this directory.

```
% tar xvf /dev/rfh0a soread
```

5. Next install the sampling data files (xxx.so . . . ) in this directory.

```
% soread
```

Executing the above command causes the sampling data to be automatically installed.

6. Create a new SGB working directory at any location.

```
% mkdir #####
```

7. Move to the SGB working directory.

8. From the installation disk, install the following files in the working directory: **sgbt.asm**, **sample.kan**, **check.kan**, **kankichib.hex**, and **kan.equ**.

```
% tar xvf /dev/rfh0a sgbt.asm sample.kan check.kan kankichib.hex kan.equ
```

\* The organization and address settings in **kankichib.hex** are as shown below.

\* Use the installed **kankichib.hex** file when starting up **mapu**.

Item	Setting
Kan.equ	0x4c30
Kan.tan	0x04c10
Program start address	0x00400
DIR address	0x04b00
Echo end address	0x0ff00
Sound score start address	0x02b00

9. Make the following changes in the file **.cshrc** in the home directory.

--- Following are the Sound Generation Environments Settings ---

	Before Change	After Change
StartOfKan	0x800	0x400
StartOfDirectory	0x3c00	0x4b00
EndOfDirectory	0x3cff	0x4c0f
StartOfAttribute	0x3e00	0x4c30
StartOfTan	0x3f00	0x4c10
StartOfWave	0x4000	0x4db0
EndOfWave	0xcfff	0xeeff
StartOfFumen	0xd000	0x2b00

10. In the home directory, execute the following command: **source .cshrc**.

### *Cautions When Using Kankichi-kun*

1. Copy **sample.kan** to a newly created score data file, **[score\_name].kan**.

```
% cp sample.kan xxx.kan
```

- \* This avoids the task of creating a source list in source-list order when using **mapu**.

2. Start **mapu**.

```
% mapu -k
```

- \* When starting **mapu** for the first time, press the NICE reset button.

3. The usable sounds (sources) can be checked with **mapu**. Selecting **check.kan** allows the sounds to be checked in source-list order.

- \* If data in files such as **check.kan** are changed, the sounds cannot be checked.

4. To actually create a tune, select **xxx.kan**.

- \* Source data (sampling data) that SGB can use have been set in **xxx.kan**. The source list is shown in Section 4, *SGB Sound Program Source List*. Note that changing the order of the source list will result in sounds different from the intended sounds when BGM is played.

5. When producing a musical piece, see Section 3.7, *Cautions Regarding Production of Musical Pieces*. Refer to the Kankichi-kun Manual.

6. Finally, convert to the file format described in Section 3.8, *Format for Transferred Files*.

### 3.5 Setting the Working Environment Using IS-SOUND

#### *Environment Required*

- Hardware: IS-SOUND connected to a host computer
- Software: IS-SOUND software tools (installed)

#### *Revisions*

1. Portions of the IS-SOUND software tool KAN.EQU were revised as indicated below (older versions only).

Before Revisions	After Revisions
cut: equ 122+ 0x80	wav: equ 122+ 0x80
fft: equ 123+ 0x80	sel: equ 123+ 0x80
ply: equ 124+ 0x80	cut: equ 124+ 0x80
wav: equ 125+ 0x80	fft: equ 125+ 0x80
sel: equ 126+ 0x80	ply: equ 126+ 0x80

1. Set Gate Table data to 050 · 101 · 127 · 152 · 178 · 203 · 229 · 252.
2. Set Velocity Table data to 025 · 050 · 076 · 101 · 114 · 127 · 140 · 152 · 165 · 178 · 191 · 203 · 216 · 229 · 242 · 252.

**Note** *Sound data (sampling data) are required to check music data using IS-SOUND. Consequently, a program equivalent to the sound program built into the SGB hardware (including sound-effect data) and sampling data (sound data) have been provided in a hex file for MS-DOS. The following briefly describes how to set up this program and data.*

#### *Setting the Working Environment*

1. Create an SGB working directory at any location, and move to that directory.
2. Copy **sgbsound.hex** from the disk to the working directory.
3. Start the debugger **shvc**.
4. Also start the sound debugger **ssnd**.
5. Execute **r sgbsound.hex** to load **sgbsound.hex**.
6. Execute **g400** to run the sound program.
7. Press the HOME button to switch to shvc mode.
8. Execute **s2140** to write 01 (from the main program, writes 01 to 0 of the sound port).

With this procedure, the pre-loaded source data (sampling data) are played in the order shown in Section 4 of this chapter, *SGB Sound Program Source List*.

After the data is transferred once, only the score data needs to be transferred to allow music to be checked again.

### ***Cautions***

1. Score data is the data defined in KAN.ASM Version 1.21 as being located from GFT onward. For information on all items related to converting data from other sequencers to score data, formats, and tool usage, see the IS-SOUND manual.
2. Set the source data number according to the source list.
3. Set the starting address of the score data to 0x2B00.
4. When producing a musical piece, do so in accordance with Section 3.7, *Cautions Regarding Production of Musical Pieces*.
5. Convert to the file format described in Section 3.8, *Format for Transferred Files*.

### **3.6 Score Data Format When Using Original Tools**

The score data format has been made openly available for the benefit of those using original development tools.

Data that is not in this format will not operate on SGB.

Note that in some cases, program control may be lost.

### ***Score Data***

#### Glossary of Terms

gft	Location of tune table definitions (collection of tune label definitions). Up to 15 tunes can be defined. The order defined here corresponds to the flag set for port 0 (0x01-0x0F).
Tune label	A label name applied to each tune.
Block	A unit several bars long that each tune is divided into.
Parts	The channels that make up each block (maximum of 8 parts).
Performance data	The aggregate of the score data played by the parts. The parts in the channels must all be the same length (number of steps) in a given block.

**Overall Format of Score Data**

## Example 1

\* Area inside dotted frame = Data table for 1 tune

```

    org 02b00H                ; (a) Starting address of score data
    gft:                       ; (b) Tune table
    dw bgm1,bgm2, ...        ; Indicate the tune labels

```

```

    bgm1:                       ; (c) Tune label 1
    dw bgm1_block1           ; (d) Block 01
    bgm1_0:
    dw bgm1_block2           ; (d) Block 02
    dw bgm1_block3           ; (d) Block 03
    dw 255                    ; (e) Repetition code (endless)
    dw bgm1_0                 ; (e) Repetition starting address
    dw 000                    ; (f) Tune label end code
    ;
    bgm1_block1:              ; (g) Block 01
    dw bgm1_block1_0         ; (g) Starting address of Part 0
    dw bgm1_block1_1         ; (g) Starting address of Part 1
    dw bgm1_block1_2         ; (g) Starting address of Part 2
    dw bgm1_block1_3         ; (g) Starting address of Part 3
    dw 00                     ; (g) Part 4 unused
    dw 00                     ; (g) Part 5 unused
    dw 00                     ; (g) Part 6 unused
    dw 00                     ; (g) Part 7 unused
    bgm1_block2:
    . .                       ; (g) Same in Block 2
    . .
    bgm1_block3:
    . .                       ; (g) Same in Block 3
    . .
    bgm1_block1_0:           ; Block 01 (h) Part 0 performance data
    db tp1,049,mv1,200,sno,$1a,pv1,180,pan,010
    db ecv,255,040,040,edl,002,090,002,tun,050
    db 012,P99+V99,c30,d30,e30,f30,024,g30,kyu
    db 00                      ; (h) Part end code
    bgm1_block1_1:           ; (h) Part 1 performance data
    db sno,$1b,pv1,140,pan,008,tun,030
    db 096,P99+V99,g20
    bgm1_block1_2:           ; (h) Part 2 performance data
    db sno,$1b,pv1,140,pan,008,tun,030
    db 096,P99+V99,e20
    bgm1_block1_3:           ; (h) Part 3 performance data
    db sno,$1b,pv1,140,pan,008,tun,030
    db 096,P99+V99,c20

```

**Continued on next page**

```
bgm1_block2_0:          Block 02 (h) Part 0 performance data
db  sno,$1a,pv1,200,pan,012,tun,050
db  .....
db  00
.
bgm1_block3_0:          Block03 (h) Part 0 performance data
db  sno,$1a,pv1,200,pan,012,tun,050
db  .....
db  00
.
```



### *Description of Example 1*

(a) The score data map to memory addresses 0x2B00-0x4AFF in the APU. If this area is exceeded, a portion of the sound program will be destroyed.

(b) gft: is the starting address of the entire tune table.  
dw, bgm1, and bgm2... are the tune labels and the starting addresses of the score data items.

(c) The tune label.  
The order in which the blocks are played is defined following the tune label.  
The dotted frame encloses the data for one tune, bgm1.

(d) Data for each block.

(e) 0x01-0x7F (01-127) is the number of loops (repetitions); 0x82-0xFF (130-255) is an endless loop. If repetition is not needed, set the end code (0x00) instead of a loop code.

(f) Block definition end code.

(g) Location where the parts of each block are indicated and the part labels are defined.

Defines the part labels for parts 0, 1, 2, . . . 7 in ascending order from top to bottom. 0x00 should be written for unused parts. Even if some parts are unused, always define 8 parts.

(h) The performance data for each part.

### *Play Data Overview*

Parameters such as temp, volume, pan, source number, echo, velocity, interval, and sound length are set here.

For specific descriptions, see Section 3.6.4, *Code Summaries*.

First set are the effects parameters – such as main volume, ramp, and echo – for Part 0 of the first block. Once these are set, they need not be set again (for other blocks or parts) as long as they are not changed.

Next the parameters such as part volume, pan, source number, and tuning are set for each part.

Then the sound length, velocity + gate time, and interval are set in that order. Be careful to ensure that sound length is always set first, followed by velocity + gate item, then the interval.

If the next sound is the same as the previous sound, the sound length, velocity, and gate time need not be set again.

Finally, a data end code of 00 is set for Part 0 of each block.

Settings for parts 1-7 are not required.

The lower parts and blocks are set in the same manner.

*Code Summaries*

a) Length Data (step time)

This is the length (step time) to the subsequent sound; it corresponds to the length of the sound envelope. The code corresponding to each sound envelope is shown in the following table. Please use the appropriate code in the settings.

Note Length	Code	Note Length	Code	Note Length	Code
Sixteenth note	6	Dotted eighth note	18	Half note	48
Dotted sixteenth note	9	Quarter note	24	Dotted half note	72
Eighth note	12	Dotted quarter note	36	Whole note	96

**Note** For triplets and thirty-second notes, convert using the above values.

(b) Velocity (volume) + gate time

Velocity expresses the volume as a percentage. Here it can be set to 16 levels using the lower-order 4 bits (d0 – d3).

Gate time expresses as a percentage the length that the sound is actually emitted. It can be set to 8 levels using the higher-order 3 bits (d4 – d6).

Changing these values provides legato and staccato effects.

The following table lists the values defined by the SGB sound driver.

The settings are designated using the codes for the listed velocities (VELOCITY) and gate times (GATE\_TIME).

Symbol	Code	d7	d6	d5	d4	d3	d2	d1	d0	Rate
V10	0x00	x	x	x	x	0	0	0		VELOCITY=010%
V20	0x01	0								VELOCITY=020%
V30	0x02	x	x	x	x	0	0	0		VELOCITY=030%
V40	0x03	1								VELOCITY=040%
V45	0x04	x	x	x	x	0	0	1		VELOCITY=045%
V50	0x05	0								VELOCITY=050%
V55	0x06	x	x	x	x	0	0	1		VELOCITY=055%
V60	0x07	1								VELOCITY=060%
V65	0x08	x	x	x	x	0	1	0		VELOCITY=065%
V70	0x09	0								VELOCITY=070%
V75	0x0A	x	x	x	x	0	1	0		VELOCITY=075%
V80	0x0B	1								VELOCITY=080%
V85	0x0C	x	x	x	x	0	1	1		VELOCITY=085%
V90	0x0D	0								VELOCITY=090%
V95	0x0E	x	x	x	x	0	1	1		VELOCITY=095%
V99	0x0F	1								VELOCITY=099%
P20	0x00	x	0	0	0	x	x	x		GATE_TIME=020%
P40	0x10	x								GATE_TIME=040%
P50	0x20	x	0	0	1	x	x	x		GATE_TIME=050%
P60	0x30	x								GATE_TIME=060%
P70	0x40	x	0	1	0	x	x	x		GATE_TIME=070%
P80	0x50	x								GATE_TIME=080%
P90	0x60	x	0	1	1	x	x	x		GATE_TIME=090%
P99	0x70	x								GATE_TIME=099%

Symbol input example: P99+V99 Code input example: 0x70+ 0x0F

\*When setting score data using symbols, assemble after defining the equal statement according to the table above.

c) Interval Data

Intervals for 6 octaves can be set here.

Depending on the sound, however, high sounds may not be heard.

The following table shows the correspondence between code settings and intervals. Please refer to this table when setting an interval.

\*Interval symbols: 0x01- 0xB50

Codes: 0x81-0xC7 (tie = 0xC8 · rest = 0xC9)

\*When score data is set using symbols, assemble after defining the equals statement.

Octave 0		Octave 1		Octave 2		Octave 3	
Interval	Code	Interval	Code	Interval	Code	Interval	Code
		C10	0x8C	C20	0x98	C30	0xA4
C01	0x81	C11	0x8D	C21	0x99	C31	0xA5
D00	0x82	D10	0x8E	D20	0x9A	D30	0xA6
D01	0x83	D11	0x8F	D21	0x9B	D31	0xA7
E00	0x84	E10	0x90	E20	0x9C	E30	0xA8
F00	0x85	F10	0x91	F20	0x9D	F30	0xA9
F01	0x86	F11	0x92	F21	0x9E	F31	0xAA
G00	0x87	G10	0x93	G20	0x9F	G30	0xAB
G01	0x88	G11	0x94	G21	0xA0	G31	0xAC
A00	0x89	A10	0x95	A20	0xA1	A30	0xAD
A01	0x8A	A11	0x96	A21	0xA2	A31	0xAE
B00	0x8B	B10	0x97	B20	0xA3	B30	0xAF

Octave 4		Octave 5		Misc.		
Interval	Code	Interval	Code	Tie	TIE	0xC8
C40	0xB0	C50	0xBC	Rest	KYU	0xC9
C41	0xB1	C51	0xBD			
D40	0xB2	D50	0xBE			
D41	0xB3	D51	0xBF			
E40	0xB4	E50	0xC0			
F40	0xB5	F50	0xC1			
F41	0xB6	F51	0xC2			
G40	0xB7	G50	0xC3			
G41	0xB8	G51	0xC4			
A40	0xB9	A50	0xC5			
A41	0xBA	A51	0xC6			
B40	0xBB	B50	0xC7			

**Note 1:** A value of 1 in the right-most position of the interval symbol indicates a  $\sharp$ .

A  $\flat$  is represented as the  $\sharp$  of one interval lower.

Example: C01=C $\sharp$  for interval 0.

**Note 2:** When specifying a tie, first set the step time (length) and velocity + gate time. (This can be skipped if unchanged from the previous sound.)

A tie cannot be used at the start of a block.

**Note 3:** When specifying KYU (a rest), first set the step time (length). (This can be skipped if unchanged from the previous sound.)

Settings Example:

db	<u>Length</u> 024,	<u>Gt &amp; Vel</u> P99+V99,	<u>Interval</u> C30	<u>Code</u> ;(0x0A4) for specifying an interval
db	<u>Length</u> 048,	<u>Gt &amp; Vel</u> P90+V95,	<u>Tie</u> TIE	<u>Code</u> ;(0x0C8) for specifying a tie
db	<u>Length</u> 096	<u>Rest</u> KYU		<u>Code</u> ;(0x0C9) for specifying a rest

d) Special Symbols

The special symbols represent special data for implementing a variety of special effects. These include sound change, crescendo, panpot change, vibrato, tremolo, and echo. Each symbol has its own parameters.

The following table lists these special symbols, their parameters, and the valid values for these parameters.

☆ Special Symbols

Summary No. 1

Symbol Code	First Argument (range)	Second Argument(range)	Third Argument (range)	Function
sno (\$E0)	SOURCE NAME 0 ≤ X ≤ 127			Sound change
pan (\$E1)	Pan value 0 ≤ X ≤ 20			Panpot (0=L/20=R/10=C) (10 = default)
pam (\$E2)	No. of steps 1 ≤ X ≤ 255	Pan value 0 ≤ Y ≤ 20		Move panpot (Y takes effect after X steps)
vib (\$E3)	No. of hold steps 0 ≤ X ≤ 255	Rate 1 ≤ Y ≤ 255	Depth 1 ≤ Z ≤ 255	Vibrato (no. of hold steps is the time till vibrato takes effect)
vof (\$E4)				Vibrato off
mv1 (\$E5)	Volume 0 ≤ X ≤ 255			Main volume (192 = Default value)
mv2 (\$E6)	No. of Steps 1 ≤ X ≤ 255	Volume 0 ≤ Y ≤ 255		Move main volume (used for crescendo/decrescendo) (Y takes effect after X steps)
tp1 (\$E7)	Rate 1 ≤ X ≤ 82			Tempo See Note 1.
tp2 (\$E8)	No. of steps 1 ≤ X ≤ 255	Rate 1 ≤ Y ≤ 82		Move tempo (Used for retardando/accelerando) (Y takes effect after X steps)
ktp (\$E9)	Transposition level \$E8 ≤ F ≤ \$FF(- value) \$00 ≤ X ≤ \$18			Main key transpose (1= semitone up/-1= semitone down) – is the two's complement
ptp (\$EA)	Transposition level \$E8 ≤ X ≤ \$FF(- value) \$00 ≤ X ≤ \$18			Part key transpose (1= semitone up/-1= semitone down) – is the two's complement

## ☆ Special Symbols

## Summary No. 2

Symbol Code	First Argument (range)	Second Argument (range)	Third Argument (range)	Function
tre (\$EB)	No. of hold steps $0 \leq X \leq 255$	Rate $1 \leq Y \leq 255$	Depth $1 \leq Z \leq 255$	Tremelo (no. of hold steps is the time till tremelo takes effect)
tof (\$EC)				Tremelo off
pv1 (\$ED)	Volume $0 \leq X \leq 255$			Part volume (192=Default value)
pv2 (\$EE)	No. of steps $1 \leq X \leq 255$	Volume $0 \leq Y \leq 255$		Move part volume (Used for crescendo/decrescendo) (Y takes effect after X steps.)
pat (\$EF)	PAT ADRS(L) $\$00 \leq X \leq \$FF$	PAT ADRS(H) $\$00 \leq Y \leq \$FF$	REPEAT PAT $1 \leq Z \leq 255$	Pattern data subroutine Seen Note 2.
vch (\$F0)	No. of steps $1 \leq X \leq 255$			Vibrato deepens gradually over X number of steps
swk (\$F1)	No. of hold steps $0 \leq X \leq 255$	No. of steps $1 \leq Y \leq 255$	Amount of change $\$DC \leq Z \leq \$FF$ (- value) $\$00 \leq Z \leq \$24$	Start sweep from next sound - is the two's complement
sws (\$F2)	No. of hold steps $0 \leq X \leq 255$	No. of steps $1 \leq Y \leq 255$	Amount of change $\$DC \leq Z \leq \$FF$ (- value) $\$00 \leq Z \leq \$24$	Start sweep heading into next sound - is the two's complement
sof (\$F3)				Sweep off
tun (\$F4)	Amount of change $0 \leq X \leq 255$			Tune (Semitone up with 255)
ecv (\$F5)	ECHO CHANNEL $0 \leq X \leq 255$	ECHO-VOL(L) $0 \leq Y \leq 255$	ECHO-VOL(R) $0 \leq Z \leq 255$	Echo volume Seen Note 3.
eof (\$F6)				Echo off
edl (\$F7)	ECHO TIME $1 \leq X \leq 15$	FEED BACK $\$9D \leq Y \leq \$FF$ (- value) $\$00 \leq Y \leq \$7F$	FILTER No. $0 \leq Z \leq 10$	Echo delay See Note 4. - is the two's complement
ev2 (\$F8)	No. of steps $1 \leq X \leq 255$	ECHO-VOL(L) $0 \leq Y \leq 255$	ECHO-VOL(R) $0 \leq Z \leq 255$	Move echo volume (YZ values take effect after X steps)

Symbol Code	First Argument (range)	Second Argument (range)	Third Argument (range)	Function
swp (\$F9)	No. of hold steps $0 \leq X \leq 255$	No. of steps $1 \leq Y \leq 255$	SWEEP value interval	Sweep (once) The interval takes effect after the specified number of hold steps.

**Note 1:** The tempo values set by the program data and the actual (musical piece) tempos that correspond to those values are as follows.

Please refer to this table to make the conversions.

Music Tempo	Driver Tempo	Music Tempo	Driver Tempo
Quarter note = 400	82	Quarter note = 120	25
Quarter note = 30	62	Quarter note = 60	12
Quarter note = 24	49	Quarter note = 30	6

**Note 2:** Used when the same performance data is repeated (for data compression). Following the pat code, the L and H addresses and the repetition frequency for the performance data is set. The performance data at the addresses specified by pat are then read. The data is played the number of times specified by the repetition frequency. The performance data at the locations specified by pat require an end code of 0x00.

**Note 3:** When applying echo, **ecv** and **edl** are required. The value entered for the echo channel is 1 for echo used in Part 0, 2 for Part 1, 4 for Part 2, 8 for Part 3, 16 for Part 4, 32 for Part 5, 64 for Part 6, and 128 for Part 7. When echo is used for multiple parts, enter the sum of the channel number values.

### *Examples*

When echo is used for parts 0 and 1, the value entered is 3.

When echo is used for all parts, the value entered is 255.

**Note 4:** Echo time is the delay duration. It uses RAM area equal to twice the echo time value, expressed in Kbytes. The echo area in SGB is 4 Kbytes, so a value of 2 or less should be entered. Feedback indicates the amount of delay returned. Filter No. indicates the type of filter applied to the delayed sound.

0 = no filter; 1 = high-pass filter; 2 = low-pass filter; 3 = band-pass filter

\*The symbols marked with a ☆ in the *Special Symbols* table are applied to all parts. These should be set in the first part.

\*When using a symbol to set a special symbol for score data, assemble after defining the equals statement according to the *Special Symbols* table.

\*The special symbols and the arguments that follow should be set in the order shown in the tables.

\*If using IS-SOUND, load **sgbsound.hex** according to the steps in Section 3.5, *Setting the Working Environment for IS-SOUND*. Transferring the subsequently created score data allows the tunes and sounds to be checked.



***Cautions***

1. The starting address for score data should be set to 0x2B00.
2. Source numbers should be set according to the source list.
3. Musical pieces should be produced according to the instructions in Section 3.7, *Cautions Regarding Production of Musical Pieces*.
4. Convert to the file format described in Section 3.8, *Format for Transferred Files*.

***Summary of Play Data Codes***

0x00	Part end code
0x10-0x7F	Note/rest length data & <b>VELOCITY</b> (volume) + <b>GATE_TIME</b>
0x80-0xC7	Interval (sound length) data (C00-B50) * C01-B50 in SGB
0xC8	Tie ( <b>TIE</b> )
0xC9	Rest ( <b>KYU</b> )
0xCA-0xDF	Use prohibited
0xE0-0xF9	Special symbols
0xFA-0xFF	Use prohibited

### 3.7 Cautions Regarding Production of Musical Pieces

The echo parameters set in BGM are applied in the same manner for the A and B sound effects. This is because echo is applied equally to all 8 channels. The parameters have been tuned so that they can also be used with BGM, so please note this when resetting the parameters.

Score Data Settings			
Special Symbol	Echo Channel	Echo Volume L	Echo Volume R
ecv	<u>OOO</u> (Note 1)	40	40
Special Symbol	Echo Time	Feed Back	Filter No.
edl	<u>2</u> (Note 2)	90	2

If echo is not used, specify **e o f** (special symbol) instead of **e c v**.

If a value greater than 2 is specified for **Echo Time**, the sampling data will be destroyed. Up to 15 tunes can be registered (0x01-0x0F). Channels 2 and 3 are allocated for BGM, so these channels should be used for regular playback of BGM parts.

Microtuning of source data used for notes should be specified using the **tun** code with the score data. For tuning values, refer to the recommended tunings in Section 4 of this chapter, *SGB Sound Program Source List* (except for percussion instruments).

The recommended tuning values for this source list are based on an interval of C30 (See Section 3.6.4, *Interval Data*).

Also indicated for each source data item is the score data setting (interval code) for producing sounds with a C30 interval. Please refer to these settings in inputting score data.

In high and low areas, the tuning of some source data may be somewhat off. Whenever this occurs, the tuning value must be modified.

For SGB, all tunings are set 50 cents higher than the standard value (A = 440 Hz).

### 3.8 Format of Transferred Data

#### When Using NEWS

1. Copy **sgbt.asm** to a new transfer file, *filename.asm*.

```
% cp sgbt.asm yyy.asm
```

\* When making transfer files, create them based on **sgbt.asm**.

2. Open **yyy.asm** and modify it as follows.

Line No.	Before Changed	After Changed
113	gft : 02b00H	gft : yyy\$, . . . . .
115	; include xxx.dat	; include yyy.dat . . . . .

\* When adding multiple tunes, add them beginning from line 113. Also increase the number of 'include OOO.dat' statements after line 115 by the number of tunes.

3. Execute the following command: `asm700 yyy.asm`.

The above completes creation of the **yyy.hex** transfer file.

4. Convert the **yyy.hex** file completed in Step 3 to the format used by the SNES sound generator.

Converting to binary data:

```
% cat | h2b -start 400 -b > yyy.bin
```

Converting to hexadecimal data:

```
% cat | h2b -start 400 > OOO.asm
```

#### When Using IS-SOUND or Original Tools

The score data file to be transferred is converted to the format used by the sound boot program.

Example:

```
dw $0030 ; Number of data items to transfer
dw $2b00 ; Transfer destination address
db $00,$01,$02,$03,$04,$05,$06,$07 ; Score data
db $08,$09,$0a,$0b,$0c,$0d,$0e,$0f ; Score data
db $00,$01,$02,$03,$04,$05,$06,$07 ; Score data
db $08,$09,$0a,$0b,$0c,$0d,$0e,$0f ; Score data
db $00,$01,$02,$03,$04,$05,$06,$07 ; Score data
db $00,$01,$02,$03,$04,$05,$06,$07 ; Score data
dw $0000 ; Transfer end code
dw $0400 ; Program start address
```

The number of data items to transfer (2 bytes) and the transfer destination address (2 bytes) are placed at the starting address of the score data. (Be careful to ensure that the data is in this order.) Finally, the transfer end code (2 bytes) and the program starting address are added. (Be careful to ensure that the data is in this order.) The transfer end code is \$0000.

### ***Cautions Regarding Data Transfer***

In SGB, the transfer destination address is \$2b00, and the program starting address is \$0400. Please be sure to use the correct addresses, or program control will be lost.

The area used for the transferred score data is approximately 8 Kbytes. A data overflow will destroy the directory.

If the data exceed 4 Kbytes, divide them into 2 files.

Transfer of score data is completely executed using system commands.

#### 4. SGB SOUND PROGRAM SOURCE LIST

so No.	Kankichi-kun so	so Name	Sound Family	Envelope Type /Specific Sound	Recommended Tuning	Interval
0x000	sn0	+d0.so	Sine Family	Normal envelope		
0x001	sn1	+Dch.so		Envelope with extremely short decay		
0x002	sn2	+d1.so		Electric keyboard envelope		
0x003	sn3	+d2.so		Brass envelope		
0x004	sn4	+d3.so		Pedal organ envelope		
0x005	sn5	+d5.so		Banjo envelope		
0x006	sn6	+d9.so		'Soft' envelope		
0x007	sn7	sin.so		Normal sine wave		
0x008	sn8	+d5.so	Bass Family 1	Banjo envelope	t u n, 0 1 3	
0x009	sn9	+d6.so		Bass envelope	t u n, 0 1 3	
0x00a	s10	+d8.so		Fretless bass envelope	t u n, 0 1 3	
0x00b	s11	B1.so		Bass 1	t u n, 0 1 3	
0x00c	s12	+d5.so	Bass Family 2	Banjo envelope	t u n, 0 2 0	
0x00d	s13	+d6.so		Bass envelope	t u n, 0 2 0	
0x00e	s14	+d9.so		'Soft' envelope	t u n, 0 2 0	
0x00f	s15	B2.so		Bass 2	t u n, 0 2 0	
0x010	s16	+d3.so	Guitar Family	Pedal organ envelope	t u n, 0 4 0	
0x011	s17	+d5.so		Banjo envelope	t u n, 0 4 0	
0x012	s18	+Dch.so		Envelope with extremely short decay	t u n, 0 4 0	
0x013	s19	acg.so		Guitar	t u n, 0 4 0	
0x014	s20	+d1.so	Electric Keyboard Family 1	Electric keyboard envelope		
0x015	s21	+d3.so		Pedal organ envelope		
0x016	s22	ep.so		Electric keyboard 1		
0x017	s23	ep2.so		Electric keyboard 1	t u n, 0 0 3	C 2 0

so No.	Kankichi-kun so No.	so Name	Sound Family	Envelope Type/ Specific Sound	Recommended Tuning	Interval
0x18	s24	+d1.so	Electric Keyboard Family 2	Electric keyboard envelope		
0x019	s25	+d3.so		Pedal organ envelope		
0x01a	s26	epf.so		Electric keyboard, soft type		
0x01b	s27	pipe.so	Organ Family	Pipe organ		
0x01c	s28	+d8.so	Strings Family	Fretless bass envelope	t u n, 0 8 0	C 2 0
0x01d	s29	+d4.so		Strings envelope	t u n, 0 8 0	C 2 0
0x01e	s30	S1.so		Strings	t u n, 0 8 0	C 2 0
0x01f	s31	+d9.so	Chorus Family 1	'Soft' envelope	t u n, 1 7 0	B 0 0
0x020	s32	cho1.so		Chorus 1	t u n, 1 7 0	B 0 0
0x021	s33	+d3.so	Chorus Family 2	Pedal organ envelope	t u n, 1 6 5	B 1 0
0x022	s34	cho2.so		Chorus 2	t u n, 1 6 5	B 1 0
0x023	s35	+Dch.so	Xylophone Family	Xylophone	t u n, 0 5 5	
0x024	s36	+d1.so		Electric keyboard envelope	t u n, 0 5 5	
0x025	s37	+d9.so		'Soft' envelope	t u n, 0 5 5	
0x026	s38	Dxlp.so		Xylophone + looping sound	t u n, 0 5 5	
0x027	s39	+d1.so	Brass Family 1	Electric keyboard envelope		
0x028	s40	brs.so		Brass 1		
0x029	s41	brs8.so	Brass Family 2	Brass 2	t u n, 0 2 0	C 2 0
0x02a	s42	+Dch.so	Trumpet Family	Envelope with extremely short decay	t u n, 0 4 0	C 2 0
0x02b	s43	+d5.so		Banjo envelope	t u n, 0 4 0	C 2 0
0x02c	s44	+d9.so		'Soft' envelope	t u n, 0 4 0	C 2 0
0x02d	s45	tp3.so		Trumpet	t u n, 0 4 0	C 2 0
0x02e	s46	+d4.so	Bassoon Family	Strings envelope		
0x02f	s47	fg.so		Bassoon		
0x030	s48	fl.so	Flute Family	Flute	t u n, 0 5 3	C 2 0

so No.	Kankichi-kun	so Name	Sound Family	Envelope Type Specific Sounds	Recommended Tuning	Interval
0x031	s49	Db.so	Percussion Instrument Family	Bass drum		
0x032	s50	+Dch.so		Closed high-hat		
0x033	s51	Doh.so		Open high-hat		
0x034	s52	sdr3.so		Snare 1		
0x035	s53	Ds.so	Percussion Family	Snare 2		
0x036	s54	Dt.so		Tom (for stepping down)	t u n, 0 1 0	
0x037	s55	clp.so	SE Family	Hand clap		
0x038	s56	jet2.so	SE Family	Jet		
* The following (0x39-0x3E) can be used with Kankichi-kun.						
0x039		jet1.so	Jet			
0x03a		noiz.so	Noise			
0x03b		glas.so	Glass breaking			
0x03c		shot.so	Shot			
0x03d		river.so	River flowing			
0x03e		wind.so	Wind blowing			
		_____	_____			

Settings for source data numbers 0x39-0x3E cannot be specified on Kankichi-kun. These source data can be used only with sound effects. However, they can be set using tools other than Kankichi-kun.

The shaded portions are the basic source data. The other source data items are the basic source data with modified envelopes.

The contents of the source list are also listed in the README file located in the **sobox** directory installed for NEWS.

The recommended tuning values in the source list are based on an interval of C30. (See Section 3.6.4, *Interval Data*.) With high- and low-pass filtering, the tuning of some source data may be somewhat off. Whenever this occurs, the tuning value must be modified.

The interval value is the score data setting (interval code) for producing sounds with a C30 interval. For SGB, all tunings are set 50 cents higher than the standard value (A = 440 Hz). The source data items in the empty areas do not require tuning. (In addition, they can be used without changing the interval).

## 5. TRANSFERRING AUDIO DATA TO THE SCORE AREA

In general, the score area (8 K) is provided for transferring only score data. However, audio data also can be transferred for output. Audio data can be transferred only if the following conditions are met.

- The data must not exceed the score area (8 K).
- The data is not transferred to areas other than the score area (except for the Directory and sod data).

If the data is transferred to other areas, the sound effects used by the system may no longer play or may be altered (strange sounds). Transferring data to other areas may also lead to a loss of program control. Therefore, please be certain to ensure that the above two conditions are met.

### 5.1 Required Data and Procedure for Audio Output

1. Sampling data (multiple data items permitted)
2. Score data (score used to play sampling data)

\* 1 and 2 combined must occupy less than 8 Kbytes.

\* The sound numbers ( so No.) corresponding to the sampling data should be from among one of the following.

002H,003H,004H & 00CH,00DH,00EH & 02AH,02BH,02CH (hex No.)

**Note** *All numbers other than the above are used for system sound effects or music. Therefore, be careful to use only the above numbers.*

3. Directory and sod data corresponding to the sampling data:

\* Directory and sod data are provided for each sound (so No.).

	Start Address	Data Structure	No. of Bytes
Directory	0x4B00	Source start address (L)/(H) · Source loop(end)address(L)/(H)	4 bytes
sod	0x4C30	so No./ adsr(1)/adsr(2)/gain/blk No.(2byte)	6 bytes

When the sound number is 0x000, the directory data comprise 4 bytes beginning at 0x4B00, and the sod data comprise 6 bytes beginning at 0x4C30 (0x000 cannot be used).

Please substitute the directory data and sod data values corresponding to the given sound number.

**Note** *For the sound number, however, be careful not to use any number other those shown in 2. Use of an incorrect number will cause a loss of program control.*

Transferring all of these data and issuing a BGB request will result in audio playback.



## 5.2 Transfer File Example

With sampling data consisting of a single sound with a sound number of 0x002, the **Directory** data would be the 4 bytes beginning at 0x4B08, and the **sod** data would occupy the 6 bytes beginning at 0x4C3C. In this case, ensure that the score data begin at 0x2B00. Starting these data at any location other than 0x2B00 would cause a loss of program control. The sampling data (audio data) should be transferred to the area between 0x2B00 and 0x3AFF.

```

dw      $0004                ; No. of data items to transfer for Directory
dw      $4B08                ; Directory transfer destination address
db      $00,$30,$3F,$30      ; Directory data (4 bytes)
;
dw      $0006                ; No. of data items to transfer for sod
dw      $4C3C                ; Sod transfer destination address
db      $02,$FF,$E0,$B8,$02,$B0 ; Sod data (6 bytes)
;
dw      $0020                ; No. of score data items to transfer
dw      $2B00                ; Score data transfer destination address
db      $00,$01,$02,$03,$04,$05,&06,$07 ; Score data
db      $00,$01,$02,$03,$04,$05,&06,$07 ; Score data
db      $00,$01,$02,$03,$04,$05,&06,$07 ; Score data
db      $00,$01,$02,$03,$04,$05,&06,$07 ; Score data
;
dw      $0040                ; No. of sampling data items to transfer
dw      $3000                ; Sampling data transfer destination address
db      $00,$01,$02,$03,$04,$05,&06,$07 ; Sampling data
db      $00,$01,$02,$03,$04,$05,&06,$07 ; Sampling data
db      $00,$01,$02,$03,$04,$05,&06,$07 ; Sampling data
db      $00,$01,$02,$03,$04,$05,&06,$07 ; Sampling data
db      $00,$01,$02,$03,$04,$05,&06,$07 ; Sampling data
db      $00,$01,$02,$03,$04,$05,&06,$07 ; Sampling data
db      $00,$01,$02,$03,$04,$05,&06,$07 ; Sampling data
db      $00,$01,$02,$03,$04,$05,&06,$07 ; Sampling data
db      $00,$01,$02,$03,$04,$05,&06,$07 ; Sampling data
;
dw      $0000                ; Transfer end code
dw      $0400                ; Program start address

```

When using multiple sampling data items, also transfer the **Directory** and **sod** data specified for each item in Step 2.

**Note**     *Be careful not to rewrite the **Directory** and **sod** data used by the system.*

*THIS PAGE WAS INTENTIONALLY LEFT BLANK*

<b>Chapter 8: Game Boy Memory Controllers (MBC)</b> .....	<b>212</b>
<b>1. MBC1</b> .....	<b>212</b>
1.1 Overview.....	212
1.2 Description of Registers .....	212
1.3 Memory Map.....	214
<b>2. MBC2</b> .....	<b>215</b>
2.1 Overview.....	215
2.2 Description of Registers .....	215
2.3 Memory Map.....	215
2.4 Backup RAM.....	215
<b>3. MBC3</b> .....	<b>216</b>
3.1 Overview.....	216
3.2 Description of Registers .....	216
3.3 Accessing the Clock Counters .....	217
3.4 Memory Map.....	218
3.5 Programming Items to Note.....	219
<b>4. MBC5</b> .....	<b>221</b>
4.1 Overview.....	221
4.2 Registers .....	221
4.3 Memory Map.....	221
4.4 Description of Registers .....	222
4.5 Programming Cautions .....	223
4.6 Examples of MBC5 programs on DMG and CGB .....	224
<b>5. MBC5 (with rumble feature)</b> .....	<b>225</b>
5.1 Overview.....	225
5.2 Registers .....	225
5.3 Memory Map.....	226
5.4 Description of Registers .....	227
5.5 Motor Control .....	228
5.6 Programming Cautions .....	229
5.7 Physical Effects of Vibration on the Body .....	230

## CHAPTER 8: GAME BOY MEMORY CONTROLLERS (MBC)

### 1. MBC1

#### 1.1 Overview

MBC1 is a memory controller that enables the use of 512 Kbits (64 Kbytes) or more of ROM and 256 Kbits (32 Kbytes) of RAM. It can be used as follows.

- ◆ To control up to 4 Mbits of ROM  
When used to control up to 4 Mbits (512 Kbytes) of ROM, MBC1 can control up to 256 Kbits (32 Kbytes) of RAM.
- ◆ To control 8 Mbits or more of ROM  
When MBC1 is used to control up to 8 Mbits (1 MB) or 16 Mbits (2 MB) of ROM, the following conditions apply
  - ◆ When used to control 8 Mbits of ROM  
MBC1 cannot use ROM addresses 0x080000-0x083FFF (Bank 0x20)
  - ◆ When used to control 16 Mbits of ROM  
MBC1 cannot use ROM Addresses  $\left( \begin{array}{l} 0x8000-0x083FFF \text{ (Bank 0x20)} \\ x100000-0x103FFF \text{ (Bank 0x40)} \\ 0x180000-0x183FFF \text{ (Bank 0x60)} \end{array} \right)$

RAM use by MBC1 is restricted to 64 Kbits (8 Kbytes).

#### 1.2 Description of Registers

- ◆ Register 0: RAMCS gate data (serves as write-protection for RAM)  
Write addresses: 0x0000-0x1FFF Write data: 0x0A  
Writing 0x0A to 0x0-0x1FFF causes the CS to be output, allowing access to RAM.
  - ◆ Register 1: ROM bank code  
Write addresses: 0x2000-0x3FFF Write data: 0x01-0x1F  
The ROM bank can be selected.
  - ◆ Register 2: Upper ROM bank code when using 8 Mbits or more of ROM (and register 3 is 0)  
Write addresses: 0x4000-0x5FFF Write data: 0-3  
The upper ROM banks can be selected in 512-Kbyte increments.
    - Write value of 0 selects banks 0x01-0x1F
    - Write value of 1 selects banks 0x21-0x3F
    - Write value of 2 selects banks 0x41-0x5F
    - Write value of 3 selects banks 0x61-0x7F
- : RAM bank code when using 256 Kbits of RAM (and register 3 is 1)  
Write addresses: 0x4000-0x5FFF Write data: 0-3  
The RAM bank can be selected in 8-Kbyte increments.

- ◆ Register 3: ROM/RAM change  
Write addresses: 0x6000-0x7FFF Write Data: 0-1  
Writing 0 causes the register 2 output to control switching of the higher ROM bank.  
Writing 1 causes the register 2 output to control switching of the RAM bank.

### 1.3 Memory Map

- ◆ When Used to Control up to 4 Mbits of ROM

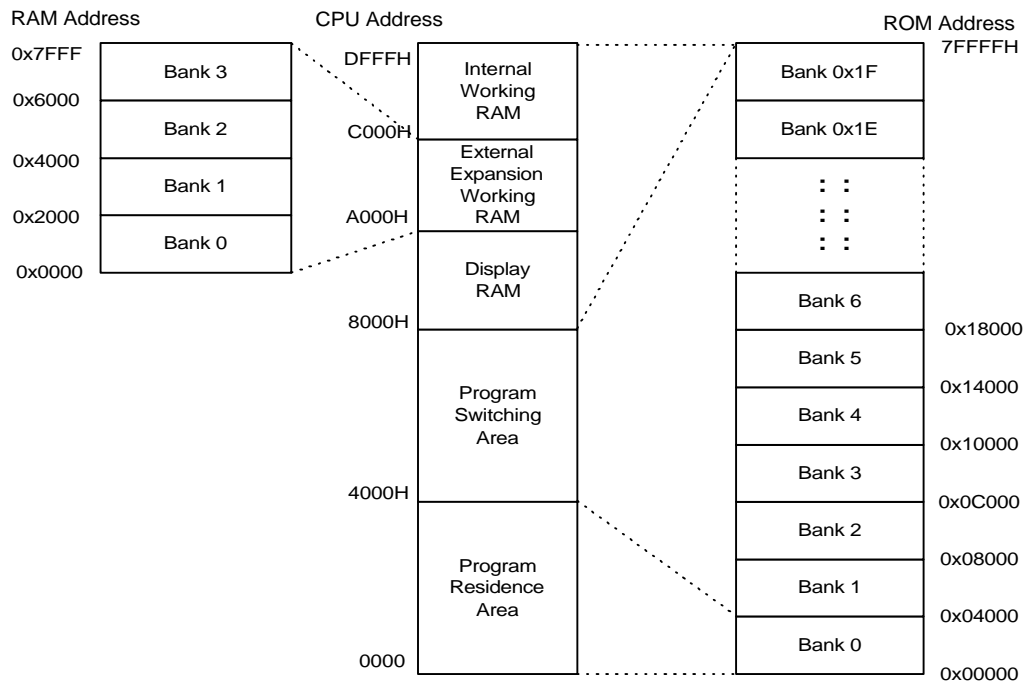

- ◆ When Used to Control up to 8 Mbits of ROM

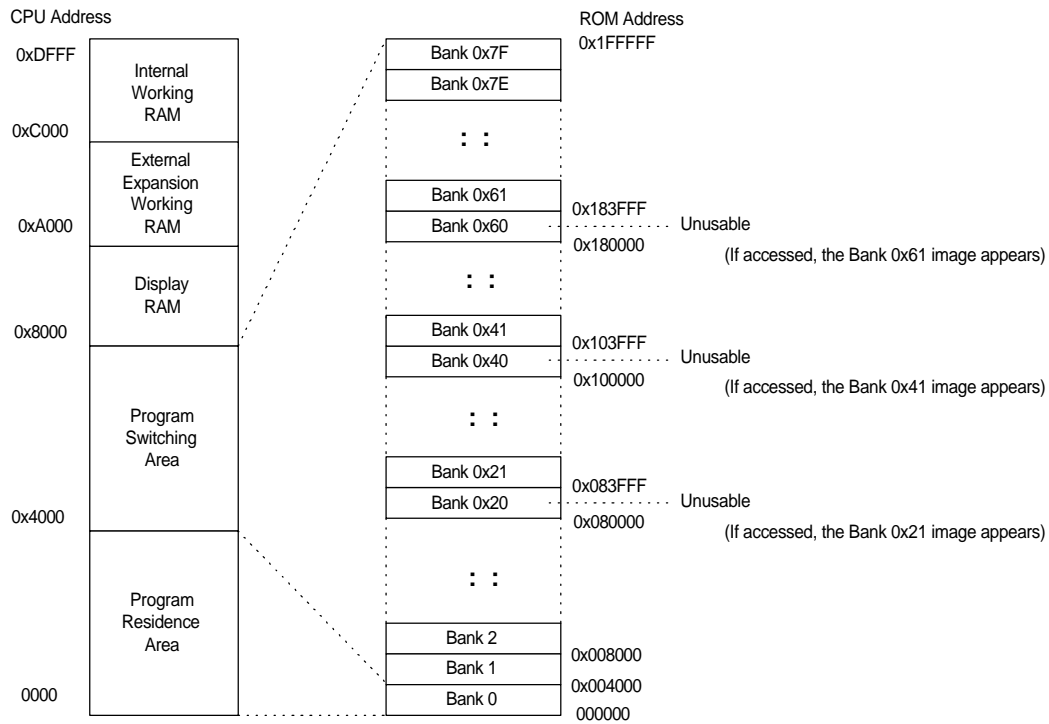

## 2. MBC2

### 2.1 Overview

Controller for up to 2 Mbits (256 Kbytes) of ROM with built-in backup RAM (512 x 4 bits).

### 2.2 Description of Registers

- ◆ Register 0: RAMCS gate data (serves as write-protection for RAM)  
Write addresses: 0x000-0x0FFF Write data: 0x0A  
Writing 0x0A to 000-0x0FFF causes the CS to be output, allowing access to RAM.
- ◆ Register 1: ROM bank code  
Write addresses: 0x2100-0x21FF Write data: 0x01-0x0F  
The ROM bank can be selected.

### 2.3 Memory Map

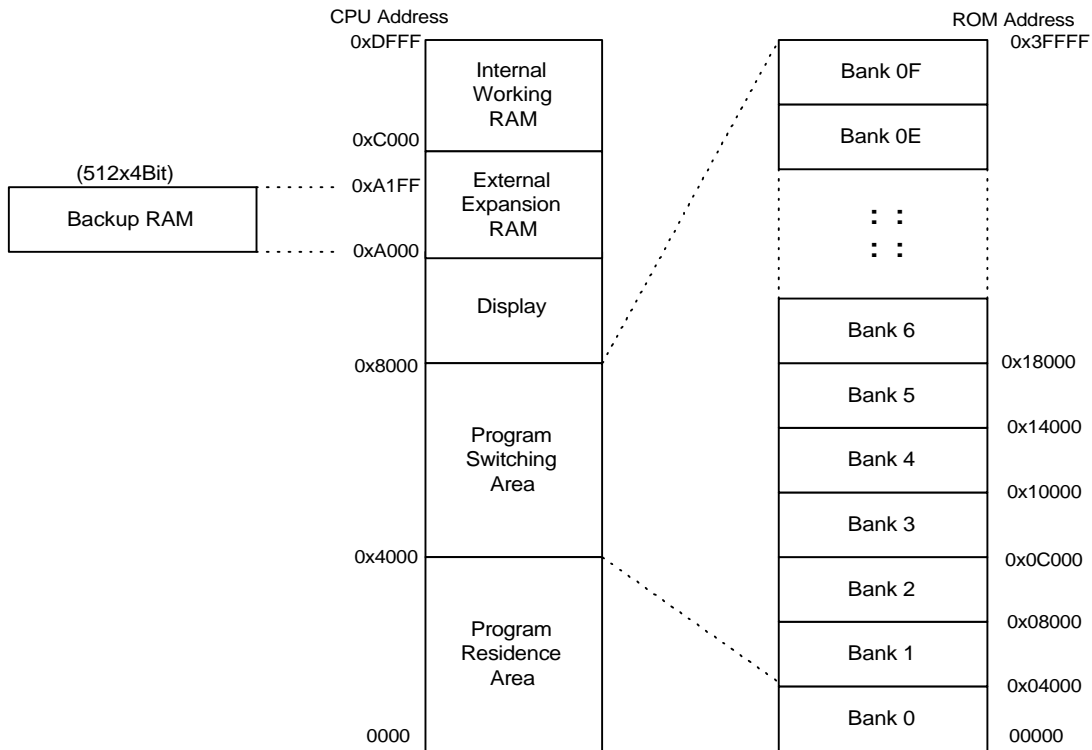

### 2.4 Backup RAM

Allocated to the D0-D3 areas of CPU addresses 0xA000-0xA1FF  
Backup RAM is write-protected by a power-on reset.  
To protect backup data, avoid removing write protection unless necessary.

### 3. MBC3

#### 3.1 Overview

MBC3 is the memory bank controller that allows use of between 512 Kbits (64 Kbytes) and 16 Mbits (2 MB) of ROM and 256 Kbits (32 Kbytes) of RAM.

Built into the controller are clock counters that operate by means of an external crystal oscillator (32.768 KHz). The clock counters are accessed by RAM bank switching.

RAM and clock counter data can be backed up by an external lithium battery.

#### 3.2 Description of Registers

Settings for control registers 0-3 are specified by writing data to the ROM area.

- ◆ Register 0: Write protects RAM and the clock counters (default: 0)  
Write addresses: 0x0000-0x1FFF Write data: 0x0A  
Allows access to RAM and the clock counter registers.
- ◆ Register 1: ROM bank code (default: 0, selects ROM bank 1)  
Write addresses: 0x2000-0x3FFF Write data: 0x01-0x7F  
Allows the ROM bank to be selected in 16-Kbyte increments.
- ◆ Register 2: RAM bank code (default: 0, selects RAM bank 0)  
Write addresses: 0x4000-0x5FFF Write data: 0-3  
Allows the RAM bank to be selected in 8-Kbyte increments.

Write addresses: 0x4000-0x5FFF Write data: 0x08-0x0C  
Allows a clock counter to be selected.

Data	Register	Range of Values	Function
0x08	RTC_S	0-59 (0-0x3B)	Seconds counter (6 bits)
0x09	RTC_M	0-59 (0-0x3B)	Minutes counter (6 bits)
0x0A	RTC_H	0-23 (0-0x17)	Hours counter (5 bits)
0x0B	RTC_DL	0-255 (0-0xFF)	Lower-order 8 bits of days counter
0x0C	RTC_DH	<div style="display: flex; justify-content: space-between;"> <span>bit7</span> <span>bit0</span> </div> <div style="display: flex; align-items: center; justify-content: center;"> <div style="border: 1px solid black; width: 15px; height: 15px; margin-right: 5px;"></div> <div style="border: 1px solid black; width: 15px; height: 15px; margin-right: 5px;"></div> <div style="border: 1px solid black; width: 15px; height: 15px; margin-right: 5px; text-align: center;">0</div> <div style="border: 1px solid black; width: 15px; height: 15px; margin-right: 5px; text-align: center;">0</div> <div style="border: 1px solid black; width: 15px; height: 15px; margin-right: 5px; text-align: center;">0</div> <div style="border: 1px solid black; width: 15px; height: 15px; margin-right: 5px; text-align: center;">0</div> <div style="border: 1px solid black; width: 15px; height: 15px; margin-right: 5px; text-align: center;">0</div> <div style="border: 1px solid black; width: 15px; height: 15px; margin-right: 5px; text-align: center;">0</div> <div style="border: 1px solid black; width: 15px; height: 15px; margin-right: 5px; text-align: center;">0</div> <div style="border: 1px solid black; width: 15px; height: 15px; margin-right: 5px; text-align: center;">0</div> </div>	Higher-order bit and carry bit of days counter.
		Bit 0: Most significant bit of days counter Bit 6: HALT Bit 7: Carry bit of days counter	HALT starts and stops the clock counters.

\* The days counter consists of a 9-bit counter + a carry bit. Thus, it can count from 0 to 511 (0x000-0x1FF).

\* Once the carry bit is set to 1, it remains 1 until 0 is written.

\* The counters operate when HALT is 0 and stop when HALT is 1.

\* Values outside the given counter ranges will not be correctly written.

- ◆ Register 3: Latches the data for all clock counters (default: 0)  
Write addresses: 0x6000-0x7FFF Write Data: 0 → 1  
Writing 0 → 1 causes all counter data to be latched. The latched contents are retained until 0 → 1 is written again.



### 3.3 Accessing the Clock Counters

The clock counter registers are assigned to the external expansion RAM area of the CPU address space. To access the clock counters, RAM bank switching must first be performed.

External expansion RAM Area (0xA000-0xBFFF) Bank Map

Bank	Device	Notes
0x00	RAM BANK 0	
0x01	RAM BANK 1	
0x02	RAM BANK 2	
0x03	RAM BANK 3	
		Not used
0x08	Seconds counter	
0x09	Minutes counter	
0x0A	Hours counter	
0x0B	Days counter (L)	
0x0C	Days counter (H)	
:		Not used

The following are examples of accessing the clock counters.

#### 3.3.1 Reading

The clock counters are accessed by first writing 0x0A to register 0. This opens the gate used to access the counters. To read clock counter values, write 1 to register 3 to latch the values of all the registers. If the value of register 3 is already 1, first set it to 0 and then to 1. While this register is set to 1, the clock counters will operate but the latched values of all of the clock counters will not change. This allows the clock counters to be read.

For example, the seconds counter register can be accessed and read by first setting the RAM bank to 8, then reading from any CPU address between 0xA000 and 0xBFFF.

#### 3.3.2 Writing

Writing 0x0A to register 0 opens the access gate, allowing each clock counter register to be written to.

### 3.4 Memory Map

- ROM bank 0 is assigned to the program residence area (0x0000-0x3FFF) of the CPU memory space (unchangeable).
- One bank from among ROM banks 0x01-0x7F can be assigned to the program switching area (0x4000-0x7FFF) of the CPU memory space.
- One bank from among RAM banks 0-3 and the clock counter registers (RAM banks 0x08-0x0C) can be assigned to the external expansion working RAM area (0xA000-0xBFFF) of the CPU memory space.

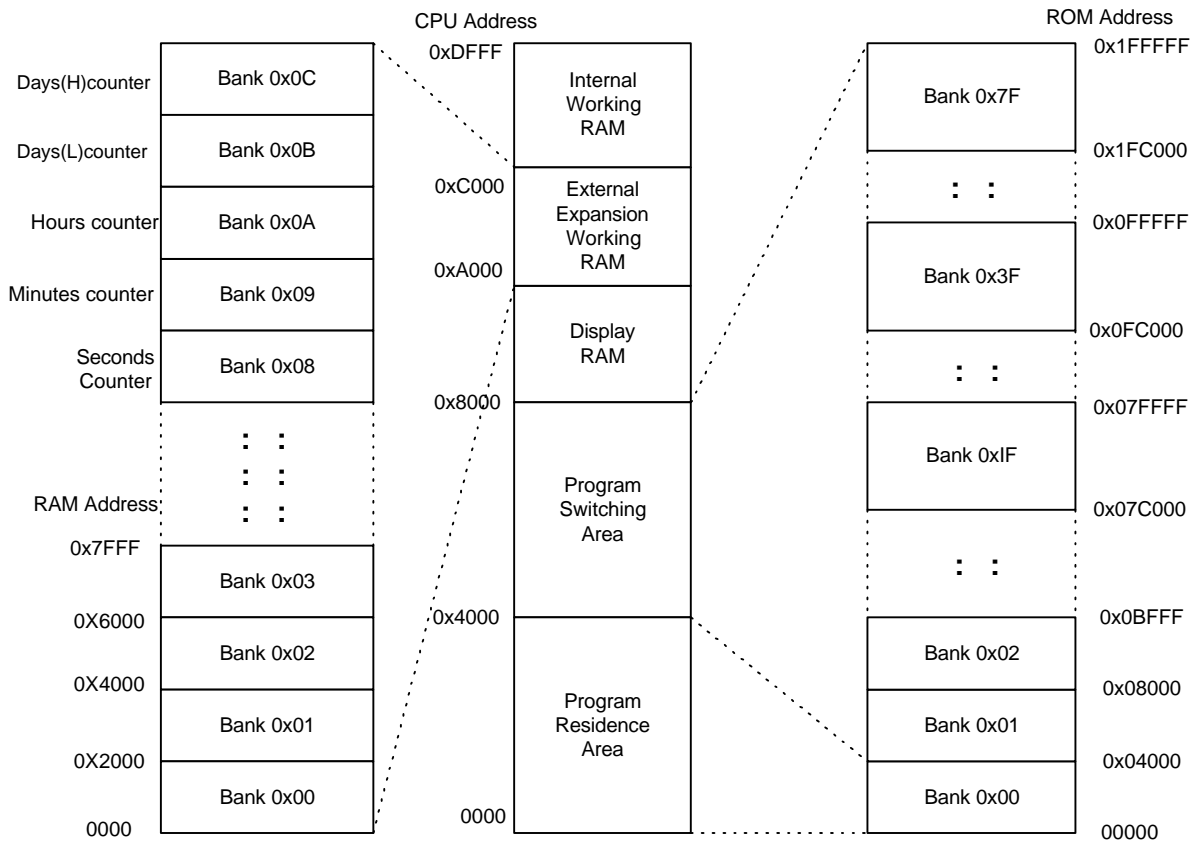

### 3.5 Programming Cautions

#### 3.5.1 Accessing the Clock Counters

Although counting up of the clock counters themselves and accessing the clock counters from the CPU are performed asynchronously, clock counter failure may result if both operations are performed at the same time. To prevent this, MBC3 provides an interface circuit for WR signals from the CPU. Use of this circuit necessitates a delay when accessing control register 3 and the clock counter registers (RTC\_S, RTC\_M, RTC\_H, RTC\_DL, and RTC\_DH). Thus, whenever accessing these registers consecutively, interpose a delay of 4 cycles between accesses.

When reading clock counter data:

- Latch all clock counter data using control register 3.



4-cycle delay required

- Read the data in the clock counter registers.

When writing values to the clock counters:

- Set data in clock counter register RTC\_S.



4-cycle delay required

- Set data in clock counter register RTC\_M.



4-cycle delay required

- Set data in clock counter register RTC\_H.



4-cycle delay required

- Set data in clock counter register RTC\_DL.



4-cycle delay required

- Set data in clock counter register RTC\_DH.

### **3.5.2 Condensation**

MBC3 uses a crystal oscillator for its clock counter operation, and condensation on the oscillator may halt its oscillation, preventing the clocks from counting up. Once the condensation disappears, the clocks will resume counting up from where they stopped. However, please ensure that the counter stoppage does not result in a loss of program control.

### **3.5.3 Control Register Initialization**

Although control registers 0-3 are initialized (see Section 3.2, *Description of Registers*) when Game Boy power is turned on, they are not initialized by a hard reset of SNES when Super Game Boy is used. Therefore, please be sure to implement a software reset of these registers.

### **3.5.4 Clock Counter Registers**

When commercial Game Boy software that uses MBC3 is shipped from the factory, the values of the clock counter registers are undefined. Therefore, please ensure that these registers are initialized.

## 4. MBC5

### 4.1 Overview

Supports CGB double-speed mode.

MBC5 can use up to 64 Mbits of ROM (512 banks of 128 bits each) and 1 Mbit of RAM (16 banks of 64 Kbits each).

Upwardly compatible with MBC1.

### 4.2 Registers

Name	Addresses (hex)
RAMG	0000-1FFF
ROMB 0	2000-2FFF
ROMB 1	3000-3FFF
RAMB	4000-5FFF

### 4.3 Memory Map

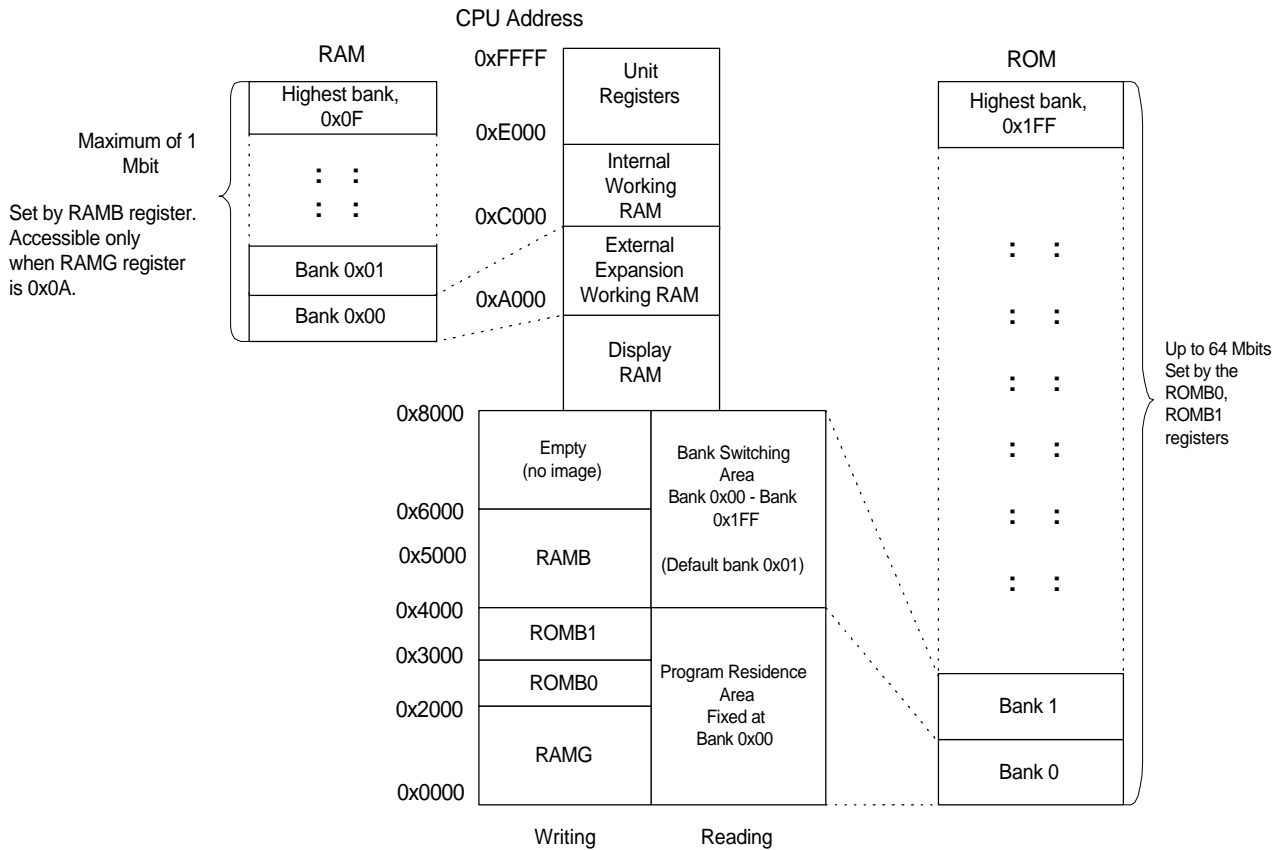

#### 4.4 Description of Registers

◆ Register for Specifying External Expansion Memory (RAMG)

Specifies whether external expansion RAM is accessible. Access to this RAM is enabled by writing 0x0A to the RAMG register space, 0x0000-0x1FFF. Writing any other value to this register disables reading to and writing from RAM.

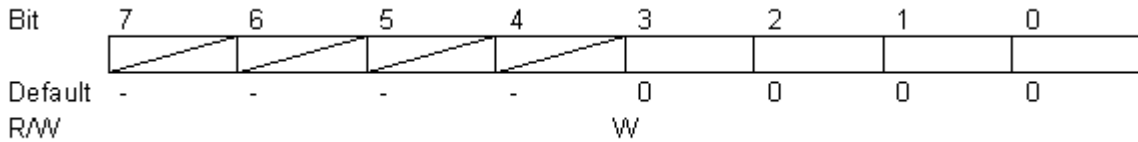

◆ Lower ROM Bank Register (ROMB0)

Specifies the lower-order 8 bits of a 9-bit ROM bank.

The ROM bank can be changed by writing the desired ROM bank number to the ROMB0 register area, 0x2000-0x2FFF.

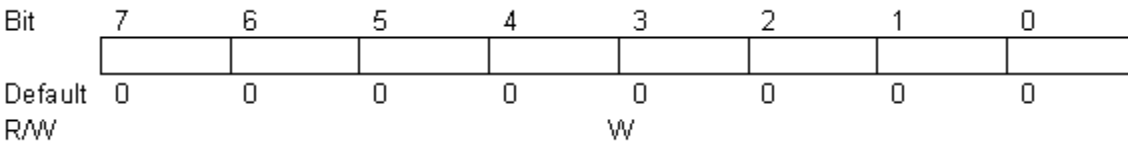

◆ Upper ROM Bank Register (ROMB1)

Specifies the higher-order 1 bit of a 9-bit ROM bank.

The ROM bank can be changed by writing the desired ROM bank number to the ROMB1 register area, 0x3000-0x3FFF.

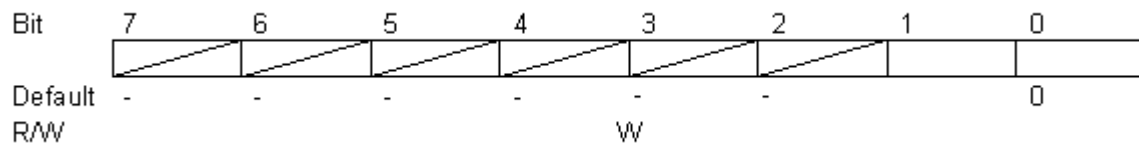

◆ RAM Bank Register (RAMB)

Specifies the RAM bank

The RAM bank can be changed by writing the desired RAM bank number to the RAMB register area, 0x4000-0x5FFF.

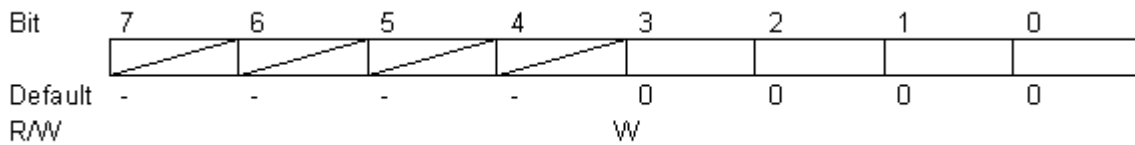

**Note** Although the bits marked with are ignored by MBC5, they should be used after being set to 0. The default values are set automatically when power is turned on.

## 4.5 Programming Cautions

### 4.5.1 When Migrating from MBC1 to MBC5

- ◆ Use of Register 1

If an MBC1 program uses register 1 (ROM bank control register) addresses 0x3000-0x3FFF, the bank intended for selection by ROMB1 in MBC5 will not be selected.

Addresses 0x2000-0x2FFF of register 1 should be used by programs that use MBC1.

- ◆ Use of Register 2

Note that in MBC1, programs that use 8 Mbits or more use register 2 (ROM or RAM bank control register) for the high ROM bank. Consequently, in MBC5 the RAM bank is different while the ROM bank is unchanged.

- ◆ ROM Banks 0x20, 0x40, and 0x60

ROM banks 0x20, 0x40, and 0x60 cannot be used in MBC1, but they can be used in MBC5.

- ◆ MBC1 Register 3 (ROM/RAM change)

Because the addresses of ROM and RAM are independent of each other in MBC5, ROM/RAM switching is unnecessary.

Any write instructions to register3 left in a program that uses MBC1 are ignored by MBC5 and have no effect.

### 4.5.2 General Notes

- ◆ Memory Image

If a memory device is used that uses less than the maximum amount of memory available (ROM: 64 Mbits; RAM: 1 Mbit), a memory image is generated for the empty bank area. Therefore, please do not develop software that uses an image, because it may cause failures.

- ◆ RAM Data Protection

To protect RAM data, it is recommended that RAM access be disabled when RAM is not being accessed (RAMG ← 0x00).

- ◆ Specifying External Sound Input (VIN)

Always use the sound control register (NR50) with bits 7 and 3 (VIN function OFF) set to 0. Because the VIN terminal is used in development flash ROM cartridges, using the register with VIN set to ON will produce sound abnormalities.

#### 4.6 Examples of MBC5 programs on DMG and CGB

- ◆ Set the bank switching area (0x4000-0x7FFF) to 0x1FF.

```
LD A,$FF
LD ($2000),A ;ROMB0 setting
LD A,$01
LD ($3000),A ;ROMB1 setting
|
|
|
```

- ◆ Set the external expansion memory area (0xA000-0xBFFF) to 0x0F.

```
LD A,$0F
LD ($4000),A ; RAMB setting
LD A,$0A
LD ($0000),A ; Enable access to RAM
|
| } RAM Access Processing
|
LD A,$00
LD ($0000), A ; Disable access to RAM
```



## 5. MBC5 (WITH RUMBLE FEATURE)

### 5.1 Overview

This cartridge is the same as the previous MBC5 cartridge but also includes a rumble motor and size AAA battery to power the motor. The motor is controlled by the program using the MBC5 RAM bank register (RAMB, bit 3).

MBC5 supports CGB normal- and double-speed modes.

Up to 64 Mbits (512 banks of 128 Kbits each) of ROM and 256 Kbits of RAM (4 banks of 64 Kbits each) can be used.

### 5.2 Registers

Name	Addresses (hex)	Notes
RAMG	0000-1FFF	Each register executes its control using any one of the address spaces at left.
ROMB 0	2000-2FFF	
ROMB 1	3000-3FFF	
RAMB	4000-5FFF	

### 5.3 Memory Map

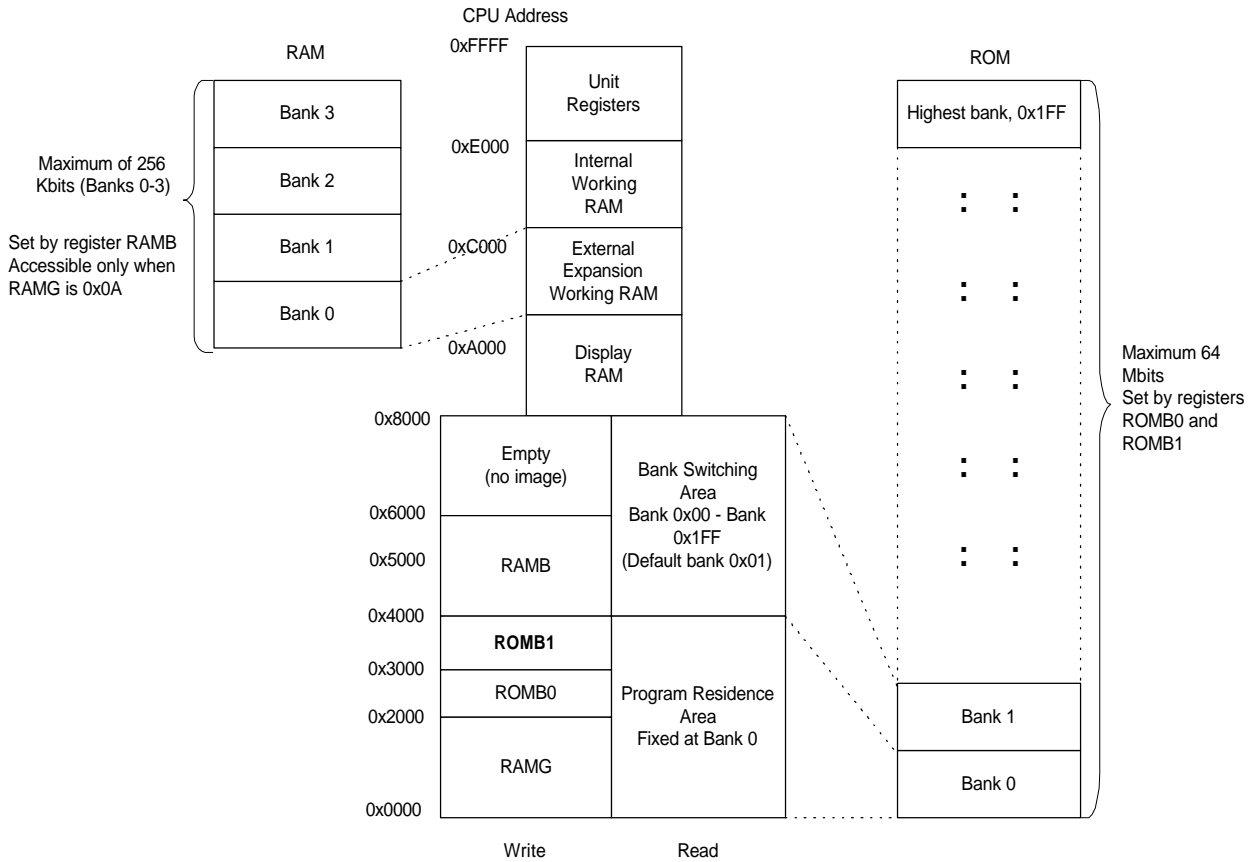

\* During a write, data is written to the bank control registers at CPU addresses 0x0000-0x7FFF. During a read, the contents of ROM are read from these addresses.

### 5.4 Description of Registers

◆ Register for Specifying External Expansion Memory (RAMG)

Specifies whether external expansion RAM is accessible. Access to this RAM is enabled by writing 0x0A to the RAMG register (any single address in 0x0000-0x1FFF). Writing any other value to this register disables reading to and writing from RAM.

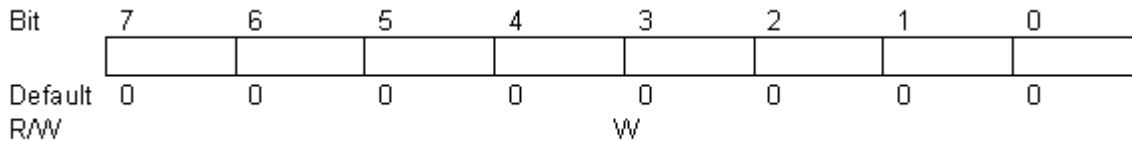

◆ Lower ROM Bank Register (ROMB0)

Specifies the lower-order 8 bits of a 9-bit ROM bank.

The ROM bank can be changed by writing the desired ROM bank number to the ROMB0 register (any single address in 0x2000-0x2FFF).

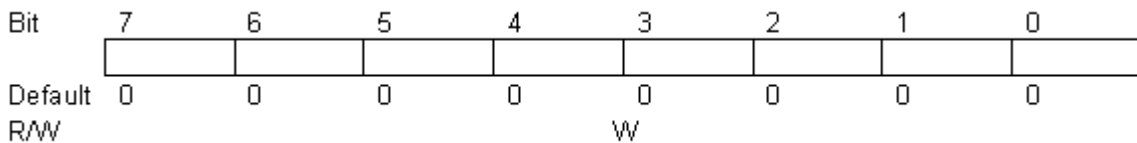

◆ Upper ROM Bank Register (ROMB1)

Specifies the higher-order 1 bit of a 9-bit ROM bank.

The ROM bank can be changed by writing the desired ROM bank number to the ROMB1 register (any single address in 0x3000-0x3FFF).

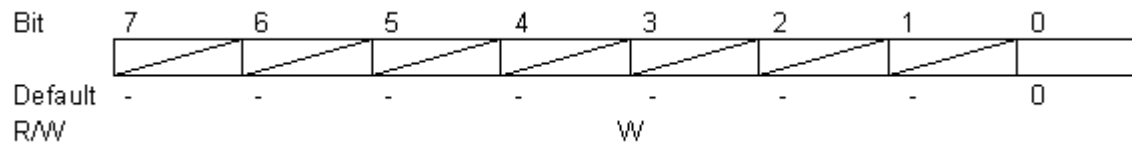

◆ RAM Bank Register (RAMB)

Specifies the RAM bank.

The RAM bank can be changed by writing the desired RAM bank number to the RAMB register (any single address in 0x4000-0x5FFF).

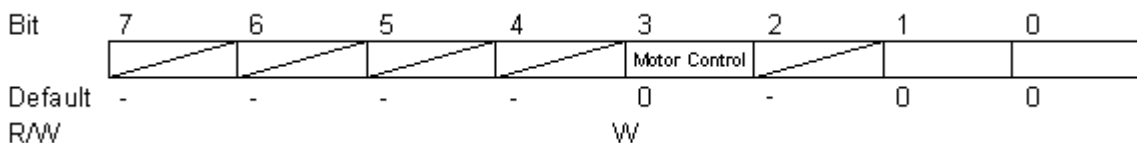

Bits 0-1: Register for RAM bank setting

Bit 3: Motor control register (1: motor ON; 0: motor OFF)

**Note** Be sure to set the bits marked with to 0 before using them. The default values are set automatically when power is turned on.

## 5.5 Motor Control

### 5.5.1 Vibration Level

Control of the rumble motor consists of setting it to ON or OFF.

The vibration level can be controlled by sending pulses of combined ON/OFF instructions in short cycles. Please comply with the following points when implementing vibration control.

(1) Set the frame rate to 1 frame per 1/60 second and control vibration frame by frame.

(2) At the start of vibration control, send a startup pulse (at least 2 ON frames).

A startup pulse also should be sent if the width of an OFF pulse is 3 or more consecutive frames. This is necessary because startup from a complete stop requires a certain amount of time.

(see Ex. 5)

### 5.5.2 Vibration Pulse Examples

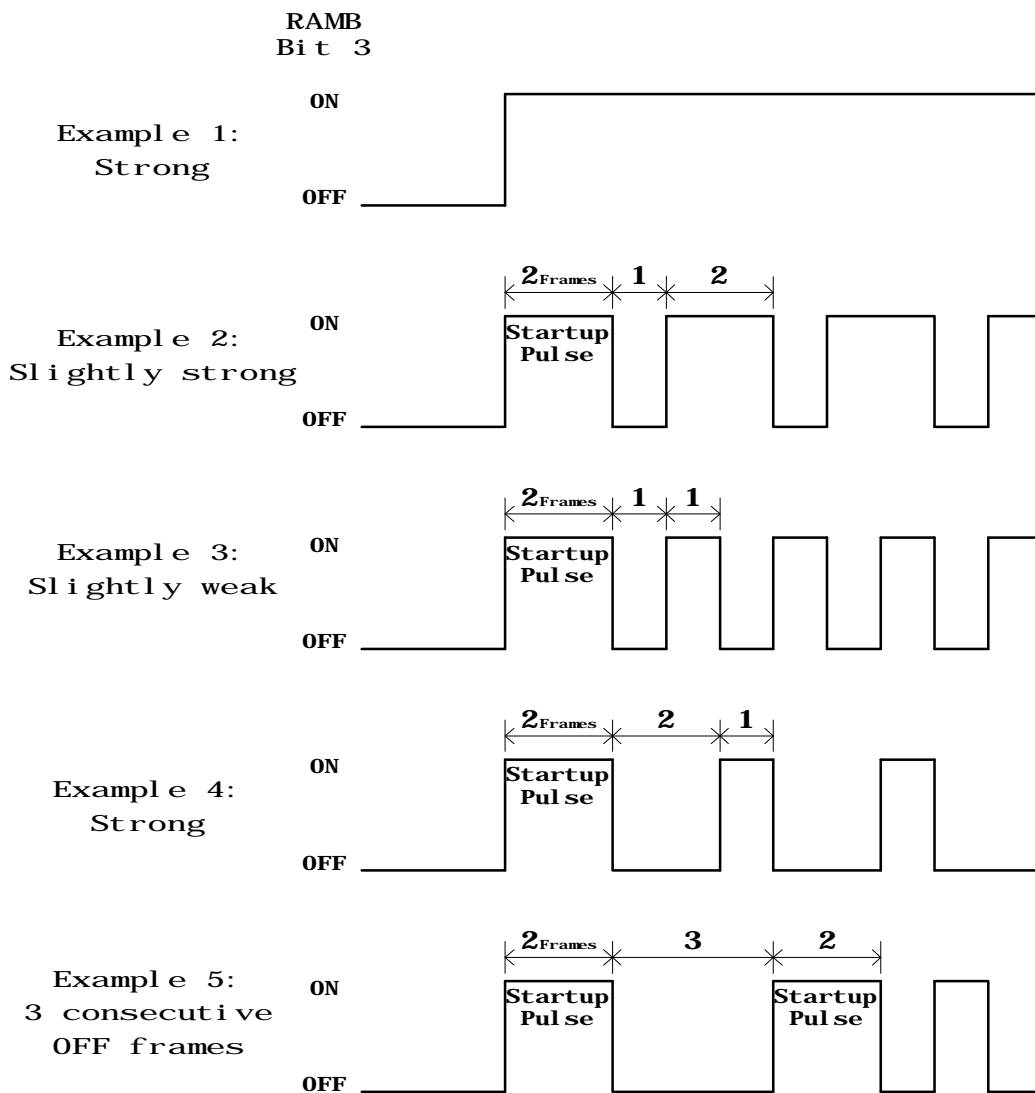

## 5.6 Programming Cautions

### **IMPORTANT**

#### **5.6.1 Memory Image**

If a memory device is used that uses less than the maximum amount of memory available (ROM: 64 Mbits; RAM: 256 Kbits) , an empty bank area (memory image) results. Please do not access this empty bank area. Doing so may result in faulty operation.

#### **5.6.2 RAM Data Protection**

To protect RAM data, it is recommended that RAM access be disabled (RAMG 0x00) when RAM is not being accessed.

#### **5.6.3 Specifying External Sound Input (VIN)**

Always use the sound control register (NR50) with bits 7 and 3 set to 0 (VIN function OFF). Because the VIN terminal is used in development flash ROM cartridges, using the register with VIN set to ON will produce sound abnormalities.

#### **5.6.4 Disabling Vibration Using the SGB, SGB2, or 64GB Pak**

When MBC5 is used by SGB, SGB2, or the 64GB Pak, vibration should be turned off by the program to prevent failures caused by a faulty connection. For methods of recognizing SGB and SGB2, see the description of the MLT\_REQ command in Chapter 6, Section 3.2, *System Command Details*. With the 64GB Pak, vibration is controlled by the N64 software. Therefore, N64 software programs that support MBC5 should not write data to bit 3 of the RAM bank register.

#### **5.6.5 Limiting the Period of Continuous Vibration**

To prevent physical effects in the user such as numbness as a result of continuous vibration, limit the duration of continuous vibration as indicated below, regardless of the vibration strength (see Section 5.5.2, *Vibration Pulse Examples*).

- The duration of continuous vibration should generally be limited to a maximum of 1 minute.
- The period of no vibration between the finish of one period of vibration and the start of the next period generally must be at least as long as the vibration time.

The above points are guidelines that should be followed in most cases. However, if adhering to these guidelines is made difficult by factors such as the game content, take appropriate measures while keeping in mind the points noted in Section 6.7, *Effects of Vibration on the Body*.

#### **5.6.6 Disabling Vibration for Resets and Pauses**

Vibration should be halted during resets and pauses.

When power is turned on, the unit should not be vibrated until some input is received from the controller.

### **5.6.7 Rumble Feature Selection**

The user should be allowed to set the rumble feature to ON or OFF or to select strong, mild, or OFF by means such as an initial-settings screen at the start of the game. In addition, the program should allow the user to easily change these settings even during a game if, for example, they are uncomfortable with the vibration. Such changes also should be allowed a pause.

### **5.6.8 Changes in Vibration Level with Battery Use**

If the battery that powers the motor (Size AAA alkaline battery) wears out, the perceived vibration level will be reduced even if the requested vibration level remains the same.

Therefore, rumble operation should be checked both when the battery is new (1.6 V) and when it is at the end of its life (1.1 V).

## **5.7 Physical Effects of Vibration on the Body**

Users have occasionally experienced numbness for some time after continuous vibration lasting several tens of seconds to several minutes. This may occur regardless of the strength of the vibration (see Section 5.5.2, *Vibration Pulse Examples*).

Unfortunately, the effects of continuous vibration on the body are not yet clear. Thus, the guidelines presented in Section 5.6.5, *Limiting the Period of Continuous Vibration*, are intended to give priority to user safety. However, software development requires free thinking and original ideas, and there may well be cases in which the use of continuous vibration in a game is desirable.

Because each game is different, the limitations presented in Section 5.6.5 are by their nature not restrictions that should be enforced digitally. It is instead preferable for the developer to adequately consider user safety when determining the game's content.

For example, even supposing that continuous vibration does last for more than 1 minute, it may not pose a safety problem if it is used infrequently, such as only when special events occur. Conversely, if vibrations lasting several seconds to several tens of seconds are repeated at short intervals, the effects on the user may be the same as with continuous, long-term vibration.

Thus, the guidelines presented in Section 5.6.5 are not absolute restrictions. However, even if a program varies from these guidelines, the following points should be considered minimum requirements and strictly observed.

- Continuous vibration should not exceed 3 minutes for any reason.
- Because the effects of continuous vibration vary from person to person, the strength of these effects on the user should not be determined independently by the developer. Rather, this determination should be arrived at after considering the opinions of many others during debugging and other phases of development.

<b>Chapter 9: Pocket Printer .....</b>	<b>233</b>
<b>1. Overview.....</b>	<b>233</b>
<b>2. Communication Specifications .....</b>	<b>233</b>
2.1 Bidirectional Communication .....	233
2.2 Transfer Interval for Each Byte.....	233
2.3 Packets and the Transfer Interval.....	233
2.4 Synchronism Check when Connecting .....	233
<b>3. Communication Data Definitions .....</b>	<b>234</b>
3.1 Transferring to the Printer.....	234
3.2 Receiving from the Printer .....	235
3.3 Handling Errors.....	235
<b>4. Packet Details.....</b>	<b>237</b>
4.1 The Initialization and Connection Packet.....	237
4.2 Print Instruction Packet.....	237
4.3 Data Packet.....	238
4.4 Data-End Packet.....	239
4.5 Break Packet.....	239
4.6 NUL Packet.....	239
4.7 Packet Error.....	239
4.8 Other Packets.....	239
<b>5. Printer Status and Packets .....</b>	<b>240</b>
<b>6. Printer Print Sequence .....</b>	<b>241</b>
<b>7. Processing Connection Eval./Preamble Detection Failure.....</b>	<b>242</b>
7.1 Connection Evaluation (includes cable disconnection).....	242
7.2 Preamble Detection Failure.....	242
<b>8. Print Data .....</b>	<b>243</b>
<b>9. Compression Algorithm.....</b>	<b>244</b>
<b>10. Hardware Specifications .....</b>	<b>245</b>
10.1 General Specifications .....	245
10.2 Dimensions and Weight .....	245
<b>11. Miscellaneous.....</b>	<b>245</b>

**11.1 Cautions when Debugging.....245**  
**11.2 Sample Programs Provided by Nintendo (subroutines).....245**



## CHAPTER 9: POCKET PRINTER

### 1. OVERVIEW

These specifications define the serial protocol used to send print and control data from Game Boy to the Pocket Printer (abbreviated to printer). Game Boy sends data to the printer in packets, and the printer responds by returning 2 bytes of status information.

### 2. COMMUNICATION SPECIFICATIONS

#### 2.1 Bidirectional Communication

Serial transfers between Game Boy and the printer are performed in the Game Boy specification communication format (bidirectional).

The shift clock is furnished by the Game Boy. Both Game Boy and the printer start transmission from the most significant bit (MSB).

For more information, see Chapter 1, Section 2.5.1, *Serial Cable Communication*.

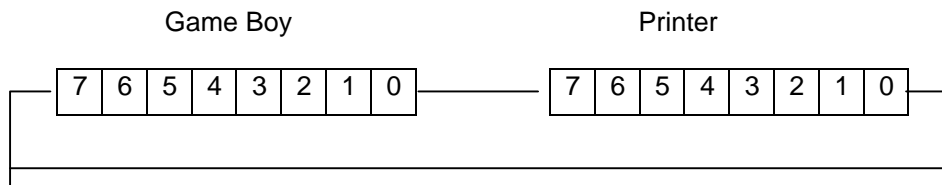

#### 2.2 Transfer Interval For Each Byte

An interval of 270  $\mu$ s to 5 ms must be interposed between each byte sent. Thus, care should be exercised regarding factors like interrupts when programming.

#### 2.3 Packets and the Transfer Interval

Each type of data sent by the Game Boy is sent in a packet. An interval of 270  $\mu$ s to 117 ms must be allowed between the transfer of each packet. Thus, care should be exercised regarding factors like interrupts when programming.

#### 2.4 Synchronism Check when Connecting

After the connection between the Game Boy and printer is confirmed, the Game Boy sends a NUL packet every 100 msec for a synchronism check of the connection. If the Game Boy determines that a connection is unnecessary and does not send a NUL packet in the prescribed time, the printer will determine that the connection is abnormal and will wait in an initialized state for a signal from the Game Boy.

### 3. COMMUNICATION DATA DEFINITIONS

This section defines the following data items (packet types and data) by function.

#### 3.1 Transferring to the Printer

The packet types are as follows.

Packet Type	Code
Initialization and connection packet	01
Print instruction packet	02
Data packet	04
Data end packet	04
Break packet	08
NUL packet	0F

Each of the above packet types is in the following format.

Preamble	Header	Data	Checksum	Dummy
----------	--------	------	----------	-------

- Preamble: 2 bytes of data: 0x88 x 1 + 0x33 x 1. Abbreviated PA below.
- Header: 4 bytes of contiguous data that represent the following.
- Byte 1. Packet type
    - 01: Initialization and connection packet
    - 02: Print instruction packet
    - 04: Data packet
    - 08: Break packet
    - 0F: NUL packet
  - Byte 2: In the case of a data packet, indicates compression/no compression. If another type of packet, fixed at 0x00.
  - Bytes 3 and 4: Data volume (2 bytes), number of bytes of data
- Data: Data in Game Boy character data format. Print instruction data.
- Checksum: 2 bytes of data representing the sum of the header + all data in the data portion of the packet.
- Dummy: 2 bytes of dummy data used to obtain status information from the printer. In the data received from the printer in place of the dummy data, byte 1 holds the peripheral device number and byte 2 holds the printer status.

### 3.2 Receiving from the Printer

The printer returns 2 bytes of status data.

Byte 1: Device number

1	0	0	0	0	0	0	1
---	---	---	---	---	---	---	---

The value of the MSB is always 1. The lower-order 7 bits represent the device number.  
The Pocket Printer is device no. 1.

Byte 2: Status

LowBat	ER2	ER1	ER0	Untran	Full	Busy	Sum
--------	-----	-----	-----	--------	------	------	-----

LowBat: 1 = Low-battery error bit  
0 = Battery OK

ER2: 1 = Other error

ER1: 1 = Paper jam (abnormal motor operation)

ER0: 1 = Packet error

Untran: 1 = Unprocessed data present  
0 = No unprocessed data present

Full: 1 = Image data full  
0 = Image data not full

Busy: 1 = Printer busy  
0 = Printer ready

Sum: 1 = Checksum error  
0 = Data OK

Status information is sent in reply to each 2 bytes of dummy data sent by the Game Boy.

\* The status returned by the printer is FF FF when the printer is not connected to the Game Boy or not powered on.

### 3.3 Handling Errors

Either an error number listed below or the error number plus a description of the error would be sent to the display screen in response to an error flag in byte 2. (This information is also presented in the user's manual of the Pocket Printer. That information must be used together with the information given here.)

Status: Byte 2	Error No.
low Bat = 1	01
FF FF	02
ER1 = 1	03
ER2 = 1	04

\* Error No. 02 is represented using both status bytes.

ER0 = 1 likely indicates program failure.

When an error is generated, always sever communication with the printer and inform the user of the type of error.

A value other than 0x81 for the first status byte means that a device other than the Pocket Printer is connected. This should be conveyed to the user as an error message.

## 4. PACKET DETAILS

### 4.1 The Initialization and Connection Packet

This packet is used to initialize the printer and check the connection. If the Game Boy sends a packet for checking the printer connection and a printer is connected, it returns a 2-byte status code and initializes for the start of print processing. This packet must always be sent when the Game Boy starts to access the printer. It allows transferred data to be invalidated (reset).

#### Actual Data

88	33	01	00	00	00	01	00	00	00
PA		Header				Checksum		Dummy	

This packet has no data section.

Normal status: 0x81 and 0x00 (For more information, see Section 3, *Communication Data Definitions*.)  
 Not connected: 0xFF and 0xFF.

### 4.2 Print Instruction Packet

Used for print instructions for single-sheet mode and copy mode (for specifying the number of sheets).

#### Example

88	33	02	00	04	00	01	13	E4	40	3D	01	00	00
PA		Header				Data				Checksum		Dummy	

Data: Byte 1 specifies the number of sheets. 0-255 (1 in the example). 0 means line feed only.

Data: Byte 2 indicates the number of line feeds. Higher-order 4 bits represents the number of feeds before printing.

Lower-order 4 bits represents the number after printing. Each value is 0x00-0x0F.

\* 1 feed = 2.64 mm

Data: Byte 3 holds the palette values. Default is 00. Palettes are defined by every 2 bits beginning from high bit. (See Chapter 2, Section 2.3, *Character RAM*.)

Data: Byte 4 is the print density adjustment. 0x00-0x7F. Default values are 0x40 and 0x80 or greater.  
 00 < 0x40 < 0x7F  
 -25% 0% +25%

When printing continuous images from multiple screens, setting the number of line feeds to 0 after one screen's worth of data is printed (9 data packets and a data-end packet) enables printing to be continued from one image to the next without a break.

#### Cautions Regarding Print Instructions (**Caution Required**)

- Although applications can print 2-255 pages continuously, this may take a long time. Thus, the user should be provided with a means of halting a print job in progress. (See Section 4.5, *Break Packet*.)
- Whenever possible, the print density data should be backed up to avoid the inconvenience of adjusting the density at each startup.

- If a print instruction packet is set within 100 msec of when the motor is stopped, the position where printing resumes may be incorrect. Always send print instruction packets at least 100 msec after the motor has been stopped.
- Always set the number of line feeds before printing to 1 or greater and the number after printing to 3 or greater, except in the case of the previously mentioned continuous printing, when both values are 0. Other values for these parameters may result in faulty operation, such as double printing on the same line or failure of the last printed line to reach the paper cutter.

**4.3 Data Packet**

Sends print data that are in character data format. The print data is sent in 1-byte increments for the specified number of bytes.

**Example**

88	33	04	00	80	02	Data0 ~ DataN-1	C1	C2	00	00
PA		Header				Data	Checksum		Dummy	

Notification of compression/no compression: Maximum number of data bytes is 0x280 (NoError through 0x3FF): (16 (bytes/color) x 20 (colors) x 2 (colors)).  
 Nine of these packets represent 1 printed sheet. (160 dots x 144 dots)  
 Byte 2 of the header is the compression/no compression notification byte.

- \* 1: Compression (\* upper 4 bits have no effect)
- \* 0: No compression

Transmission of compressed data is accomplished by compressing one line at a time -- each line consisting of 20 characters horizontally and 2 characters vertically -- and sending the number of compressed bytes in order, beginning from the first line.

If the compressed lines exceed 0x280 bytes, the non-compressed data is sent as is (mixture of compressed and non-compressed packets). If the extended data do not fill an entire line when the packets are processed, the printer returns a packet error.

If an instruction to stop printing is received while print data is being sent, an initialization packet can be sent instead of the next data packet.

One Game Boy screen of data is represented by 9 data packets. However, a data-end packet can be sent even if the number of data packets sent is less than 9. In this case, the printer will print only the number of lines received. Line feeds can be performed by sending a data-end packet with no data packet and issuing a print instruction. The printer will then feed the number of lines indicated by the instruction.

Sending the following print instruction packet with a data-end packet but no data packet would specify that 5 sheets be printed, with 1 line feed before printing and 3 line feeds after printing, and that the pre-printing line feeds be ignored. The number of line feeds performed would therefore equal the product of number of sheets to be printed and the number of post-printing line feeds specified. Thus, in this example, the number of line feeds would be 15.

**Example**

88	33	02	00	04	00	05	13	E4	40	42	01	00	00
----	----	----	----	----	----	----	----	----	----	----	----	----	----

#### 4.4 Data-End Packet

##### Actual Data

88	33	04	00	00	00	04	00	00	00
PA		Header				Checksum		Dummy	

This packet has no data section.

A data length of 0 for the data packet header represents the end of the print data. This must always be sent to end print data transmission.

#### 4.5 Break Packet

Used to discontinue printing. The break packet is sent by means of the user's instructions and forcibly stops printing. (Printing is halted after 1 line is printed.)

##### Actual Data

88	33	08	00	00	00	08	00	00	00
PA		Header				Checksum		Dummy	

This packet has no data section.

#### 4.6 NUL Packet

A functionless packet for requesting the current status of the printer. The printer may occasionally be halted unintentionally while printing (e.g., paper jam, low battery), so a NUL packet should always first be sent to check the printer's status.

##### Actual Data

88	33	0F	00	00	00	0F	00	00	00
PA		Header				Checksum		Dummy	

This packet has no data section.

#### 4.7 Packet Error

Except in the case of a checksum error, if a packet of one of these types is sent but does not match the specification described, the printer will return a packet error.

#### 4.8 Other Packets

Packets other than the types mentioned above are ignored by the printer.

## 5. PRINTER STATUS AND PACKETS

The following table shows the packets that can and cannot be sent from the Game Boy to the printer while the printer is in various states.

	Disconnected	Immediately after Connected	Print Buffer Full	While Printing	While Feeding
Connection/initialization packet	O	O	O	▲	▲
Print instruction packet	?	x	O	▲	▲
Data packet	?	O	x	▲	▲
Data-end packet	?	O	x	▲	▲
Break packet	?	▲	▲	O	▲
NUL packet	?	O	O	O	O

O = OK; ▲ = ignored; x = packet error; ? = undefined

\* The user could push the feed button while data is being transferred. In this case, the entire data packet would be ignored, so the same packet would need to be re-sent.



## 6. PRINTER PRINT SEQUENCE

The print sequence used in the Game Boy.

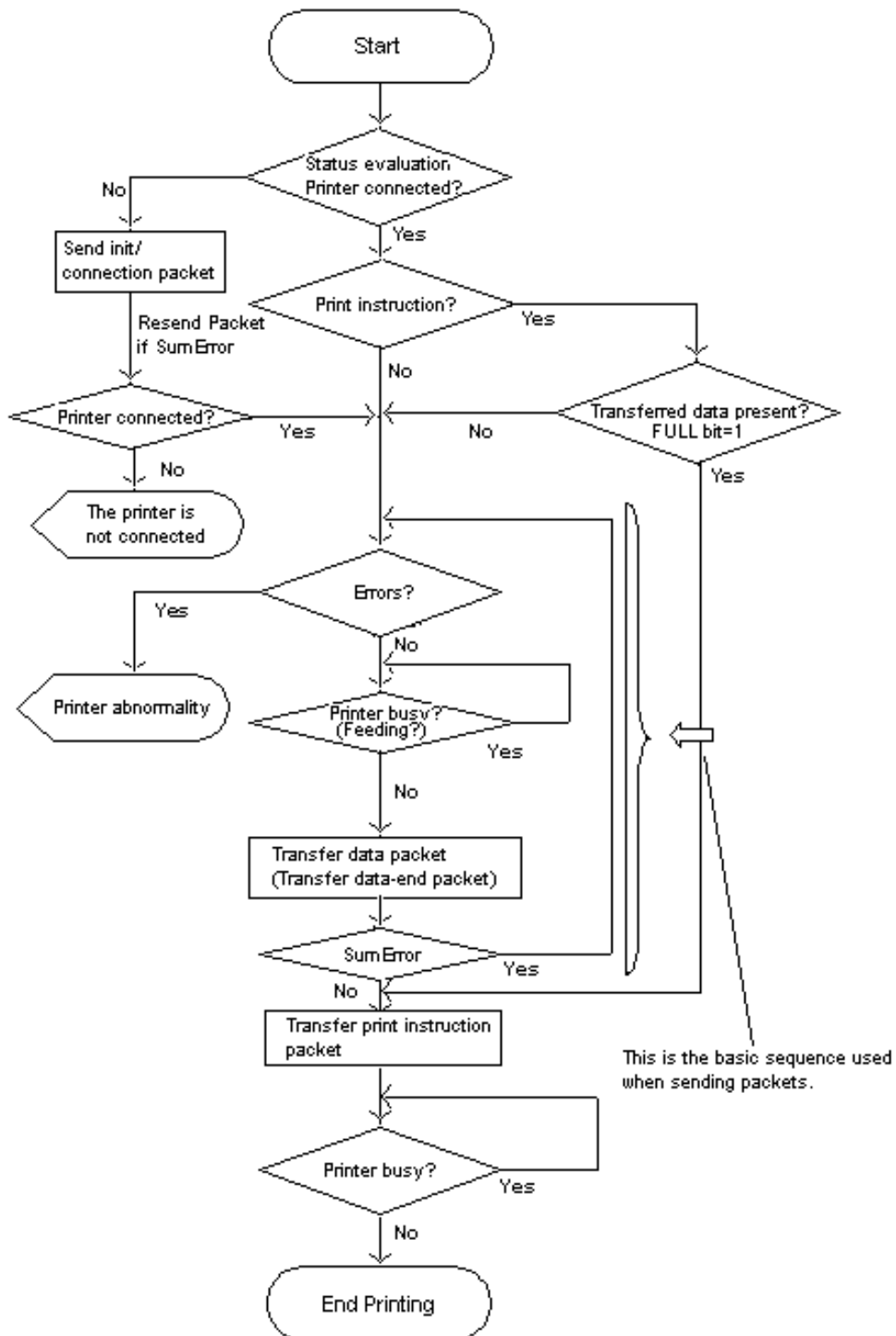

## 7. PROCESSING OF CONNECTION EVALUATION AND PREAMBLE DETECTION FAILURE

### 7.1 Connection Evaluation (includes cable disconnection)

To check whether a printer is connected to the Game Boy, it sends a NUL packet. If nothing is connected, the value 0xFF is received; if there is a connection, 0x00 is received.

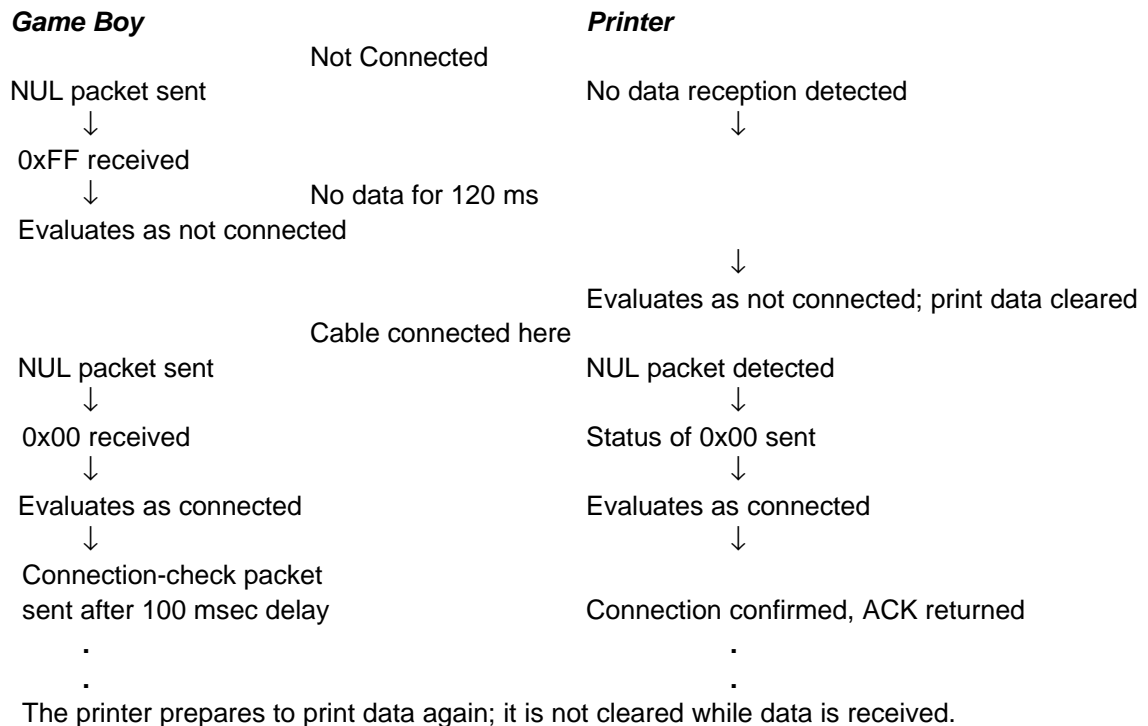

### 7.2 Preamble Detection Failure

If preamble detection fails during data reception, the flow of the Game Boy and printer sequences are as shown below in parallel.

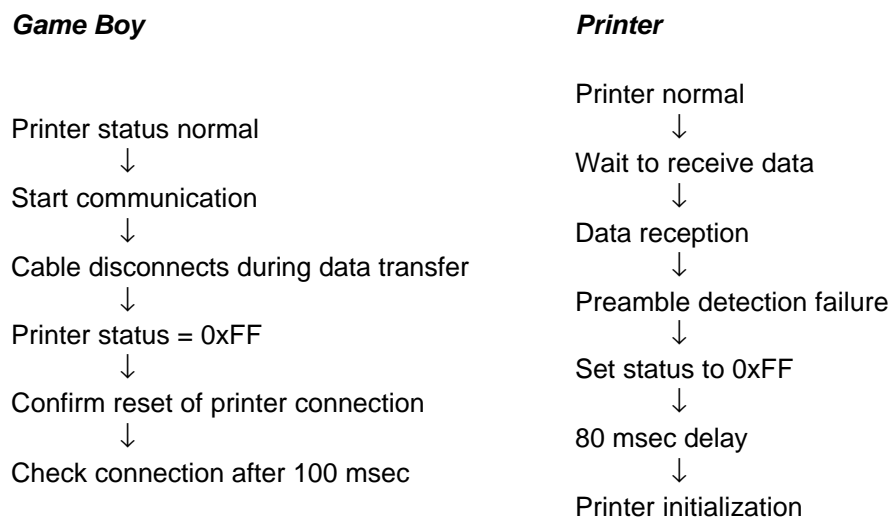

## 8. PRINT DATA

The print data transferred in data packets is in character data format.

### Printing Example

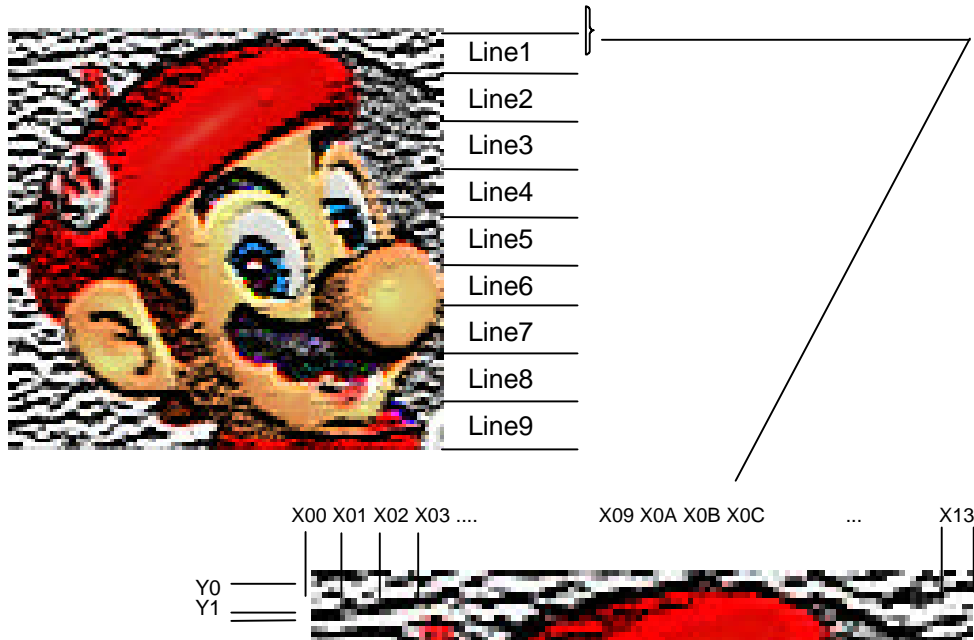

### Transfer Order

Y0.X00 --> Y0.X01 --> Y0.X02 --> ... Y0.X13:	2 x 8 x 20 = 0x140 bytes
Y1.X00 (2 x 8) --> Y1.X01 --> ... Y1.X13:	2 x 8 x 20 = 0x140 bytes
Total	0x280 bytes

1 CHAR =  
 2 bytes (higher grayscale, then lower grayscale) x 8 dots  
 vertically

## 9. COMPRESSION ALGORITHM

Compressed data essentially consist of control codes specifying the data type and length and the actual data.

- ① Control code 1 + raw data
- ② Control code 2 + loop data

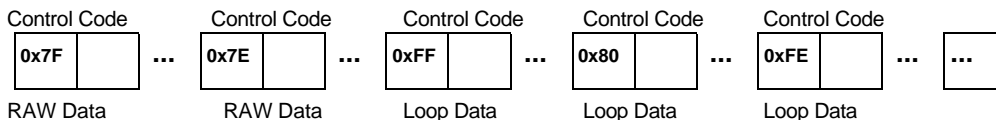

- ① Control code 1 + Raw data  
 0x7F: Next 0x80 bytes are raw data  
 0x0-0x7E (N): Next < N + 1 data items (0x01-0x7F) are raw data

- ② Control code 2 + Loop data  
 0xFF: Repeat the next < 1 byte of data for 0x81 bytes  
 0x80-0xFE: Repeat the next < 1 byte of data for 2 (80) – 0x80 (FE) items

**Example**

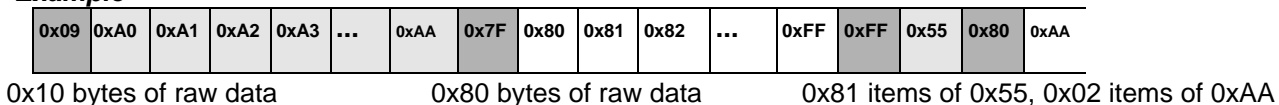

## 10. HARDWARE SPECIFICATIONS

### 10.1 General Specifications

- Printing method: Thermal serial dot
- Print direction: Left to right (facing direction of paper feed)
- Total dot count: 16 x 160 (H x W/line)
- Dot pitch: 0.165 mm x 0.167 mm (H x W)
- Dot dimensions: 0.14 mm x 0.164 mm (H x W)
- Paper feed pitch: 2.64 mm
- Print width: Approximately 6.6 mm
- Printing speed: Approximately 1.1 lines/sec

### 10.2 Dimensions and Weight

- Dimensions: 72.2 mm x 139.5 mm x 56.0 mm (W x D x H)
- Weight: Approximately 190 g (not including battery)

## 11. MISCELLANEOUS

### 11.1 Cautions when Debugging

The printer comes in two types, each made a different manufacturer (Seiko Systems and Hosiden). During final game debugging, the game should be checked with at least 1 printer of each type. The manufacturer can be determined from the serial number on the back of the unit (Printers with PS serial numbers are made by Seiko; those with PH serial numbers are made by Hosiden.) Many of the Seiko printers obtained on the market are the normal Pocket Printer, while many of the printers made by Hosiden are manufactured according to the special Pocket Printer Pikachu Yellow specification. However, depending on the needs of the manufacturers, there is no guarantee that this distinction will hold true in the future. If obtaining a printer proves difficult, please contact Nintendo for a special consultation.

### 11.2 Sample Programs Provided by Nintendo (subroutines)

Modifying a program to suit the intended use is permitted. However, in creating the original program, values for timing and other parameters were calculated to allow normal operation. These parameters must therefore be carefully considered when modifying a program.

***THIS PAGE WAS INTENTIONALLY LEFT BLANK.***

<b>APPENDIX 1: PROGRAMMING CAUTIONS .....</b>	<b>248</b>
<b>1. Using this Appendix.....</b>	<b>248</b>
<b>2. Programming Cautions Regarding Game Boy.....</b>	<b>249</b>
2.1 LCDC/VRAM.....	249
2.2 Communication .....	250
2.3 Sound.....	250
2.4 Miscellaneous Notes.....	251
<b>3. Programming Cautions Regarding MBCs .....</b>	<b>253</b>
3.1 All MBCs .....	253
3.2 MBC 3.....	253
3.3 MBC5.....	254
<b>4. SGB Programming Cautions.....</b>	<b>256</b>
4.1 ROM Data.....	256
4.2 Default Data .....	256
4.3 SOU_TRN default data.....	256
<b>5. Programming Cautions Regarding Pocket Printer.....</b>	<b>257</b>
5.1 Transfer Time Intervals.....	257
5.2 Printing Multiple Sheets Continuously.....	257
5.3 Print Density.....	257
5.4 Operation After the Motor is Stopped .....	257
5.5 Feeds.....	257
5.6 Point of Caution During Debugging .....	257
5.7 Sample Program Provided by Nintendo.....	257
<b>6. Programming Cautions for U.S. Programmers .....</b>	<b>258</b>

## **APPENDIX 1: PROGRAMMING CAUTIONS**

### **1. USING THIS APPENDIX**

#### Purpose and Scope

These programming notes provide information on how to avoid easily made mistakes during program development, information on unique Game Boy programming issues that require special attention, and special issues regarding peripheral devices.

#### Items Covered in this Manual

Many of the topics covered in this appendix also are covered elsewhere in different chapters of this manual. This appendix consolidates the discussion of these topics. Topics that would be more easily comprehensible to the reader when presented separately will also be discussed in another chapter, even though this may duplicate the discussion in this appendix.

**Note:** Although these notes were created to make every effort to eliminate potential sources of trouble at market, they do not represent a guarantee that various potential problems on the market can be absolutely avoided.



## 2. PROGRAMMING CAUTIONS REGARDING GAME BOY

Covers:

DMG: DMG, MGB, and MGL

SGB: SGB and SGB2

CGB: CGB

### 2.1 LCDC/VRAM

#### 2.1.1 Setting the LCDC to OFF (Recommended)

Covers: DMG and CGB

In early DMGs, a black horizontal line appears on the screen if the LCDC is stopped (LCDC register bit 7 ← 0) at any time other than during vertical blanking. Therefore, the LCDC should be set to OFF during V-blanking. If the occurrence of V-blanking cannot be confirmed, the LCDC should be set to OFF when the value of the LY register is 145 (0x91) or greater. These restrictions do not apply in CGB. Thus, when creating software for use on CGB only, the timing of setting the LCDC to OFF need not be considered.

#### 2.1.2 Window x-coordinate Register (Required)

Covers: DMG, SGB, and CGB

When the window is displayed, the window x-coordinate register (register WX, address 0xFF4B) must be set in the range 7-165. A setting of 0-6 or 166 is prohibited. Specifying a value of 167 or greater causes the window not to be displayed.

#### 2.1.3 Displaying Multiple Windows (Required)

Covers: CGB

Multiple windows that divide the screen horizontally into upper and lower areas can be displayed by setting the window x-coordinate register (WX) to a value of 167 or greater during a horizontal blanking period. Attempting to display multiple windows by switching the window ON and OFF during H-blanking may result in the lower window not being displayed.

Display Data		WX Value
Window		WX=7
BG (Background)		$167 \leq WX \leq 255$
Window		WX=7

LCD Display Screen

Display Data		Window
Window		ON
BG (Background)		OFF
Window		ON

LCD Display Screen

**Reference Notes:**

1. Accessing VRAM Outside of a V-blanking period  
In early DMGs, accessing VRAM outside of a V-blanking period would corrupt the screen.
2. Length of H-blanking  
The length of the H-blanking period changes depending on the conditions of OBJ use, so caution is recommended when using H-blanking.

**2.2 Communication**

**2.2.1 Communication Rate (Required)**

Covers: DMG, SGB2, and CGB

Data may be corrupted if the data transfer rate is too high.

The maximum external clock setting should be 512KHz between CGBs.

It should be 500KHz for others including DMG and SGB2.

Also, it should be 256KHz for communication between CGB and DMG.

**2.2.2 Communication Errors (Recommended)**

Covers: DMG, SGB2, and CGB

When using the communication function (infrared), the communicating data may be corrupted by noise and such. Therefore, the program should not go out of control by such data corruption on both the sending and receiving side.

When using the communication function (serial), depending on how program is made, it is confirmed that communication errors happen rarely.

SIO interrupt processing may be delayed by factors such as the processing of other interrupts. This type of error should be avoided by establishing a proper communication interval that allows a problem-free exchange of data.

**2.2.3 Effects of Other Infrared Devices (Recommended)**

Covers: CGB

Adequate care should be taken to ensure against faulty operation and loss of program control even when infrared communication signal input is received from other game software and devices. Note that such problems may particularly occur in communication between multiple games that use the same subroutines. (Before performing data communication, use means such exchanging a unique key code to check whether the same game is on the other hardware.)

**2.3 Sound**

**2.3.1 Using Sounds 1, 2, and 3 (Required)**

Covers: CGB

With continuous operation mode selected (bit 6 of NR\*4 set to 0) for sounds 1, 2, and 3, if the higher-order frequency data (lower-order 3 bits of NR\*4) are changed, the sound length (bits 0-5 of NR\*1) must to set to 0 after the frequency data is set. If the sound length is not set to 0, the sound may stop during playback.

**2.3.2 Using Sound 3 (Required)**

Covers: DMG, SGB, and CGB

When sound 3 is used, data should always first be specified for addresses 0xFF30-0xFF3F of waveform RAM. If the initial flag is set during sound 3 operation (sound 3 ON flag = 1), the contents of waveform RAM will be destroyed.

## 2.4 Miscellaneous Notes

### 2.4.1 Using Interrupts (Required)

Covers: DMG, SGB, and CGB

When interrupts are used, the IF register should be cleared before the IE register is set. If the IF register is not first cleared, an interrupt may be generated immediately after interrupts are enabled.

### 2.4.2 Reading Keys (Required)

Covers: DMG

An interval of approximately 18 cycles should be used between output from P14 and P15 and reading of input. Without this interval, normal key input cannot be read.

### 2.4.3 Using the Timer (Required)

Covers: DMG, SGB, and CGB

The timer should be started (TAC start flag set) after the count-up pulse is selected. Starting the timer before or at the same time as the pulse is selected may result in an extra count-up operation at the time of pulse selection.

Example:

```
LD  A,3      ;Selects f/256 as the count-up pulse.
LD  (07),A   ;Sets TAC ← 3
LD  A,7      ;Starts the timer
LD  (07),A
```

If a write instruction is executed for the modulo register TMA with the same timing as the contents of that register are transferred to TIMA as a result of a timer overflow, the same write data also will be transferred to TIMA..

### 2.4.4 Using STOP Mode (Required)

Covers: DMG, SGB, and CGB

When STOP mode is used, all interrupt-enable (IE) flags should be reset before execution of a STOP instruction. Otherwise, if an interrupt is generated during the period of oscillation stabilization (HALT mode) following STOP mode cancellation, HALT mode will immediately be canceled, preventing a stable system clock from being provided.

### 2.4.5 Using Paired Registers (Required)

Covers: DMG, SGB, and CGB

With instructions that use paired registers BC, DE, and HL, such as the following, there is some chance that OAM RAM may be destroyed. Therefore, ensure that these paired registers are not set to a value in the range 0xFE00-0xFE9E.

```
INC  ss      ; ss : BC, DE, HL
DEC  ss
LD   A,(HLI)
LD   A,(HLD)
LD   (HLI),A
LD   (HLD),A
```

### 2.4.6 Using the HALT Instruction (Required)

Covers: DMG, SGB, and CGB

When using a HALT instruction, always add an NOP instruction immediately after the HALT instruction. Not adding the NOP instruction may in rare cases cause the instruction after the HALT instruction not to be executed.

#### **2.4.7 Switching the CPU Operating Speed (Recommended)**

Covers: CGB

When switching the CPU operating speed, first confirm the current speed by checking the speed flag (bit 7 of register KEY1). In double-speed mode, both the divider (DIV) and timer (TIMA) registers will also be set for double-speed operation.

#### **2.4.8 Using Horizontal Blanking DMA (Required)**

Horizontal blanking DMA should always be started (bit 7 of HDMA5 set to 1) when the STAT mode is not set to 00. If horizontal blanking DMA is started when STAT mode is 00, depending on the timing, the data in LCD display RAM may be destroyed. In addition, execution of a HALT instruction during horizontal blanking DMA may prevent normal cancellation of the HALT mode or DMA. Therefore, HALT instructions should not be used while horizontal blanking DMA is being started.

#### **2.4.9 Using General-Purpose DMA (Required)**

General-purpose DMA should be started (bit 7 of HDMA5 set to 0) with the LCDC off or during V-blanking. However, when transferring data during V-blanking, ensure that the transfer period does not overlap with STAT modes 10 or 11.

#### **2.4.10 DMA Transfers to OAM (Required)**

In DMG and in CGB in DMG mode, when transferring data to OAM by DMA, the user program area (0x00-0x7FFF) should not be used as the starting address of the transfer. In some cases, data cannot be transferred from the user program area normally. CGB mode, however, does enable DMA transfers from the user program area.

#### **2.4.11 Status Interrupts (Required)**

Covers: DMG, SGB, and CGB

When using a status interrupt in DMG or in CGB in DMG mode, register IF should be set to 0 after the value of the STAT register is set. (In DMG, setting the STAT register value changes the value of the IF register, and an interrupt is generated at the same time as interrupts are enabled.)

#### **2.4.12 Chattering (Recommended)**

Covers: DMG, SGB, and CGB

To prevent buttons from inadvertently being pressed twice, an interval should be provided between key reads. (Although this varies with the software, keys are normally read approximately once per frame.)

### 3. PROGRAMMING CAUTIONS REGARDING MBCS

#### 3.1 All MBCs

##### 3.1.1 Protecting RAM Data (Recommended)

To protect RAM data, access to RAM should be disabled (RAMG←0x00) when it is not being accessed.

#### 3.2 MBC3

##### 3.2.1 Accessing the Clock Counters (Required)

If the clock counters themselves are counted up, accessing of the clock counters by the CPU is performed asynchronously. However, if these operations are performed simultaneously, the clock counters may fail. To prevent this, MBC3 provides an interface circuit for WR signals from the CPR. Use of this circuit necessitates a delay when accessing control register 3 and the clock counter registers (RTC\_S, RTC\_M, RTC\_H, RTC\_DL, and RTC\_DH). Thus, whenever accessing these registers consecutively, interpose a delay of 4 cycles between accesses.

*When reading clock counter data:*

- Latch all clock counter data using control register 3.



4-cycle delay required

- Read the data in the clock counter registers.

*When writing values to the clock counters:*

- Set data in clock counter register RTC\_S.



4-cycle delay required

- Set data in clock counter register RTC\_M.



4-cycle delay required

- Set data in clock counter register RTC\_H.



4-cycle delay required

- Set data in clock counter register RTC\_DL.



4-cycle delay required

- Set data in clock counter register RTC\_DH.

##### 3.2.2 Condensation (Required)

MBC3 uses a crystal oscillator for its clock counter operation, and condensation on the oscillator may halt its oscillation, preventing the clocks from counting up. Once the condensation disappears, the clocks will resume counting up from where they stopped. However, please ensure that the counter stoppage does not result in a loss of program control.

### **3.2.3 Control Register Initialization (Required)**

Although control registers 0-3 are initialized (see Section 3.2, *Description of Registers*) when the Game Boy power is turned on, they are not initialized by a hard reset of SNES when Super Game Boy is used. Therefore, please be sure to implement a software reset of these registers.

### **3.2.4 Clock Counter Registers (Required)**

When commercial GB software that use MBC3 are shipped from the factory, the values of the clock counter registers are undefined. Therefore, please ensure that these registers are initialized.

## **3.3 MBC5**

### **3.3.1 Memory Image (Required)**

If a memory device is used that uses less than the maximum amount of memory available (ROM: 64 Mbits; RAM: 1 Mbit), a memory image is generated for the empty bank area. Therefore, please do not develop software that uses an image, because it may cause failures.

### **3.3.2 Specifying External Sound Input (VIN) (Required)**

Always use the sound control register (NR50) with bits 7 and 3 (VIN function OFF) set to 0. Because the VIN terminal is used in development flash ROM cartridges, using the register with VIN set to ON will produce sound abnormalities.

### **3.3.3 Disabling Vibration Using the SGB, SGB2, or 64GB Pak (Recommended)**

When MBC5 with rumble feature is used by SGB, SGB2, or the 64GB Pak, vibration should be turned off by the program to prevent failures caused by a faulty connection. For methods of recognizing SGB and SGB2, see Chapter 6, section 4.2, Recognizing SGB. With the 64GB Pak, vibration is controlled by the N64 software. Therefore, N64 software programs that support MBC5 should not write data to bit 3 of the RAM bank register.

### **3.3.4 Disabling Vibrations for Resets and Pauses (Recommended)**

Vibration should be halted during resets and pauses.

When power is turned on, the hardware should not be vibrated until some input is received from the controller.

### **3.3.5 Limiting the Period of Continuous Vibration (Recommended)**

To prevent physical effects in the user such as numbness as a result of continuous vibration, limit the duration of continuous vibration as indicated below, regardless of the vibration strength.

- Limit the duration of continuous vibration to 1 minute.
- If the nature of the game makes longer periods of continuous vibration unavoidable, limit these periods to 3 minutes.

### **3.3.6 Rumble Feature Selection (Recommended)**

The user should be allowed to set the rumble feature to ON or OFF or to select strong, mild, or OFF by means such as an initial-settings screen at the start of the game. In addition, the program should allow the user to easily change these settings even during a game if, for example, they are uncomfortable with the vibration. Such changes also should be allowed a pause.

### **3.3.7 Changes in Vibration Level with Battery Use (Recommended)**

If the battery that powers the motor (size AAA alkaline battery) wears out, the perceived vibration level will be reduced even if the requested vibration level remains the same. Therefore, rumble operation should be checked both when the battery is new (1.6 V) and when it is at the end of its life (1.1 V).

## **4. SGB PROGRAMMING CAUTIONS**

### **4.1 ROM Data (Required)**

To use the functions of SGB (system commands), the following values must be stored in ROM at the locations indicated.

0x146 ← 0x03, 0x14B ← 0x33

### **4.2 Default Data (Required)**

When writing programs that use the functions of SGB, use the initialization routine of the game program to send default data (see Chapter 6) to the register file.

### **4.3 SOU\_TRN Default Data (Required)**

When using the SOU\_TRN system command, send the SOU\_TRN default data (see Chapter 6) to the register file before SOU\_TRN is used.



## **5. PROGRAMMING CAUTIONS REGARDING POCKET PRINTER**

### **5.1 Transfer Time Intervals (Required)**

Transfer time intervals vary depending on the manufacturer. The timings indicated in Chapter 9 should be used to avoid faulty operation with a printer from a particular manufacturer.

### **5.2 Printing Multiple Sheets Continuously (Recommended)**

Between 2 and 255 sheets can be printed continuously by an application. However, because this may take a long time, the user should be given a means of halting a print job in progress.

### **5.3 Print Density (Recommended)**

Because it is very inconvenient to adjust the density each time the program is started, the print density data should be backed up whenever possible.

### **5.4 Operation After the Motor is Stopped (Required)**

If a print instruction packet is sent within 100 msec of when the motor is stopped, the print starting position may be incorrect. Therefore, print instruction packets should always be sent at least 100 msec after the motor is stopped.

### **5.5 Feeds (Required)**

In setting the number of line feeds to be inserted before and after printing (byte 2 of the data portion of the print instruction packet), always specify a value of 1 or greater for the number of feeds before printing and 3 or greater for the number after printing. Otherwise, problems can arise, such as double printing twice on a single line or failure of the last line of print to reach the paper cutter.

### **5.6 Point of Caution During Debugging (Recommended)**

There are two types printers, each made by a different manufacturer (Seiko Instruments and Hosiden). As part of final debugging, the program should be checked with at least one printer of each type.

### **5.7 Sample Program Provided by Nintendo (Recommended)**

Modifying the program to suit the intended use is permitted. However, in creating the original program, values for timing and other parameters were calculated to allow normal operation. These parameters must therefore be carefully considered when modifying the program.

## **6. PROGRAMMING CAUTIONS FOR U.S. PROGRAMMERS**

If you are unable to verify that the system is a Super Game Boy, and the Accumulator returns the same value if the game is inserted in the Super Game Boy or original Game Boy hardware, follow the instructions below.

If your game is Super Game Boy (SGB) enhanced, then you just need to use the MLT\_REQ function. Otherwise, you must use the SGB libraries to verify if the game is in an SGB. (These libraries are located in the CGB files section of Wario World under SGBlib.zip.) You will need to call the SGBCHK function from these libraries right after the Soft Reset label. To use this function, you must set the ROM Registration area for SGB (\$146h) to \$03, which allows access to the SGB Registers. (Don't forget to readjust the Complement Check.)

Also, on the Software Submission sheet, make sure you note that the game has a \$03 in address \$146, but in the remarks section, explain that the game doesn't use any of the SGB features.

<b>Appendix 2: Register and Instruction Set Summaries.....</b>	<b>260</b>
1. Control Register Summary.....	260
2. Sound Register Summary.....	265
3. CPU Instruction Set Summary.....	268

## APPENDIX 2: REGISTER AND INSTRUCTION SET SUMMARIES

### 1. CONTROL REGISTER SUMMARY

Register	Address	D7	D6	D5	D4	D3	D2	D1	D0	Comment
P1 Port P15- P10	FF00	/	/	P15	P14	P13	P12	P11	P10	RAW Control of transfer data by P14, P15
SB Serial transfer register	FF01									RAW Transfer data
SC Serial control	FF02	Transfer start 0: No start 1: Start	/	/	/	/	/	Clock speed 0: 8 KHz 1: 256 KHz	Shift clock 0: External 1: Internal	RAW In double-speed mode clock speed also doubled
DIV Divider	FF04	$f_2^{18}$ 64Hz	$f_2^{18}$ 128Hz	$f_2^{14}$ 256Hz	$f_2^{13}$ 512Hz	$f_2^{12}$ 1024Hz z	$f_2^{11}$ 2048Hz z	$f_2^{10}$ 4096Hz z	$f_2^9$ 8192Hz z	RAW With clear normal by LD instruction: #4194304 Double speed: #6388608
TIMA Timer	FF05									RAW Timer unit Operates at double-speed in double-speed mode
TMA Timer modulu	FF06									RAW Preset register for timer
TAC Timer control	FF07	/	/	/	/	/	Timer stop 0: Stop 1: Operate	Frequency selection bit 00: $f_2^{10}$ 10: $f_2^9$ 01: $f_2^4$ 11: $f_2^3$		RAW Normal-speed: #4194304 Double-speed: #6388608
IF Interrupt request flag	FF0F	/	/	/	Terminals P10-P13 HIGH	End of serial transfer	Timer overflow	LCDC Controller STAT	V-blank	RAW Bit reset valid
IE Interrupt enable flag	FFFF				Terminals P10-P13 LOW	End of serial transfer	Timer overflow	LCDC Controller STAT	V-blank	RAW 0: Disabled 1: Enabled
IME Interrupt master enable		/	/	/	/	/	/	/	/	Reset with DI; set with EI 0: Disable interrupts 1: Enable interrupts

Appendix 2: Register and Instruction Set Summaries

Register	Address	D7	D6	D5	D4	D3	D2	D1	D0	Comment
LCDC LCDC Control	FF40	Controller 0: Stop 1: Operate	WIN Area 0: 9800- 1: 9C00-	Window 0: OFF 1: ON	BG Characters 0: 8800- 1: 8000-	BG Area 0: 9800- 1: 9C00-	OBU Block 0: 8x8 1: 8x16	OBU Display 0: OFF 1: ON	BG Display 0: OFF 1: ON	RAM Bit 0 fixed to display BG ON in CGB mode only
STAT LCDC status information	FF41		LCDC status interrupt selection flags				LYC agreement 0: 1: LYC=LY	Mode 00: RAM access 10: OBU search 01: V-blank 11: LCD transfer		RAM Bits 3-6 Interrupt 0: Not selected 1: Selected
			Agreement flag selection	Mode 10 selection	Mode 01 selection	Mode 00 selection				
SCY Scroll Y register	FF42									RAM 0x00 – 0xFF
SCX Scroll X register	FF43									RAM 0x00 – 0xFF
LY LCDC y-coordinate	FF44									R y-coordinate during display
LYC LY compare register	FF45									RAM Agreement flag set with LYC=LY
DMA DMA Transfer	FF46									W 0x00 – 0xDF Transfer starts at the same time as address set

Register	Address	D7	D6	D5	D4	D3	D2	D1	D0	Comment
BGP BG Palette Data	FF47	Palette data for character dot data 11 in DMG mode.		Palette data for character dot data 10 in DMG mode.		Palette data for character dot data 01 in DMG mode.		Palette data for character dot data 00 in DMG mode.		W
OBPO OBJ palette data 0	FF48	Palette data for character dot data 11 in DMG mode.		Palette data for character dot data 10 in DMG mode.		Palette data for character dot data 01 in DMG mode.		Palette data for character dot data 00 in DMG mode.		W When attribute bit4 is 0.
OBP1 OBJ palette data 1	FF49	Palette data for character dot data 11 in DMG mode.		Palette data for character dot data 10 in DMG mode.		Palette data for character dot data 01 in DMG mode.		Palette data for character dot data 00 in DMG mode.		W When attribute bit4 is 1.
WY Window y-coordinate	FF4A									R/W 0 - 143 Top edge when WY=0
WX Window x-coordinate	FF4B									R/W 7 - 165 Left edge when WX=7
KEY1 CPU speed switching	FF4D	Current speed: 0: Normal 1: Double speed							Enable speed switching	R/W Switch by setting bit0 to 1 and issuing a STOP instruction
VBK VRAM bank specification	FF4F								Bank 0: Bank0 1: Bank1	R/W Bank0 selected immediately after a reset signal.
HDMA1 Higher-order address of HDMAtransfer source	FF51									W 0x00 - 0x7F (ROM) 0xA0 - 0xDF (WRAM)
HDMA2 Lower-order address of HDMAtransfer source	FF52									W 0x0X - 0xFF
HDMA3 Higher-order address of HDMAtransfer destination	FF53									W 0x00 - 0x1F
HDMA4 Lower-order address of HDMAtransfer destination	FF54									W 0x0X - 0xFF

Appendix 2: Register and Instruction Set Summaries

Register	Address	D7	D6	D5	D4	D3	D2	D1	D0	Comment
HDMA5 H-blank and general- purpose DMA control	FF55	DMA selection 0: General purpose 1: H- blank	$0 \leq n \leq 127$ Total number of transferred bytes: $16 \times (n+1)$							W H-blanking stopped by setting bit 7 to 0; General- purpose stopped by resetting
RP Infrared communication port	FF5B	Data read-enable flag 00: Disable 11: Enable						Read data 0:LED-ON 1:LED-OFF	Write data 0:LED-OFF 1:LED-ON	R/W
BCPS Color palette BG write specification	FF68	Increment 0: OFF 1: ON		Palette No. 0 - 7			Palette No. 0 - 3		H/L specification 0: L 1: H	R/W Not incremented automatically with a read
BCPD Color palette BG write data	FF69									R/W
OCPS Color palette OBJ write specification	FF6A	Increment 0: OFF 1: ON		Palette No. 0 - 7			Palette No. 0 - 3		H/L specification 0: L 1: H	R/W Not incremented automatically with a read
OCPD Color palette OBJ write data	FF6B									R/W

Register	Address	D7	D6	D5	D4	D3	D2	D1	D0	Comment
SVBK WRAM Bank specification	FF70						Banks specification 0,1: Specifies bank 1 2-7: Specifies banks 2-7			R/W
<u>OBU0</u> <sup>*1</sup> LCD y-coordinate	FE00									R/W 0x00-0xFF Top edge when Y=0x10
LCD x-coordinate	FE01									R/W 0x00-0xFF Left edge when X=0x08
Character code	FE02									R/W 0x00-0xFF
Attribute flag	FE03	Display priority 0: OBJ 1: BG	Vertical flip 0: Normal 1: Flip	Horizontal flip 0: Normal 1: Flip	Palette specification for DMG mode	VRAM bank 0: bank 0 1: bank 1	Color Palette No. 0-7			R/W
*1 OBJ1 - OBJ39 same as OBJ0										

The dark frame  indicates a flag or register unique to CGB.



## 2. SOUND REGISTER SUMMARY

All values shown in the following table apply to normal mode. The values for double-speed mode should be calculated by doubling the system clock frequency.

	Register	Address	D7	D6	D5	D4	D3	D2	D1	D0	Comment	
S O U N D  1	NR10	FF10	/	Sweep time: 010:15.6ms 101:39.1ms 000:OFF 011:23.4ms 110:46.9ms 001:7.8ms 100:31.3ms 111:54.7ms			Sweep increase /decrease 0: + f hi 1: - f low	Number of sweep shifts: 0 - 7			R/W $f_{128}=128\text{Hz}$	
	NR11	FF11		Waveform duty cycle 00: 12.5% 10: 50% 01: 25% 11: 75%	Sound length data t1 : 0 - 63 Sound length = $(64+t1) * (1/256)$ sec						R/W	
	NR12	FF12		Initial envelope value: 0x00 - 0x0F Mute when 0x00 Maximum when 0x0F	Envelope U/D 0: Attenuate 1: Amplify			Number of envelope steps N = 0 - 7 Length of 1 step = $N^2(1/64)$ sec Envelope function stopped when N=0			R/W Initial value of 00 sets to OFF when in DOWN mode	
	NR13	FF13		Lower order 8 bits of frequency data								W
	NR14	FF14		Restart when initialize flag set to 1	Length selection 0: Consecutive 1: NR11	/	/	/	Higher order 3 bits of frequency data With x=11-bit frequency data, $f = 4194304 / (4^2 * (2048-x))$ Hz			R/W f = 64Hz - 131KHz
S O U N D  2	NR21	FF16	/	Waveform duty cycle 00: 12.5% 10: 50% 01: 25% 11: 75%			Sound length t1: 0 - 63 Sound length = $(64+t1) * (1/256)$ sec			R/W		
	NR22	FF17		Initial envelope value 0x00 - 0x0F Mute when 0x00 Maximum when 0x0F	Envelope U/D 0: Attenuate 1: Amplify			Number of envelope steps N = 0-7 Length of 1 step = $N^2(1/64)$ sec Envelope function stops when N=0			R/W Initial value of 00 sets to OFF when in DOWN mode	
	NR23	FF18		Lower order 8 bits of frequency data,								W
	NR24	FF19		Restart when initialize flag set to 1	Length selection 0: Consecutive 1: NR21	/	/	/	Higher order 3 bits of frequency data With x=11-bit frequency data, $f = 4194304 / (4^2 * (2048-x))$ Hz			R/W f = 64Hz - 131KHz

	Register	Address	D7	D6	D5	D4	D3	D2	D1	D0	Comment
S O U N D  3	NR30 Sound OFF	FF1A	Sound OFF 0: OFF 1: ON								R/W
	NR31 Sound length data	FF1B	Sound length data t1 : 0 - 255 Sound length = (256-t1) * (1/256) sec								R/W
	NR32 Output level	FF1C		Output level 00: Mute 10: 1/2 01: Max 11: 1/4							R/W
	NR33 Lower-order frequency data	FF1D	Lower-order 8 bits of frequency data								W
	NR34 Higher-order frequency data/other	FF1E	Restart when initialize flag set to 1	Length selection 0: Conservative 1: NR31					Higher-order 3 bits of frequency data With x=11-bit frequency data, f = 4194304 / (2 <sup>x</sup> * 2048) Hz		R/W f = 64Hz - 131KHz

Appendix 2: Register and Instruction Set Summaries

Register	Address	D7	D6	D5	D4	D3	D2	D1	D0	Comment	
NR41 Sound length data	FF20	/	/	Sound length data t1 : 0 - 63 Sound length = (64-t1) * (1/256) sec						RAW	
NR42 Envelope	FF21	Initial envelope value 0x00 – 0x0F Mute when 0x00 Max when 0x0F			Envelope U/D 0: Attenuate 1: Amplify	Number of envelope steps N=0-7 Length of 1 step = N*(1/64) sec Envelope function stops when N=0				RAW Initial value of 00 sets to OFF when in DOWN mode	
NR43 Polynomial counter	FF22	Polynomial counter clock frequency selection 0000: f <sub>0</sub> *1/2    1100: f <sub>0</sub> *1/2 <sup>10</sup> 0001: f <sub>0</sub> *1/2 <sup>2</sup> 1101: f <sub>0</sub> *1/2 <sup>14</sup>			Prohibited codes 1110 1111		Step no. selection 0: 15 steps 1: 7 steps	Selection of frequency dividing ratio f <sub>s</sub> 000: f*1/2 <sup>2</sup> 110: f*1/2 <sup>3</sup> *1/6 001: f*1/2 <sup>3</sup> *1/1 to 000: f*1/2 <sup>2</sup> *1/7			W f=4.194304MHz
NR44 Initialize/length	FF23	Restart when initialize flag set to 1	Length selection 0: Consecutive 1: NR41	/	/	/	/	/	/	RAW	
NR50 SO1/SO2 level	FF24	VIN input 0: SO2 OFF 1: SO2 output	SO2 output level control 000 (min) – 111 (max)			VIN input 0: SO1 OFF 1: SO1 output	SO1 output level control 000 (min) – 111 (max)			RAW	
NR51 Distribution to SO1/SO2	FF25	Sound 4 to SO2	Sound 3 to SO2	Sound 2 to SO2	Sound 1 to SO2	Sound 4 to SO1	Sound 3 to SO1	Sound 2 to SO1	Sound 1 to SO1	RAW 0: No output 1: Output	
NR52 Sound-end flag	FF26	All sounds 0: Stop 1: Play	/	/	/	Sound 4 ON flag	Sound 3 ON flag	Sound 2 ON flag	Sound 1 ON flag	RAW	

Waveform RAM

Waveform RAM is made up of waveform patterns consisting of 4 bits x 32 steps.

Address	D7	D6	D5	D4	D3	D2	D1	D0
FF30	Step 0				Step 1			
FF31	Step 2				Step 3			
FF32	Step 4				Step 5			
⋮								
FF3F	Step 30				Step 31			

### 3. CPU INSTRUCTION SET SUMMARY

	MNEMONIC	SYMBOLIC OPERATION	FLAGS				CYCL	OP-CODE 76 543 210	COMMENT
			CY	H	N	Z			
8-Bit Transfer/Input-Output Instructions	LD r,r'	$r \leftarrow r'$	--	--	-	--	1	01 r r'	
	LD r,n	$r \leftarrow n$	--	--	-	--	2	00 r 110 $\leftarrow n \rightarrow$	
	LD r,(HL)	$r \leftarrow (HL)$	--	--	-	--	2	01 r 110	Register r,r'
	LD (HL),r	$(HL) \leftarrow r$	--	--	-	--	2	01 110 r	A 111
	LD (HL),n	$(HL) \leftarrow n$	--	--	-	--	3	00 110 110 $\leftarrow n \rightarrow$	B 000 C 001
	LD A,(BC)	$A \leftarrow (BC)$	--	--	-	--	2	00 001 010	D 010
	LD A,(DE)	$A \leftarrow (DE)$	--	--	-	--	2	00 011 010	E 011
	LD A,(C)	$A \leftarrow (FF00H + C)$	--	--	-	--	2	11 110 010	H 100
	LD (C),A	$(FF00H + C) \leftarrow A$	--	--	-	--	2	11 100 010	L 101
	LD A,(n)	$A \leftarrow (n)$	--	--	-	--	3	11 110 000 $\leftarrow n \rightarrow$	
	LD (n),A	$(n) \leftarrow A$	--	--	-	--	3	11 100 000 $\leftarrow n \rightarrow$	
	LD A,(nn)	$A \leftarrow (nn)$	--	--	-	--	4	11 111 010 $\leftarrow n \rightarrow$ $\leftarrow n \rightarrow$	
	LD (nn),A	$(nn) \leftarrow A$	--	--	-	--	4	11 101 010 $\leftarrow n \rightarrow$ $\leftarrow n \rightarrow$	
	LD A,(HL)	$A \leftarrow (HL)$ $HL \leftarrow HL + 1$	--	--	-	--	2	00 101 010	
	LD A,(HLD)	$A \leftarrow (HL)$ $HL \leftarrow HL - 1$	--	--	-	--	2	00 111 010	
	LD (BC),A	$(BC) \leftarrow A$	--	--	-	--	2	00 000 010	
	LD (DE),A	$(DE) \leftarrow A$	--	--	-	--	2	00 010 010	
	LD (HLI),A	$(HL) \leftarrow A$ $HL \leftarrow HL + 1$	--	--	-	--	2	00 100 010	Register Pair dd BC 00

Appendix 2: Register and Instruction Set Summaries

	MNEMONIC	SYMBOLIC OPERATION	CY	FLAGE H	N	Z	CYCL	OP-CODE 76 543 210	Register Pair	dd	
	16-Bit Transfer Instructions	LD (HLD),A	(HL) ← A HL ← HL - 1	--	--	-	--	2	00 110 010	DE	01
									HL	10	
LD dd,nn		dd ← nn	--	--	-	--	3	00 cd0 001	SP	11	
								L-ADRS ← n →			
								H-ADRS ← n →	Register Pair	qq	
LD SP,HL		SP ← HL	--	--	-	--	2	11 111 001	BC	00	
PUSH qq		(SP-1) ← qqH (SP-2) ← qqL SP ← SP-2	--	--	-	--	4	11 qq0 101	DE	01	
									HL	10	
									AF	11	
POP qq		qqL ← (SP) qqH ← (SP+1) SP ← SP-2	--	--	-	--	3	11 qq0 001	e=-128~+127		
LDHL SP,e	HL ← SP+e	+	+	0	0	3	11 111 000				
							← e →				
LD (nn),SP	(nn) ← SPL (nn+1) ← SPH	--	--	-	--	5	00 c01 000				
							L-ADRS ← n →				
							H-ADRS ← n →				

	MNEMONIC	SYMBOLIC OPERATION	FLAGS				CYCL	OP-CODE 76 543 210	COMMENT
			CY	H	N	Z			
8-Bit Arithmetic and Logical Operation Instructions	ADD A,r	$A \leftarrow A+r$	*	*	0	*	1	10 000 r	s is any of r,n,(HL)  CYCL 1: s is r 2: s is n or (HL)
	ADD A,n	$A \leftarrow A+n$	*	*	0	*	2	11 000 110 $\leftarrow n \rightarrow$	
	ADD A,(HL)	$A \leftarrow A+(HL)$	*	*	0	*	2	10 000 110	
	ADC A,s	$A \leftarrow A+s+CY$	*	*	0	*	1,2	-- --- ---	
	SUB s	$A \leftarrow A-s$	*	*	1	*	1,2	-- --- ---	
	SBC A,s	$A \leftarrow A-s-CY$	*	*	1	*	1,2	-- --- ---	
	AND s	$A \leftarrow A \wedge s$	0	1	0	*	1,2	-- --- ---	
	OR s	$A \vee s$	0	0	0	*	1,2	-- --- ---	
	XOR s	$A \oplus s$	0	0	0	8	1,2	-- --- ---	
	CP s	$A-s$	*	*	1	*	1,2	-- --- ---	
	INC r	$r \leftarrow r+1$	--	*	0	*	1	00 r 100	
	INC (HL)	$(HL) \leftarrow (HL)+1$	--	*	0	*	3	00 110 100	
DEC r	$r \leftarrow r-1$	--	*	1	*	1	00 r 101		
DEC (HL)	$(HL) \leftarrow (HL)-1$	--	*	1	*	3	00 110 101		
16-Bit Arithmetic Operation Instructions	ADD HL,ss	$HL \leftarrow HL+ss$	*	*	0	--	2	00 ss1 001	HL 10
	ADD SP,e	$SP \leftarrow SP+e$	*	*	0	0	4	11 101 000 $\leftarrow e \rightarrow$	SP 11
	INC ss	$ss \leftarrow ss+1$	--	--	--	--	2	00 ss0 011	e=-128~+127
	DEC ss	$ss \leftarrow ss-1$	--	--	--	--	2	00 ss1 011	

The flag is affected according to the result of the operation.

Z: Zero flag. z=1 if the result of the operation is 0  
 C: Carry/link flag. C=1 if the operation produced a carry from the MSB of the operand or result  
 H: Half-carry flag.  
 N: Add/Subject flag.

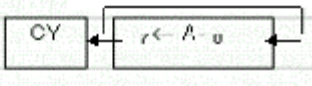
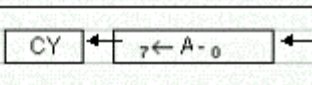
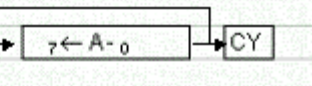
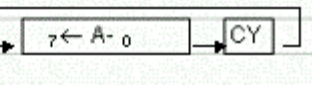
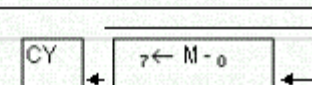
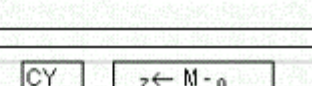
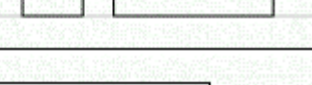
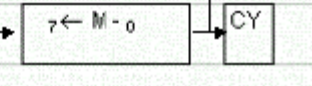
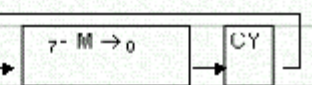
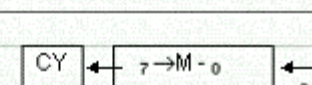
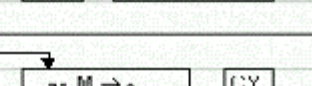
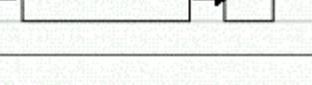
	MNEMONIC	SYMBOLIC OPERATION	FLAGS				CYCL	OP-CODE 76 543 210	COMMENT	
			CY	H	N	Z				
Rotate Shift Instructions	RLCA		A <sub>7</sub>	0	0	0	1	00 000 111	Register	r
	RLA		A <sub>7</sub>	0	0	0	1	00 010 111	A	111
	RRC A		A <sub>0</sub>	0	0	0	1	00 001 111	D	000
	RRA		A <sub>0</sub>	0	0	0	1	00 011 111	C	001
	RLC m		m <sub>7</sub>	0	0	*	--	-- --- ---	D	010
	RL m		m <sub>7</sub>	0	0	*	--	-- --- ---	E	011
	RRC m		m <sub>0</sub>	0	0	*	--	-- --- ---	H	100
	RR m		m <sub>0</sub>	0	0	*	--	-- --- ---	L	101
	SLA m		m <sub>7</sub>	0	0	*	--	-- --- ---	mis any of (HL)	CYCL
	SRA m		m <sub>0</sub>	0	0	*	--	-- --- ---	RLC r	2
	SRL m		m <sub>0</sub>	0	0	*	--	-- --- ---	RLC (HL)	4
	SWAP m		0	0	0	*	--	-- --- ---	RL r	2
									RR (HL)	4
									SLA (HL)	4
								SRA (HL)	4	
								SRL (HL)	4	
								SWAP r	2	
								SWAP (HL)	4	

	MNEMONIC	SYMBOLIC OPERATION	FLAGS				CYCL	OP-CODE 76 543 210	COMMENT																																				
			C <sup>v</sup>	H	N	Z																																							
Bit Operations	BIT b,r	$Z \leftarrow \overline{b}$	--	1	0	$\overline{r}$	2	11 00' 011 01 b r	<table border="1"> <thead> <tr> <th>R#</th> <th>b</th> <th>Register</th> <th>r</th> </tr> </thead> <tbody> <tr> <td>0</td> <td>000</td> <td>A</td> <td>111</td> </tr> <tr> <td>1</td> <td>001</td> <td>B</td> <td>000</td> </tr> <tr> <td>2</td> <td>010</td> <td>C</td> <td>001</td> </tr> <tr> <td>3</td> <td>011</td> <td>D</td> <td>010</td> </tr> <tr> <td>4</td> <td>100</td> <td>E</td> <td>U11</td> </tr> <tr> <td>5</td> <td>101</td> <td>H</td> <td>100</td> </tr> <tr> <td>6</td> <td>110</td> <td>L</td> <td>101</td> </tr> <tr> <td>7</td> <td>111</td> <td></td> <td></td> </tr> </tbody> </table>	R#	b	Register	r	0	000	A	111	1	001	B	000	2	010	C	001	3	011	D	010	4	100	E	U11	5	101	H	100	6	110	L	101	7	111		
	R#	b	Register	r																																									
	0	000	A	111																																									
	1	001	B	000																																									
	2	010	C	001																																									
	3	011	D	010																																									
4	100	E	U11																																										
5	101	H	100																																										
6	110	L	101																																										
7	111																																												
	BIT b,(HL)	$Z \leftarrow (HL)_b$	--	1	0	(HL) <sub>b</sub>	3	11 00' 011 01 b 110																																					
	SET <sup>-</sup> b,r	$b \leftarrow 1$	--	--	--	--	2	11 00' 011 11 b r																																					
	SET b,(HL)	$(HL)_b \leftarrow 1$	--	--	--	--	4	11 UU' U11 11 b 110																																					
	RES b,r	$b \leftarrow 0$	--	--	--	--	2	11 00' 011 10 b r																																					
	RES b,(HL)	$(HL)_b \leftarrow 0$	--	--	--	--	4	11 00' 011 10 b 110																																					
Jump Instructions	JP nn	$PC \leftarrow nn$	--	--	--	--	4	11 000 011 L-ADRS H-ADRS $\leftarrow n \rightarrow$ $\leftarrow n \rightarrow$	<p>* No. of cycles is 3 when no cc agreement:</p> <table border="1"> <thead> <tr> <th>CC</th> <th>Condition</th> <th>Flag</th> </tr> </thead> <tbody> <tr> <td>00</td> <td>NZ</td> <td>Z=0</td> </tr> <tr> <td>01</td> <td>Z</td> <td>Z=1</td> </tr> <tr> <td>10</td> <td>NC</td> <td>CY=0</td> </tr> <tr> <td>11</td> <td>C</td> <td>CY=1</td> </tr> </tbody> </table> <p>e=-127~+129</p>	CC	Condition	Flag	00	NZ	Z=0	01	Z	Z=1	10	NC	CY=0	11	C	CY=1																					
	CC	Condition	Flag																																										
	00	NZ	Z=0																																										
	01	Z	Z=1																																										
	10	NC	CY=0																																										
11	C	CY=1																																											
	JP cc,nn	If cc true, $PC \leftarrow nn$	--	--	--	--	4/3	11 0cc 010 L-ADRS H-ADRS $\leftarrow n \rightarrow$ $\leftarrow n \rightarrow$																																					
	JR e	$PC \leftarrow PC+e$					3	00 01' 000 $\leftarrow e-2 \rightarrow$																																					
	JR cc,e	If cc true, $PC \leftarrow PC+e$	--	--	--	--	3/2	00 1cc 000 $\leftarrow e-2 \rightarrow$																																					
	JP (HL)	$PC \leftarrow HL$	--	--	--	--	1	11 10' 001																																					
Call/Return Instructions	CALL nn	$(SP-1) \leftarrow PC_H$ $(SP-2) \leftarrow PC_L$ $PC \leftarrow nn$ $SP \leftarrow SP-2$	--	--	--	--	6	11 00' 101 L-ADRS H-ADRS $\leftarrow n \rightarrow$ $\leftarrow n \rightarrow$	<table border="1"> <thead> <tr> <th>Operands</th> <th>t</th> <th>(PC<sub>H</sub>)</th> <th>(PC<sub>L</sub>)</th> </tr> </thead> <tbody> <tr> <td>0</td> <td>000</td> <td>0x00</td> <td>0x00</td> </tr> <tr> <td>1</td> <td>UU1</td> <td>UxJU</td> <td>UxU8</td> </tr> <tr> <td>2</td> <td>010</td> <td>0x00</td> <td>0x10</td> </tr> <tr> <td>3</td> <td>011</td> <td>0x00</td> <td>0x18</td> </tr> <tr> <td>4</td> <td>100</td> <td>0x00</td> <td>0x20</td> </tr> <tr> <td>5</td> <td>101</td> <td>0x00</td> <td>0x28</td> </tr> <tr> <td>6</td> <td>110</td> <td>0x00</td> <td>0x30</td> </tr> <tr> <td>7</td> <td>111</td> <td>0x00</td> <td>0x38</td> </tr> </tbody> </table>	Operands	t	(PC <sub>H</sub> )	(PC <sub>L</sub> )	0	000	0x00	0x00	1	UU1	UxJU	UxU8	2	010	0x00	0x10	3	011	0x00	0x18	4	100	0x00	0x20	5	101	0x00	0x28	6	110	0x00	0x30	7	111	0x00	0x38
	Operands	t	(PC <sub>H</sub> )	(PC <sub>L</sub> )																																									
	0	000	0x00	0x00																																									
	1	UU1	UxJU	UxU8																																									
	2	010	0x00	0x10																																									
	3	011	0x00	0x18																																									
4	100	0x00	0x20																																										
5	101	0x00	0x28																																										
6	110	0x00	0x30																																										
7	111	0x00	0x38																																										
	CALL cc,nn	If cc true, $(SP-1) \leftarrow PC_H$ $(SP-2) \leftarrow PC_L$ $PC \leftarrow nn$ $SP \leftarrow SP-2$	--	--	--	--	6/3	11 0cc 100 L-ADRS H-ADRS $\leftarrow n \rightarrow$ $\leftarrow n \rightarrow$																																					
	RET	$PC_L \leftarrow (SP)$ $PC_H \leftarrow (SP+1)$ $SP \leftarrow SP+2$	--	--	--	--	4	11 00' 001																																					
	RETI	$PC_L \leftarrow (SP)$ $PC_H \leftarrow (SP+1)$ $SP \leftarrow SP+2$	--	--	--	--	4	11 011 001																																					
	RET cc	If cc true, $PC_L \leftarrow (SP)$ $PC_H \leftarrow (SP+1)$ $SP \leftarrow SP+2$	--	--	--	--	5/2	11 0cc 000																																					
	RST t	$(SP-1) \leftarrow PC_H$ $(SP-2) \leftarrow PC_L$ $SP \leftarrow SP-2$ $PC_H \leftarrow 0$ $PC_L \leftarrow P$	--	--	--	--	4	11 t 111																																					



Appendix 2: Register and Instruction Set Summaries

	MNEMONIC	SYMBOLIC OPERATION	FLAGS				CYCL	OP-CODE 76 543 210	COMMENT
			CY	H	N	Z			
Gen-Purpose/Arithmetic/CPU Control Instructions	DAA	Decimal Adjust acc	*	0	--	*	1	00 100 111	
	CPL	$A \leftarrow \overline{A}$	-	1	1	--	1	00 101 111	
	NOP	No operation	-	--	--	--	1	00 000 000	
	CCF	$CY \leftarrow \overline{CY}$	$\overline{CY}$	0	0	--	1	00 111 111	
	SCF	$CY \leftarrow 1$	1	0	0	--	1	00 110 111	
	DI	$IME \leftarrow 0$	-	--	--	--	1	11 110 011	
	EI	$IME \leftarrow 1$	-	--	--	--	1	11 111 011	
	HALT	Halt	-	--	--	--	1	01 110 110	
	STOP	Stop	-	--	--	--	1	00 010 000	
								00 000 000	

***THIS PAGE WAS INTENTIONALLY LEFT BLANK.***

<b>APPENDIX 3: SOFTWARE SUBMISSION REQUIREMENTS.....</b>	<b>276</b>
<b>1. The Software Submission Process .....</b>	<b>276</b>
<b>2. Items Required for Submission .....</b>	<b>276</b>
<b>3. Software Verification.....</b>	<b>277</b>
<b>4. Licensee Game Play Videotape Pass/Fail Guidelines.....</b>	<b>278</b>
<b>5. Licensing Screen Information Pass/Fail Guidelines.....</b>	<b>278</b>
<b>6. Common Problems .....</b>	<b>279</b>
<b>7. A Note on Objectionable Material .....</b>	<b>280</b>
<b>8. Software Submission Checklist.....</b>	<b>281</b>
<b>9. Instructions For Software Specification Sheet.....</b>	<b>282</b>
<b>10. Character Code List For Game Title Registration .....</b>	<b>287</b>
<b>11. ROM Registration Data Specification .....</b>	<b>288</b>
<b>11.1 Description of ROM Registration Data .....</b>	<b>289</b>
<b>12. Storing Data to the Floppy Disk.....</b>	<b>293</b>
<b>13. Production Software Selection .....</b>	<b>294</b>
<b>14. Development Software Selection.....</b>	<b>295</b>
<b>15. Game Content Guidelines.....</b>	<b>297</b>
<b>16. Game Boy Price Quote Request Form .....</b>	<b>298</b>

## APPENDIX 3: SOFTWARE SUBMISSION REQUIREMENTS

### 1. THE SOFTWARE SUBMISSION PROCESS

All software submissions to Nintendo of America Inc. must be forwarded to the attention of NOA Product Testing Supervisor. Otherwise, the submission's placement into the testing queue may be delayed. To help reduce a submission's turn-around time, it is suggested that licensees assign a primary contact person for each software submission. All communications with NOA concerning a submission's testing status should be forwarded through this individual. The contact person should also be responsible for notifying any other interested parties.

When a submission is approved, your company's primary contact will be notified immediately in writing.

When a submission is not approved, NOA may send a videotaped copy of the programming problem(s) which prevent(s) the submission from being approved. This is intended to assist the licensee in analyzing the cause of the software problem. It is the licensee's responsibility to send a copy of this tape to any developer(s) of the software. NOA strongly encourages that copies be sent to the software developer(s) as quickly as possible.

Software submissions should be sent to the following address:

Nintendo of America Inc.  
Attn: Product Testing Supervisor  
4820 150th Avenue NE  
Redmond, WA 98052  
Phone: (425) 861-2674  
Fax: (425) 882-3585

### 2. ITEMS REQUIRED FOR SUBMISSIONS

The following items must be submitted with each Game Boy software submission.

#### ***Specification Sheet and Check List***

The appropriate Software Specification sheet and the Software Submission Checklist must be filled out completely and must be correct for the particular program version.

#### ***ROM Data***

A copy of the ROM data must be submitted in binary format on MS-DOS® 3.5 inch disk(s). The size of the file must be equal to the size of the EP-ROM (i.e., one 4 Meg EP-ROM = one 4 Meg file). Please label each disk and include a description of its contents. (See "Storing Data to the Floppy Disk" below.)

**Note** *For software that supports communications, when communications are delayed for more than one hour after the game starts, in addition to the above items, you must submit one set of boards with EP-ROM (or a flash board) in which the game has been advanced to the point where communication can take place.*

#### ***Game Play Videotape/Rating Certificate***

A video tape containing complete game play is required unless the product has been rated by the Entertainment Software Ratings Board (ESRB). If the product has been rated by the ESRB, then a copy of the rating certificate must accompany the submission and no video tape is needed.

### **Screen Text**

A printed copy of the complete screen text must be submitted.

### **Instruction Manual**

One copy of the instruction manual must be included with your game submission. If, at the time of submission the manual is not complete, (submitted as an intermediate version) then you must submit a list of known bugs.

**Note** *If any of these items are not satisfied, the program will be rejected and will not be submitted into the approval process until all criteria are met.*

## **3. SOFTWARE VERIFICATION**

The following verification process will significantly improve the probability of approval of your software.

1. The licensing screen on all submissions should state "LICENSED BY NINTENDO".
2. Confirm the Licensing Screen information is correct.
3. Check the spelling on the Licensing Screen and Title Screen, as well as the spelling and grammar on the screen text.
4. Confirm the use of a TM (™), circle R (®), or circle C (©) where applicable.
5. Run a "Bypass" Test to assure that when the game is powered up, the Licensing Screen is visible for at least one second, even if any combination of controller buttons are pressed repeatedly. Also "Power-up" the software repeatedly to assure it does so without programming failures.
6. Game characters should be moved in all possible directions or positions, regardless of whether it is required to play the game properly. For instance, if the game does not require going to a particular area to complete the game, go there anyway to assure there are no programming problems in going to that location.
7. The software should be paused many times during the test, as this often causes programming problems to surface.
8. All testing should be recorded onto a videotape, making it easier to review programming problems.
9. The entire attract mode (demo) should be viewed to assure there are no programming problems.
10. Routines designed to assist the programmer or developer in "debugging" the software should be removed from the game prior to submission. This includes routines to determine hardware type.

11. A Game Boy Color dedicated game must include a hardware check upon power-up, which will display the following message when it is connected to a device other than Game Boy Color. The official game title must also be displayed in the upper portion of the display screen.

--<Game Title>--

"This game can only be played on Game Boy Color"

#### **4. LICENSEE GAME PLAY VIDEOTAPE PASS/FAIL GUIDELINES**

1. The licensee game play videotape (if included) must be recorded on a VHS tape, Standard Play speed (SP) for clarity.
2. No editing of the tape is allowed.
3. If more than one tape is needed to show the entire piece of software, then when a second tape begins it must show that the player is in the exact same place as where the first tape left off.
4. No codes or "built-up" characters are allowed.
5. All levels or areas must be completed, in succession.
6. Screen text must have correct grammar and spelling.
7. No deviations from NOA Software Standards Policy may be present.
8. The entire ending credits (if any) must be shown.
9. If the product has been rated by the ESRB, then a copy of the rating certificate must accompany the submission and no videotape is needed.

#### **5. LICENSING SCREEN INFORMATION PASS/FAIL GUIDELINES**

The following Licensing information should be included for all software. This can be displayed on one (1) or two (2) screens.

1. Licensee's software title.
2. Licensee's trademark and copyright notice  
( \_ 19\_\_ Licensee's name or copyright owner)
3. LICENSED BY NINTENDO

***Example***

Tom's Golf™ or ®  
© 1992 ABC Corporation  
LICENSED BY NINTENDO

If a blank screen appears for more than two seconds when powered up, Nintendo suggests placing a message or graphic on the screen so that consumers do not think their game is inoperable (e.g., -- "Please Wait"--). If a blank screen appears for more than five seconds during game play, a message or graphic should also be placed on the screen.

## 6. COMMON PROBLEMS

Some possible problems that may prevent approval of your software include, but are not limited to the following:

1. Software locks up.
2. Scrambled blocks or characters appear on the screen.
3. The software won't pause.
4. Your character can get stuck somewhere with no possible way to get out.
5. Scrambled graphics at the edges of the screen when the screen scrolls in any direction.
6. Vowels in the passwords or password entry-system.
7. Colored lines at the top or bottom of the screen.
8. Shifting of the screen in any direction.
9. Inconsistent scoring methods.
10. Flashes on screen.
11. Small flickering lines on the screen.
12. Hit or be hit by an enemy but no damage is incurred.
13. Three (3) or four (4) player game can be started without using a four player adapter.
14. Incorrect Licensing Screen; "Licensed by Nintendo" should appear for all formats.
15. Violation of any Programming Cautions in the product programming manual.
16. Communication problems on two-player linkable DMG games.
17. Horizontal or vertical black lines when switching between screens on DMG games.
18. Use of the Nintendo logo or representations of Nintendo products in software without license agreement.
19. The use of the term Super Nintendo or Nintendo when the Super Nintendo Entertainment System or Nintendo Entertainment System is the intended reference, respectively. Use of any term other than Nintendo 64 or N64 when the Nintendo 64 Entertainment System is the intended reference.
20. Character actions are inconsistent (for instance, a character that cannot fly, being able to walk off the edge of a platform and stand in midair).
21. Referring to the Nintendo Control Pad or Control Stick by an unacceptable term, such as; "joypad", "directional control", etc.
22. Referring to the Nintendo Controller by an unacceptable term, such as; "joystick", etc.
23. Referring to the Nintendo Game Pak by an unacceptable term, such as; "Game Cassette", etc.
24. Referring to the Game Boy Game Link by an unacceptable term, such as; "Video Link", etc.

**Note** *If Licensor approval is required, please assure that this has been finalized before the software submission has been made.*

## **7. A NOTE ON OBJECTIONABLE MATERIAL**

A copy of the Nintendo "Game Content Guidelines" is included at the end of this document. If you are unsure of whether an item of text or element of a game is within Nintendo Software Standards, you may contact our Engineering Department early in the development process and they will discuss questionable items over the phone. In cases concerning an extensive amount of text, please send it to the attention of NOA Product Testing Supervisor, at the address listed in below, with the questionable items highlighted. The material will be evaluated and you will be contacted within a week to ten days.

Nintendo of America Inc.  
Attn: Product Testing Supervisor  
4820 150th Avenue NE  
Redmond, WA 98052  
Phone:(425) 861-2674  
Fax: (425) 882-3585



## 8. SOFTWARE SUBMISSION CHECKLIST

### SOFTWARE SUBMISSION CHECKLIST

MACHINE TYPE     SNS     NUS     DMG     CGB

GAME NAME        \_\_\_\_\_

COMPANY            \_\_\_\_\_

GAME CODE        SNS \_ \_ \_ \_    NUS \_ \_ \_ \_

                          DMG \_ \_ \_ \_    CGB \_ \_ \_ \_

VERSION

- Evaluation
- Approval Ver. \_\_\_\_
- Specification Sheet
- 1 Set of ROMs
- MS-DOS<sub>3 1/2</sub> Disk(s)  
(Files must be in binary format)
- 1 copy of Custom DSP IC if applicable  
(Super NES submissions only)
- 1 copy of VHS tapes or ESRB Rating  
Certificate
- Screen Text
- Instruction Manual or Game Play Instructions

REMARKS

\_\_\_\_\_

\_\_\_\_\_

\_\_\_\_\_

\_\_\_\_\_

**Note** This checklist must be included with the software submission. If any of the items are not satisfied, the program will be promptly returned and will not be submitted into the approval process until all criteria are met.

## 9. INSTRUCTIONS FOR SOFTWARE SPECIFICATION SHEET

1. Game Title  
Print the planned name for the game. You may use up to 11 characters.
2. Game Code  
Print the product code designated by Nintendo. Use "CGB-P-" for CGB-dedicated software (software that will not operate on a conventional Game Boy). Otherwise, use "DMG-P-".
3. Language  
Indicate the primary language used for messages, etc. in the game.
4. DMG Communication Mode  
Indicate whether the software has a function which uses an external expansion connector for Game Boy (or Super Game Boy), like a Game Boy communication cable.
5. Software Type  
Indicate whether the game being submitted is DMG exclusive, DMG/CGB compatible, or CGB exclusive.
6. CGB-related Functions  
Check the following items, as appropriate, if you selected "DMG/CGB compatible" or "CGB exclusive" in item 5.
  - a. Serial Transfer Speed (check all that apply)  
Check all corresponding communication speeds.
  - b. High Speed ROM Required?  
A high speed ROM is required if CPU double-speed mode (Key 1), horizontal blanking DMA, or general DMA is used.

**Note: These 3 functions cannot be used in MBC-1, 2, and 3.**

- c. IR Communications  
If the software has CGB infrared communications capabilities, please indicate whether the function involves communications with the same game or with a different game. If you select "different game," include the game title in the parentheses.
7. Overseas Version  
If the game has been, or will be, sold in another country; indicate the product title and product code.
8. Contact  
Provide the company name, department, address, phone number, fax number, and the name of a representative that Nintendo should contact with all questions or comments about the product.

9. Submission Date

Provide the submission date and select the method used for submission.

10. Scheduled Release Date

Provide the scheduled release date for the game.

11. ROM Registration Data

Provide the contents registered in the indicated addresses of the master ROM. Refer to "ROM Registration Data Specification" for details. Enter the ASCII code for the characters in areas marked with parenthesis "( )".

12. Game Title Registration

Enter the game title registered in the master ROM using ASCII characters and their ASCII codes. Also enter the Game Code assigned by Nintendo. Refer to "Character Code List for Game Title Registration" for these entries.

13. Memory Controller

Indicate the type of memory controller used for this game. If no Memory Controller is used, mark None.

14. Memory Configuration

Indicate the memory configuration of the game, as follows.

- ◆ ROM: Indicate the ROM size.
- ◆ RAM: Indicate whether or not work RAM is installed in the Game Pak. If work RAM is installed, indicate whether it is used as an expansion device or contained inside an MBC. If it is used as an expansion device, indicate the size of the RAM in the location provided. Also indicate if work RAM requires data back-up (battery). When the MBC-3 Clock Counter function is used, check "Yes" for "Data Back-up", regardless of which box is checked for "RAM".



**Example:**

16. File Name and Check Sums

Print the file name on each disk using the following format: \*\*\* \*\*-.GB

Example:

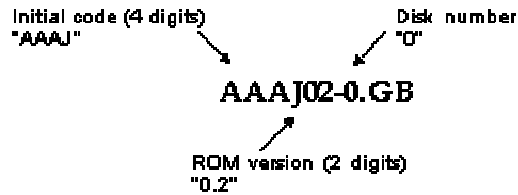

*Note:* **The first disk will be numbered "0."**

If the Initial code is 3 digits (prior to 1994), include an under bar (" \_ ") after the Initial code to bring it to 4 digits. The file name would appear as follows: "AAJ\_10-0.GB"

Enter the check sum of each ROM submitted. To calculate the check sum, add each byte in the ROM data. The lower 2 bytes of the resulting value is the check sum. Enter the check sum for each ROM submitted for the master program and the total of their individual check sums. The total is calculated by adding the individual check sums. This method of calculation is different from the check sum on the ROM Registration Specification.

17. Programming Features

Indicate if special programming is implemented for a specific purpose, such as copy protection. If special programming is implemented, it must be explained in writing.

If the software is N64 GB Pak compatible, indicate the name of the N64 game and its product code. (N64 GB Pak is a peripheral device that allows the N64 system to read data from and write to a standard Game Boy Game Pak. This device is not marketed in the U.S. For more information, please contact Nintendo Technical Support.)

18. SGB Support

If the software is designed to use Super Game Boy (SGB) functions, check "Yes." If the software is not specifically designed to use Super Game Boy functions, but will run on SGB, indicate "No."

If you checked "Yes" for SGB Support, the SGB Function Code (address 0146H) should contain "03H". If you checked "No", the data contained in address 0146H should read "00H".

Also, if you checked "Yes" for CGB Support, complete the following 3 items. Do not make any marks in these boxes if you checked "No".

a. SGB Support Marking

Check "Yes", if the SGB compatibility marking needs to be displayed on product packaging. Otherwise, check "No".

b. SGB Competition Mode

Indicate whether the game contains a multi-player function for SGB, by checking the appropriate box.

c. Program Transfer to Super NES

Indicate whether or not the program is transferred to the S-CPU for execution as a unique program on the Super NES.

**10. CHARACTER CODE LIST FOR GAME TITLE REGISTRATION**

	00	10	20	30	40	50	60	70	80	~	F0
0			SP	0	@	P					
1			!	1	A	Q					
2			"	2	B	R					
3			#	3	C	S					
4			\$	4	D	T					
5			%	5	E	U					
6			&	6	F	V					
7			'	7	G	W					
8			(	8	H	X					
9			)	9	I	Y					
A			*	:	J	Z					
B			+	;	K	[					
C			,	<	L	¥					
D			-	=	M	]					
E			.	>	N	^					
F			/	?	O	_					

Note 1: Do not use characters in shaded areas.

Note 2: "SP" means space.

Example: If ASCII character is A, ASCII code is 41.

## 11. ROM REGISTRATION DATA SPECIFICATION

Enter information regarding the game title and Game Boy software specifications at the indicated addresses in ROM.

The ROM registration data address is 80 bytes of CPU memory (0100H ~ 014FH).

ROM registration data is stored using the following format.

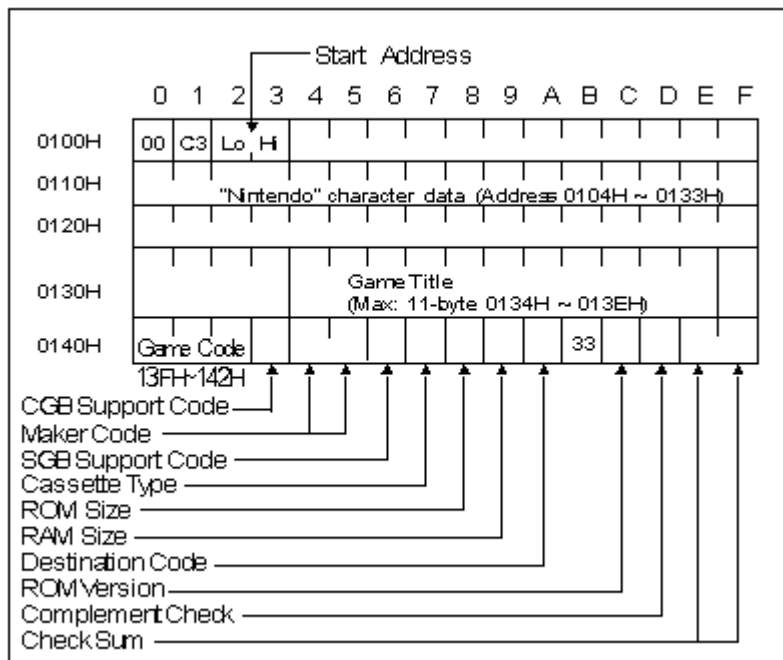

**Note** The following data will be stored in Game Boy Memory for all Game Boy software.

- 0100H = 00H
- 0101H = C3H
- 014BH = 33H
- 0104H~0133H = "Nintendo" character data



### 11.1 Description of ROM Registration Data

1. Start Address (0102H, 0103H)  
The Game Boy (Super Game Boy) program starts after Initial Program Load (IPL) is run on the CPU. The low byte of the starting address is stored first, then the high byte.
2. "Nintendo" Character Data (0104H~0133H)  
Register the character pattern of "Nintendo" to be displayed when the Game Boy is turned on. The following hexadecimal data must be store since IPL verifies it when the program begins.
3. Game Title (0134H~013EH)  
Store the game title (up to 11 characters) using ASCII code. The table "Character Code List for Game Title Registration" is provided for your convenience. Use code 20H for a space and code 00H for all unused areas in the game title. Please use only those characters listed in the provided table when registering a game title. The game title registered should be close to the title under which the game will be marketed. Please do not register a tentative name which is used for development.
4. Game Code (013FH~0142H)  
Store the 4 character game code, assigned by Nintendo, using ASCII code from the table used in item 3. Please use only "upper case" letters, listed in the provided table, when registering a game code.

Example:

When the Game Code is "APCJ", the following codes would be stored.

41H('A') → Address 013FH

50H('P') → Address 0140H

43H('C') → Address 0141H

4AH('J') → Address 0142H

This requirement only applies to new titles. If the program is changed and a master ROM resubmitted for a game title which has already been marketed, it is not necessary to insert a game code for this submission. (If the Game Code is added to an existing game, please be aware of potential problems with software verification routines in serial communication protocols or GB Pak routines. For example, the Game Titles for the old version and the new version MAY be different, causing the new version to be unrecognized by the software verification routine.)

5. CGB Support Code (0143H)

Store the code which distinguishes between games that are CGB (Game Boy Color) compatible, and those that are not.

Address 143H	Denotation
00H	CGB Incompatible
80H	CGB Compatible
C0H	CGB Exclusive

CGB Incompatible: A program which does not use CGB functions, but operates with both CGB and DMG (Monochrome).

CGB Compatible: A program which uses CGB functions, and operates with both CGB and DMG.

CGB Exclusive: A program which uses CGB functions, but will only operate on a Game Boy Color unit (not on DMG/MGB). If a user attempts to play this software on Game Boy, a screen must be displayed telling the user that the game must be played on Game Boy Color.

6. Maker Code (0144H, 0145H)

Enter the 2-digit ASCII code assigned by Nintendo. Contact Product Testing, if in doubt. All letters must be in upper case. For example;

If Maker Code is 01, the ASCII code for 0 (30H) is stored at 0144H and the ASCII code for 1 (31H) is stored at 0145H.

If Maker Code is FF, the ASCII code for F (46H) is stored at 0144H and 0145H.

7. SGB Support Code (0146H)

Store the Function Code for the game program. Use the table below.

0146H	Super Game Boy Function
00H	Game Boy (will also run on Super Game Boy)
03H	Uses Super Game Boy Functions

**Note** *In order to use Super Game Boy functions, the following data must be registered.*

0146H = 03H and 014BH = 33H

8. Cartridge Type (0147H)

Store the appropriate code for the type of cartridge (Game Pak parts configuration) being used.

Address 0147H	Parts Configuration								
	ROM	MBC-1	MBC-2	MBC-3		MBC5		SRAM	Backup Battery
				W/ RTC	No RTC	No Rumble	W/ Rumble		
00H	X								
01H	X	X							
02H	X	X						X	
03H	X	X						X	X
04H									
05H	X		X						
06H	X		X						X
07H									
08H	X							X	
09H	X							X	X
0FH	X			X					X
10H	X			X				X	X
11H	X				X				
12H	X				X			X	
13H	X				X			X	X
19H	X					X			
1AH	X					X		X	
1BH	X					X		X	X
19H	X						X		
1AH	X						X	X	
1BH	X						X	X	X

9. ROM Size (0148H)

Store the code for the program ROM size from the table below.

<b>0148H</b>	<b>ROM Size</b>
00H	256 KBit
01H	512 KBit
02H	1 MBit
03H	2 MBit
04H	4 MBit
05H	8 MBit
06H	16 MBit
07H	32 Mbit
08H	64 Mbit

10. External RAM Size (0149H)

Store the code for the size of external RAM installed in the cartridge.

<b>Address 149</b>	<b>RAM Size</b>
00H	No RAM or MBC2
01H	-----
02H	64 KBit
03H	256 KBit
04H	1 Mbit

11. Destination Code (014AH)

Store the code from the table below which indicates where the product will be marketed.

<b>Address 147</b>	<b>Destination</b>
00H	Japan
01H	All Others

12. Mask ROM Version N0. (014CH)

The mask ROM version number starts from 00 and increases by 1 for each revised version sent after starting production.

13. Complement Check (014DH)

After all the registration data has been entered (0134H~014CH), add 19H to the sum of the data stored at addresses 0134H through 014CH and store the complement value of the resulting sum.

$$(0134H) + (0135H) + \dots + (014CH) + 19H + (014DH) = 00H$$

14. Check Sum Hi and Lo

The check sum, excluding the value of 014EH and 014FH, is stored here.

Check sum Hi and Lo will be different from the Total Check Sum.

014EH = Upper

014FH = Lower

## 12. STORING DATA TO THE FLOPPY DISK

1. Use MS-DOS® 3.5 inch, 2HD disk(s).
2. The data must be submitted in binary (ROM) format. Do not compress the data. The maximum amount of data stored on each floppy should be 8Mbit.
3. The file name should be formatted as described in item #16 of "Instructions for Game Boy Software Specification Sheet - File Name and Check Sums."
4. Place a label describing the content of each disk as shown below.

Company name: Nintendo Co., Ltd.

Product name: Mario's Pikurosu

Product code: DMG-P-APCJ (JPN)

File name: APCJ00-0.GB

Check sum: ABCD

Date: 1998/8/1

### 13. PRODUCTION SOFTWARE SELECTION

MBC	ROM SIZE	256K	512K	1M	2M	4M	8M	16 M	32 M	64M	Comments
	SRAM SIZE										
None	None	○									
	64K	▲									With or without backup battery
MBC-1	None		○	○	○	○	○ <sup>*1</sup>	▲ <sup>*1</sup>			
	64K		○	○	○	○	○ <sup>*1</sup>	○ <sup>*1</sup>			With or without backup battery
	256K	▲	○	○	○	○					With or without backup battery
MBC-2	None	▲	○	○	○						With backup battery only
MBC-3 W/RTC	None	▲	▲	▲	▲	▲	▲	▲			With backup battery only
	64K	▲	○	○	○	○	○	▲			With backup battery only
	256K	▲	▲	▲	▲	▲	○	▲			With backup battery only
MBC-5	None		(▲)*2	(▲)*2	○	○	○	○	○	(○)	
	64K		(▲)*2	(▲)*2	○	○	○	○	○	(○)	With or without backup battery
	256K	(▲)*2	(▲)*2	(▲)*2	○	○	○	○	○	(○)	With or without backup battery
	1M	(▲)*2	(▲)*2	(▲)*2	▲	▲	▲	▲	▲	(▲)	With or without backup battery
MBC-5/ Rumble	None	(▲)*2	(▲)*2	(▲)*2	▲	○	○	▲	▲	(▲)	
	64K	(▲)*2	(▲)*2	(▲)*2	▲	○	○	○	○	(○)	With or without backup battery
	256K	(▲)*2	(▲)*2	(▲)*2	▲	○	○	▲	▲	(▲)	With or without backup battery

○ : Board Available  
 If a price quote is necessary, please submit a "Game Boy Price Quote Request Form" to NOA Licensing Dept.

▲ : Board Not Available  
 If required, please submit a "Game Boy Price Quote Request Form" to NOA Licensing Dept., approximately 5 months before scheduled software submission.

( ) : At the present time, a mask ROM cannot be prepared. If necessary, please contact NOA Licensing Dept.

[Notes] MBC-1, 2, and 3 do not support Game Boy Color double-speed mode (including H-DMA and General Purpose DMA. Please refer to your Programming Manual.

\*1 There are some restrictions in memory mapping when MBC-1 ROM Size is 8M or larger. Please refer to "Memory Controllers" in your Programming Manual.

\*2 For MBC-5 with ROM of 1M or less, a mask ROM supporting CGB double-speed mode can not be prepared. Double-speed mode is supported by ROM of 2M or larger.

### 14. DEVELOPMENT SOFTWARE SELECTION

ROM SIZE		256K	512K	1M	2M	4M	8M	16M	32M	Comments
MBC	SRAM SIZE									
None	None	1								
MBC-1	None		2	3						<ul style="list-style-type: none"> <li>Built-in 64K SRAM</li> <li>With or without backup battery</li> </ul>
	64K/None				4					
	256K/64K/None		5				6			<ul style="list-style-type: none"> <li>Built-in 256K SRAM</li> <li>With or without backup battery</li> </ul>
MBC-2	None			8						
MBC-3	256K/64K/None				9					<ul style="list-style-type: none"> <li>RTC Function</li> <li>Built-in 256K SRAM</li> <li>With or without backup battery</li> </ul>
MBC-5	1M/256K/64K/None					10				<ul style="list-style-type: none"> <li>Built-in 32M Flash ROM</li> <li>Built-in 1M SRAM</li> <li>With or without backup battery</li> </ul>
	256K/64K/None					11				<ul style="list-style-type: none"> <li>Built-in 32M Flash ROM</li> <li>Rumble Function</li> <li>Built-in 256K SRAM</li> <li>With or without backup battery</li> </ul>

	Product Names (*1)		Memory Specifications (*2)	Comments
	Board Name	Product Code		
1	DMG-256K-EPROM	E200225	EPROM : 27C256	EPROM not included
2	MBC1-512K-EPROM	E200241	EPROM : 27C512	
3	MBC1-1M to 2M-EPROM	E200233	EPROM : 27C101/27C2001 (Can use 301 type) (*3)	
4	MBC1-1M to 2M-EPROM+64K	E200530	EPROM : 27C101/27C2001/27C4001	
5	MBC1-Multichecker	E200191	EPROM : 27C256/27C512/27C101/27C301	
6	MBC1-4M to 16M-EPROM+64K	E200654	EPROM : 27C4001	
7	MBC1-1M to 4M-EPROM+256K	E200605	EPROM : 27C101/27C2001/27C4001	
8	MBC2-1M to 2M-EPROM	E200258	EPROM : 27C101/27C2001 (Can use 301 type) (*3)	
9	MBC3-4M-ROM2-256K	E201025	EPROM : 27C101/27C2001/27C4001/27C8001	

**Game Boy Programming Manual**

	Product Names (*1)		Memory Specifications (*2)	Comments
	Board Name	Product Code		
10	DMG-MBC5-32M-FLASH	E201264	Built-in 32M Flash Memory + 1MRAM	Requires DMG Falsh ROM Gang Writer or CGB Emulator
11	DMG-MBC5-32M-R-FLASH	E201272	Built-in 32M Flash Memory (with Rumble Pak) +256KRAM	

[Notes] MBC-1, 2, and 3 do not support Game Boy Color double-speed mode (including H-DMA and General Purpose DMA. Please refer to your Programming Manual. There are some restrictions in memory mapping when MBC-1 ROM size is 1M or larger. Please refer to "Memory Controllers" in your Programming Manual.

- \*1 : When ordering, please indicate both the board name and product code to NOA Licensing Dept.
- \*2 : For the EPROM specification, please use the described specification, above, or something with the same pin configuration.
- \*3 : Can support both types for land switching on the board.



## **15. GAME CONTENT GUIDELINES**

The following Game Content Guidelines are presented for assistance in the development of authorized game paks (i.e., both Nintendo and licensee game paks) by defining the types of themes inconsistent with Nintendo's corporate philosophy. Exceptions may be made when an objectional item is necessary to maintain the integrity of the product or the games' theme. Nintendo will only approve products (i.e., audio-visual work, packaging and instruction manuals) which do not:

- contain sexually explicit content including but not limited to nudity, rape, sexual intercourse and sexual touching; for instance, Nintendo does not allow bare-breasted women in its games, however, mild displays of affection such as kissing or hugging are acceptable.
- contain language or depictions which specifically denigrate members of any race, gender, ethnicity, religion or political group.
- depict gratuitous or excessive blood or violence. Nintendo does not permit depictions of animal cruelty or torture.
- depict verbal or physical spousal or child abuse.
- permit racial, gender, ethnic, religious or political stereotypes; for example religious symbols such as crosses will be acceptable when fitting into the theme of the game and not promoting a specific religious denomination.
- use profanity, obscenity or incorporate language or gestures that are offensive by prevailing public standard and tastes.
- promote the use of illegal drugs, smoking materials, tobacco and/or alcohol; for example Nintendo does not allow an unnecessary beer or cigarette advertisement anywhere in a product, however Sherlock Holmes smoking a pipe would be acceptable as it fits the theme of the game.

## 16. GAME BOY PRICE QUOTE REQUEST FORM

Please FAX this form to Nintendo of America Inc., Attn.: Juana Tingdale, Licensing Department, (206) 861-2173.

Today's Date (M/D/Y)	/ /	Licensee	
Release Date(M/D/Y)	/ /	Game Title	
Quantity		Contact	
<b>Specification</b>		Telephone No.	
<ROM> _____ Bit <RAM> _____ Bit/no RAM <Backup> Yes/ No			
<MBC> <u>MBC - _____</u>			
Others: Please specify if you are inquiring other than standard specification.			

This area will be completed by Nintendo:

	Signature	Date
Received by NOA Engineering	_____	_____
Received by NCL Licensing	_____	_____
Received by NCL Engineering	_____	_____
Received by NCL R & D	_____	_____

Estimated Completion Date(M/D/Y)	/ /	Resource	
Comments: EPROM PCB development, etc.			

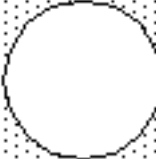
  
 NCL Licensing

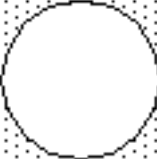
  
 NCL Engineering

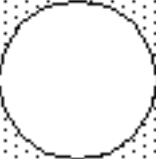
  
 NCL R & D

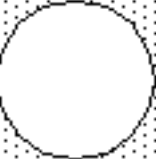
  
 Resource

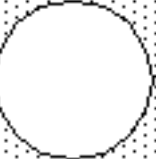
  
 Checked

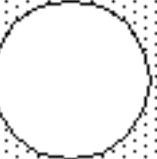
  
 Checked

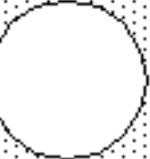
  
 Approved