

Write RAM on PH2 clock

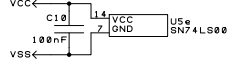

Reset circuit

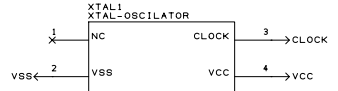
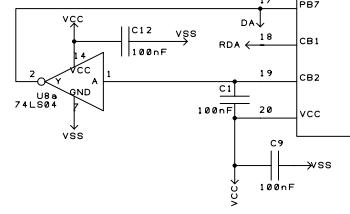
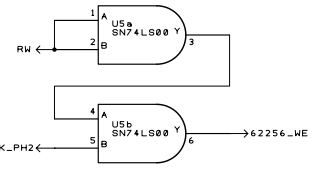
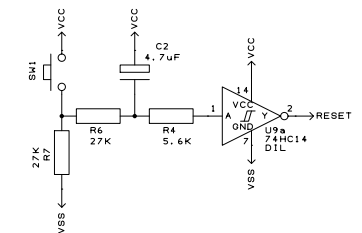

Address decoding (Select ROM for \$E000 and \$F000, PIA for \$D000)

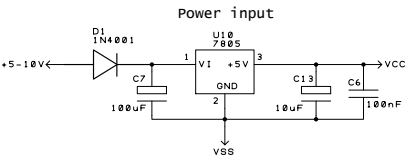
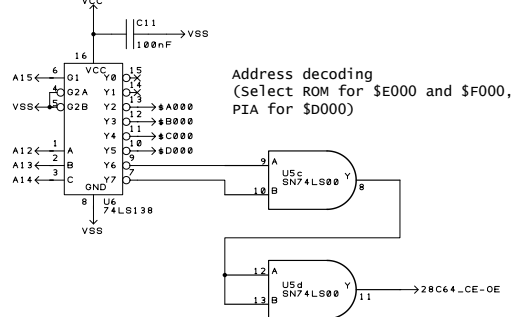

**Apple 1 Replica**

Revision 1  
 Last updated on July 18th 2017

Ruud van Falier