

Sheet: Docs  
File: Docs.sch

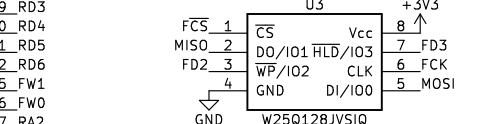

<b>Garrett's Workshop</b>	
Sheet: /	
File: GR8RAM.sch	
<b>Title: GR8RAM</b>	
Size: USLetter	Date: 2021-04-20
KiCad E.D.A. kicad (5.1.5-0-10_14)	Rev: 1.9
	Id: 1/2

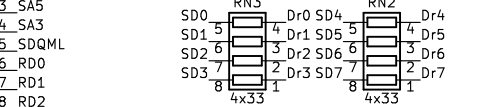
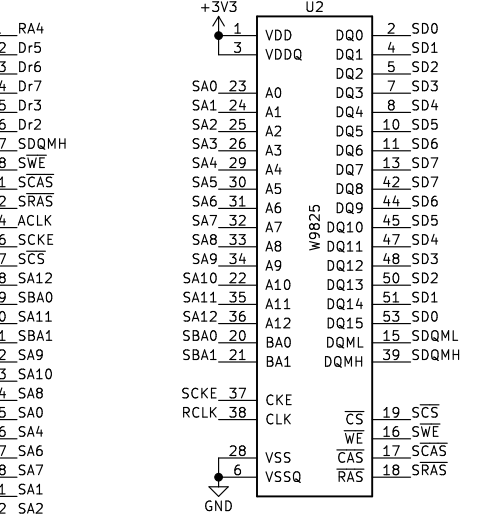
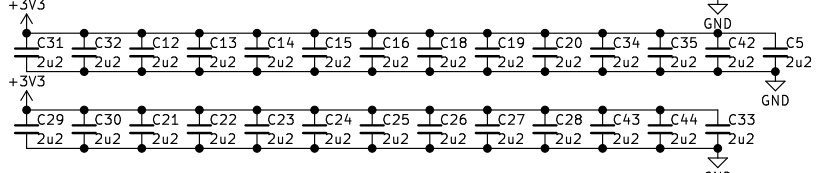
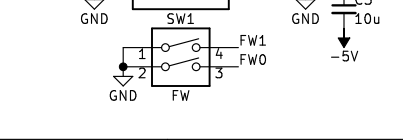
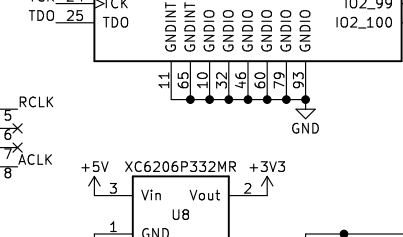
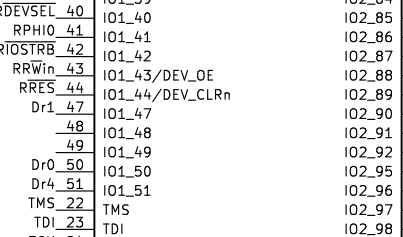
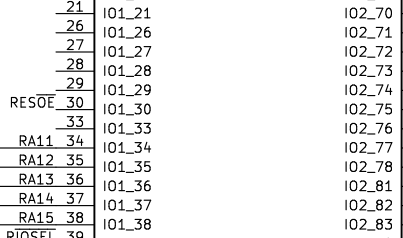
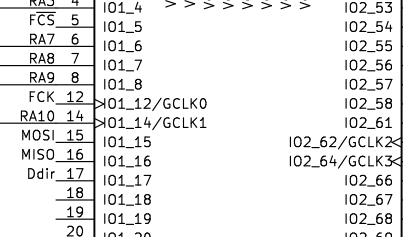
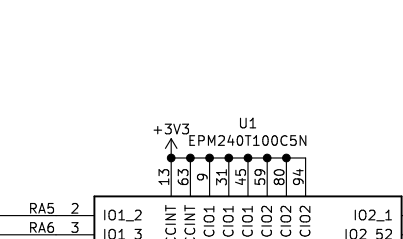
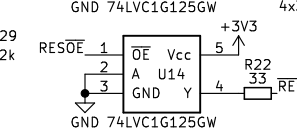
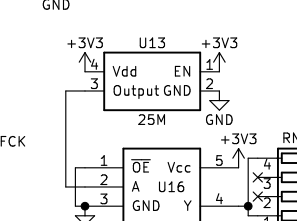
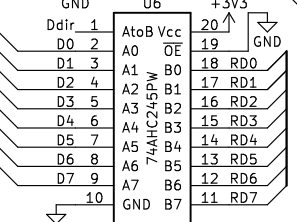
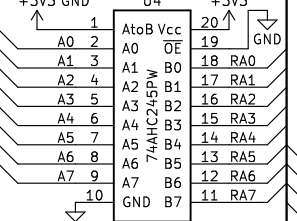
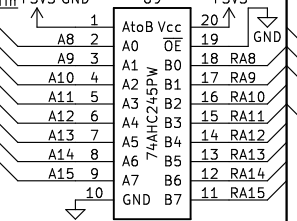
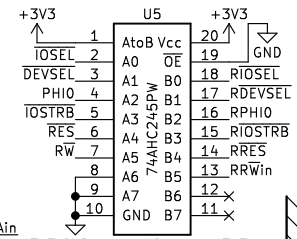
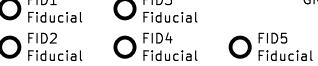
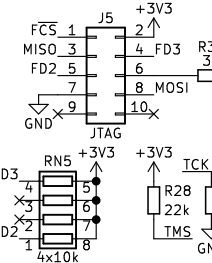
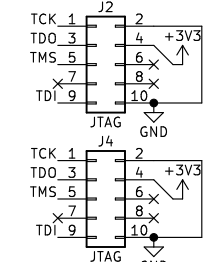
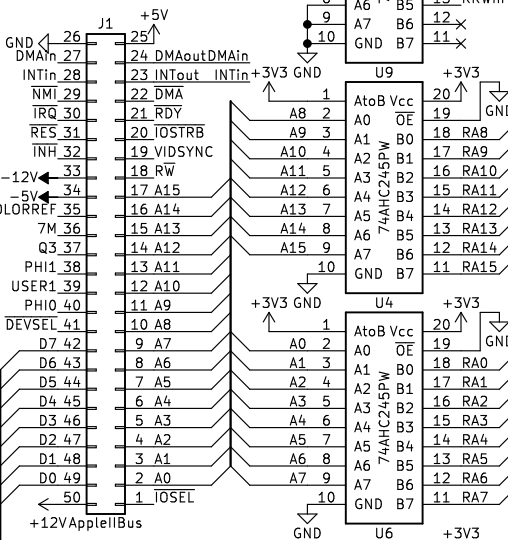
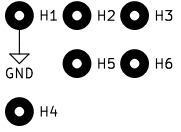
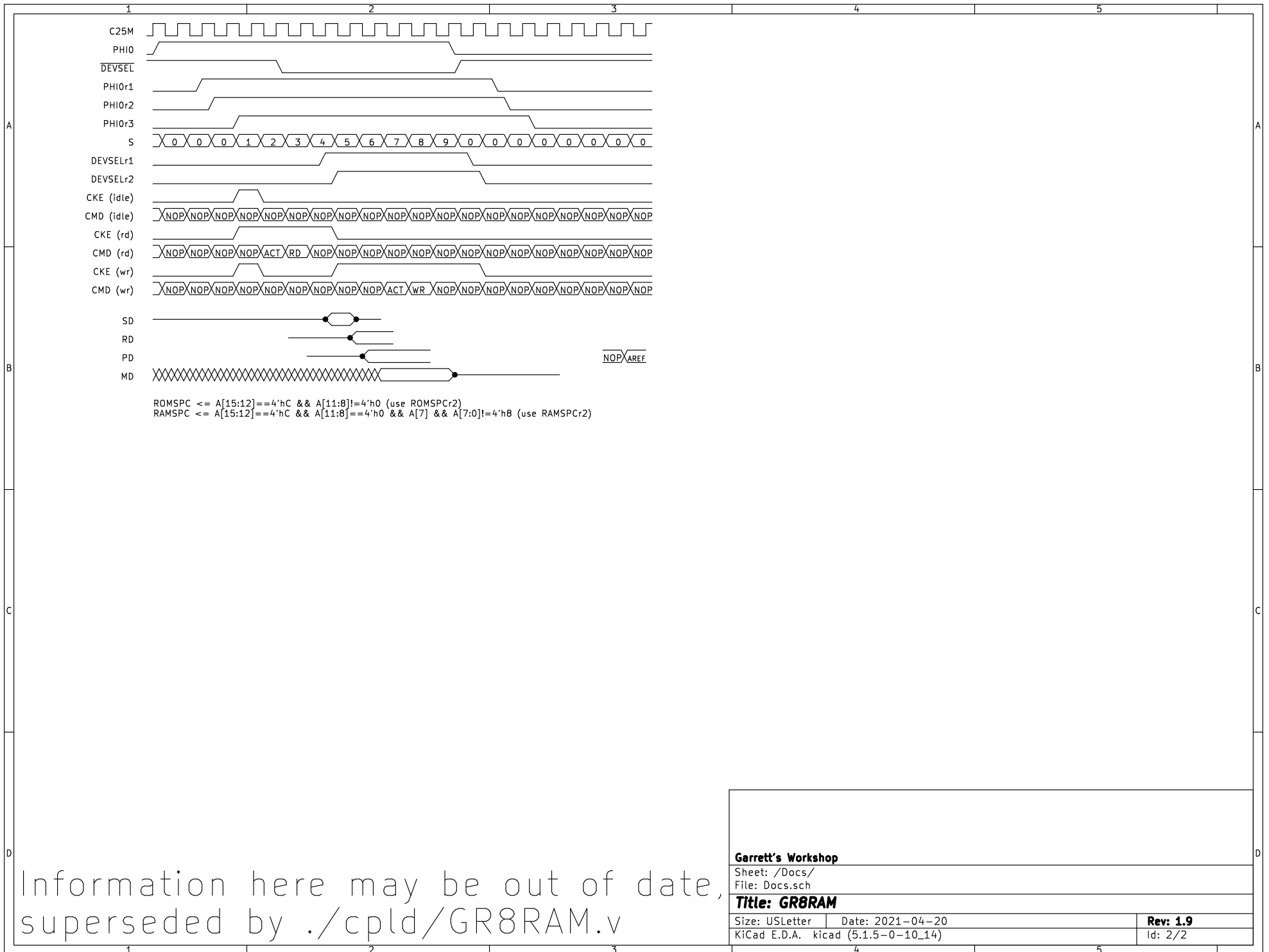

Information here may be out of date,  
superseded by ./cpld/GR8RAM.v

<b>Garrett's Workshop</b>	
Sheet: /Docs/ File: Docs.sch	
<b>Title: GR8RAM</b>	
Size: USLetter	Date: 2021-04-20
KiCad E.D.A. kicad (5.1.5-0-10_14)	<b>Rev: 1.9</b> Id: 2/2