

Garrett's Workshop

GW4402B

8 MB ROM SIMM for Macintosh SE/30 and Macintosh II-series

User's Guide

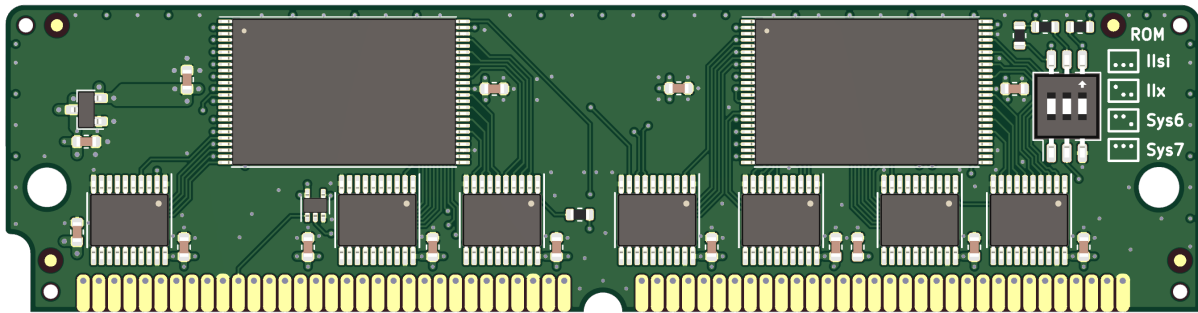

Overview

The GW4402B 64-pin ROM SIMM replaces the ROM SIMM of a Macintosh II-series or Macintosh SE/30 computer. GW4402B comes preprogrammed with several ROM images including a customized, 32-bit clean Macintosh ROM. The customized ROM allows your Macintosh to use more than 8 MB of RAM, disables RAM test for faster booting, and has a bootable ROM disk. Using a switch on the ROM SIMM, either a System 7.1 or a System 6 ROM disk image can be chosen. Both disk images are loaded with various utilities. The ROM disk can also be mounted when booting from another volume. In addition to the customized ROM, unmodified Mac IIcx and IIsi ROMs are also pre-programmed on the SIMM and can be selected using the ROM select switch.

Compatibility

GW4402B and its ROM disk are compatible with the following Macintosh computers:

- Macintosh IIx
- Macintosh IIcx
- Macintosh IIci
- Macintosh IIfx
- Macintosh IIsi
- Macintosh SE/30

Except for accelerators, all hardware and software we have tested is compatible with the SIMM's custom ROM. Generally, accelerators with MC68030 processors are fully working, but some accelerators with MC68040 processors are incompatible. In case of incompatibility with the custom ROM, the Mac IIsi and Mac IIcx ROMs can be selected using a switch on the SIMM.

Multiple ROM and Disk Images

The GW4402B ROM SIMM has four preprogrammed ROM images selectable via switch:

- Customized ROM with System 7.1.1 ROM disk and RAM test disabled (compatible with all supported Macintosh computers and based on Mac IIsi ROM)
- Customized ROM with System 6.0.8 ROM disk and RAM test disabled (compatible with all supported Macintosh computers and based on Mac IIsi ROM)
- Unmodified Macintosh IIsi ROM (compatible with all supported Macintosh computers)
- Unmodified Macintosh IIx ROM (only compatible with Macintosh IIx, IIcx, and SE/30)

ROM images can be rewritten using a ROM SIMM programmer such as the CayMac ROMmate.

Fast Startup

It takes about 10 seconds to boot from the included ROM-based System 7.1, so you can begin working with programs or playing games almost instantly. The System 6 ROM disk image boots even more quickly.

ROM Disk Settings Control Panel

A control panel allows your preferences for the built-in ROM disk to be changed. You can boot from the ROM disk, mount it under another boot disk, or hide it from the desktop completely. Of course, you can always press "R" during startup to boot from ROM independent of your saved preferences.

It's also possible to enable RAM disk mode, which allows writing data to the ROM disk, although data stored is not retained between restarts. The RAM disk is enabled by pressing "A" during startup, or by enabling the corresponding setting in the control panel.

Ecologically Friendly, Gold-Plated PCB

GW4402B features a lead-free, ENIG gold-plated, 4-layer PCB and is fully EU RoHS-compliant. All units are tested extensively before shipment. Only new parts are used to build GW4402B, and all GW4402B ROM SIMM modules are manufactured in our semi-automated facility in Columbus, Ohio, in the United States.

Open-Source Design

GW4402B's design is fully open-source. The schematics, board layouts, and driver software are all freely available for commercial and noncommercial use. To download the design files, visit the Garrett's Workshop GitHub page: <https://github.com/garrettsworkshop>

ROM Select Switches

The “ROM Select” DIP switch allows you to select between several ROMs flashed on the SIMM. The GW4402B ROM SIMM is preprogrammed with the following four ROM images:

- “Sys7” - Custom ROM with System 7.1.1 ROM disk and RAM test disabled (compatible with all supported Macintosh computers and based on Mac IIsi ROM)
- “Sys6” - Custom ROM with System 6.0.8 ROM disk and RAM test disabled (compatible with all supported Macintosh computers and based on Mac IIsi ROM)
- “IIsi” - Unmodified Macintosh IIsi ROM (compatible with all supported Macintosh computers)
- “IIx” - Unmodified Macintosh IIx ROM (only compatible with Macintosh IIx, IIcx, and SE/30)

The Macintosh IIsi ROM is compatible with all above Macintosh models. The Macintosh IIx ROM is the stock ROM found on the Macintosh IIx, IIcx, and SE/30 and is only compatible with these machines.

Installation

The GW4402B ROM SIMM must be installed into the ROM SIMM slot on your Macintosh’s motherboard. Before installing the SIMM, make sure to set the ROM select switches on the right side of the SIMM board.

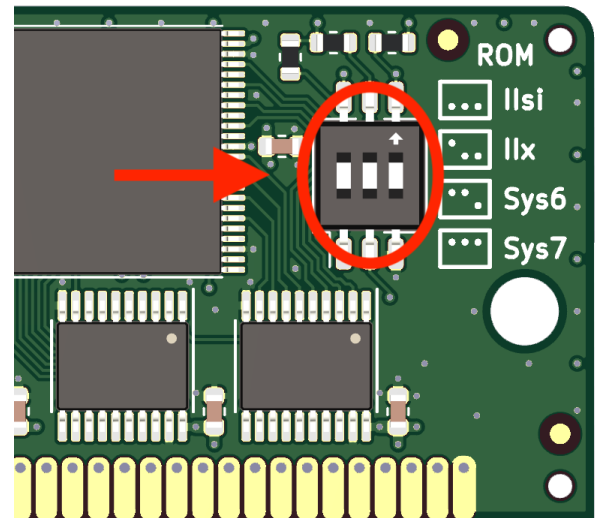

On Macintosh II-series machines, the ROM SIMM socket is accessible by just removing the computer’s top cover. On Macintosh SE/30 machines, the computer must be disassembled and the motherboard removed in order to install the SIMM. Depending on your machine, a jumper may need to be installed or removed to enable the ROM disk.

See below for installation instructions for each supported machine:

[Installation Procedure for Macintosh SE/30](#)

To install the GW4402B ROM SIMM in a Macintosh SE/30 computer, disassemble the computer and remove the motherboard. On the motherboard, locate the ROM SIMM socket. Remove the existing ROM SIMM if one is installed, replace it with the new SIMM, then reassemble the computer.

[Installation Procedure for Macintosh IIcx and IIsi](#)

To install the GW4402B ROM SIMM in a Macintosh IIcx or Macintosh IIsi computer, open the machine’s top cover and locate the ROM SIMM socket as well as the jumper labeled “W1.” **Remove** the “W1” jumper, install the ROM SIMM in the ROM SIMM socket, replacing any ROM SIMM already in the socket, then reassemble the computer.

[Installation Procedure for Macintosh IIsi](#)

To install the GW4402B ROM SIMM in a Macintosh IIsi computer, open the machine’s top cover and locate the ROM SIMM socket as well as the jumper labeled “W1.” **Install** the “W1” jumper, install the ROM SIMM in the ROM SIMM socket, replacing any ROM SIMM already in the socket, then reassemble the computer.

Installation Procedure for Macintosh IIx and IIcx

To install the GW4402B ROM SIMM in a Macintosh IIx or Macintosh IIcx computer, open the machine's top cover and locate the ROM SIMM socket. Remove the existing ROM SIMM if one is installed, replace it with the new SIMM, then reassemble the computer.

Reinforcing Clips for ROM SIMM Sockets

Many Macintosh models made before 1991 use a ROM SIMM socket with plastic retaining clips. Over time, these clips tend to weaken and may no longer hold a ROM SIMM in proper contact with the contact pins in the socket. To address this problem, plastic reinforcing clips are included with the ROM SIMM. These fit over the sides of the ROM SIMM socket and brace the SIMM, ensuring good electrical contact. Later Macintosh models have a ROM SIMM socket with metal clips and do not require any extra reinforcement. If your Macintosh's ROM SIMM socket has metal clips on the sides, you do not need to install the reinforcing clips. However, if your Macintosh's ROM SIMM socket has plastic clips on the sides, we recommend installing the reinforcing clips.

Two sets of two clips are included with the ROM SIMM, corresponding to the two types of ROM SIMM socket with plastic clips used on Macintosh II-series and SE/30 motherboards. Before installing the reinforcing clips, you must determine the type of ROM SIMM socket used on your Macintosh.

Some sockets have a flat edge:

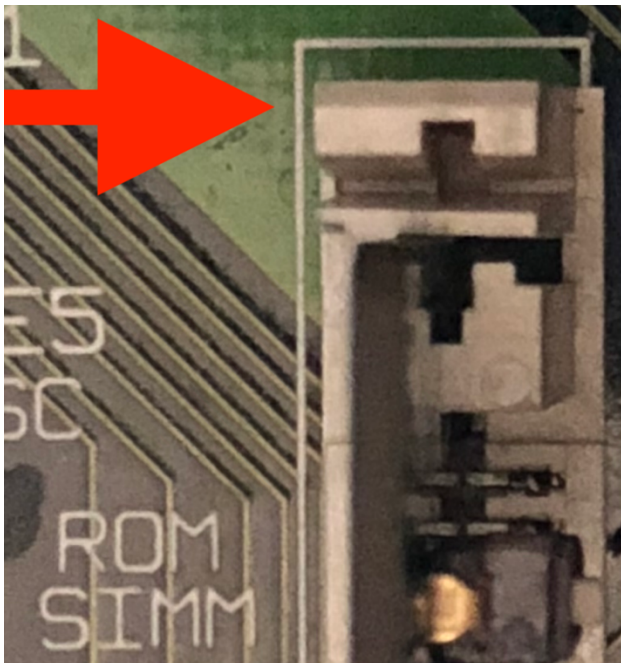

Other sockets have a cross-shaped edge:

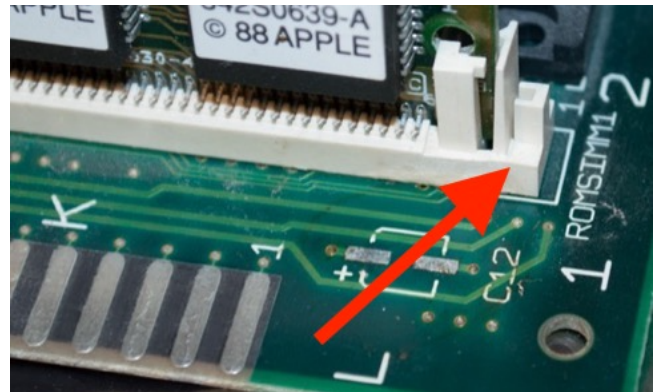

After identifying the type of ROM socket in your machine using the pictures above, select the correct set of reinforcing clips. If your ROM SIMM socket has metal tabs, you do not need to install the reinforcing clips. After installing the ROM SIMM itself into the socket, slide the correct type of clip over the edge of the ROM SIMM socket. First you may have to angle the reinforcing clip onto the side of the socket like so:

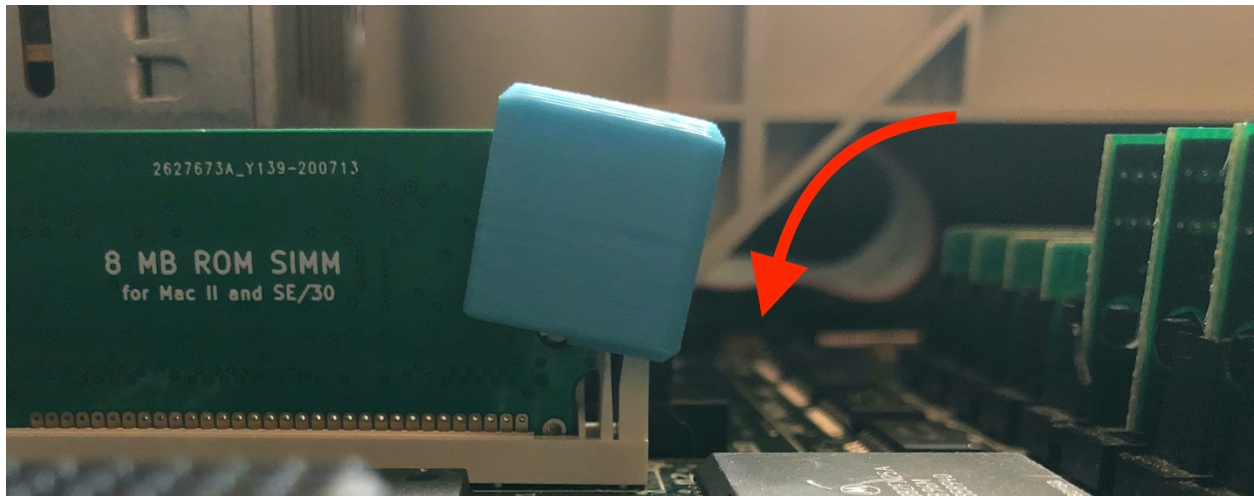

Then push down to slide the clip downward until the clip is fully seated on the SIMM socket:

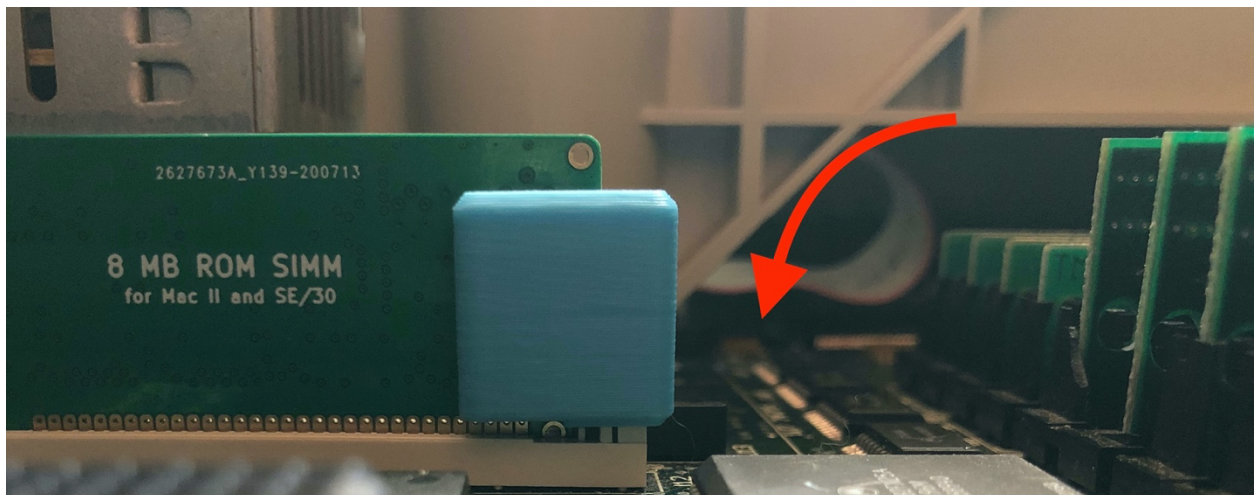

ROM Fitment Stickers

In case the plastic reinforcing clips are not sufficient to ensure the ROM SIMM makes good contact with the socket, “fitment stickers” are included with each ROM SIMM. These thicken the SIMM boards slightly where it contacts the retaining clips, helping the socket put more pressure on the pins at the bottom of the SIMM and promoting good electrical contact.

Adhering the Fitment Stickers

When applying the stickers, line the hole on the sticker up with the hole on the side of the SIMM. At the same time, press your finger against the left/right edge of the SIMM to align the sticker with the SIMM edge and prevent it from running off the edge of the SIMM. Once the sticker is in the correct place, press firmly with your thumb in order to strongly affix it to the SIMM board. Extra stickers are always included in case of a mistake applying the sticker.



Booting from the ROM Disk

To boot from the ROM disk, ensure the “ROM Select” DIP switch is set to the upper position and press “R” repeatedly while powering up the Macintosh, until the “Welcome to Macintosh” screen appears. If you require a writable boot disk, for example to use AppleTalk, you can repeatedly press “A” instead and the system will boot from ROM but copy the contents of the ROM disk into RAM. The RAM disk function allows the boot volume to be modified temporarily but requires at least 16 MB of RAM memory.

Mounting the ROM Disk

By default, when booting from a volume other than the ROM disk, the ROM disk volume is mounted on the desktop as would be any other drive. This functionality can be disabled using the GW ROM Disk control panel.

Changing Default Settings Using the GW ROM Disk Control Panel

The GW ROM Disk control panel allows various ROM disk settings to be changed. Settings are stored in PRAM and can be reset by “zapping” the PRAM at boot using the Cmd+Opt+P+R key combination.

The control panel allows selection of the default boot settings, including whether the machine should always boot from ROM rather than an internal SCSI disk. It’s also possible to enable or disable mounting of the ROM disk volume under another boot disk. The control panel also allows MacsBug and the Apple CD-ROM extension to be enabled and disabled.

Pressing “R” or “A” to boot from ROM disk always overrides the defaults set in the control panel and causes MacsBug and Apple CD-ROM to be disabled.

MacsBug requires 32 MB RAM when enabled in conjunction with the RAM disk. CD-ROM support slows booting substantially when a CD-ROM drive is not present and should be disabled unless a CD-ROM drive is installed.

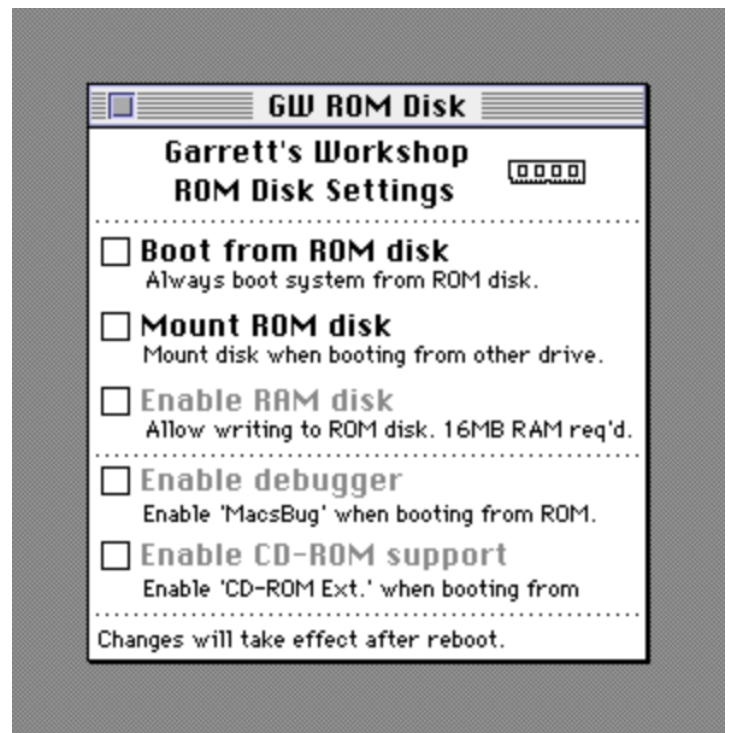

Updating the ROM Image (for advanced users)

The GW4402B ROM SIMM can be flashed using a ROM SIMM programmer. Supported programmers include:

- dougg3 ROM SIMM Programmer
- Big Mess o' Wires ROM SIMM Programmer
- CayMac ROMmate Programmer (v1 and v2)

All three supported programmers use the same programmer software.

Programmer Firmware Update

Ensure your ROM SIMM programmer software is updated to at least version 2.0 and your ROM SIMM programmer firmware is updated to firmware version 1.5.1.

ROM Size and Switch Settings – two 8 MB images

Two ROM images of up to 8 MB can be flashed to the SIMM. To do this, set the left two switches to the up position. The rightmost switch selects one of the two 8 MB images to flash. This corresponds to the “Sys6” and “Sys7” switch positions marked on the board.

ROM Size and Switch Settings – more ROM image configurations (for advanced users)

The following schematic shows the functionality of the ROM select switch:

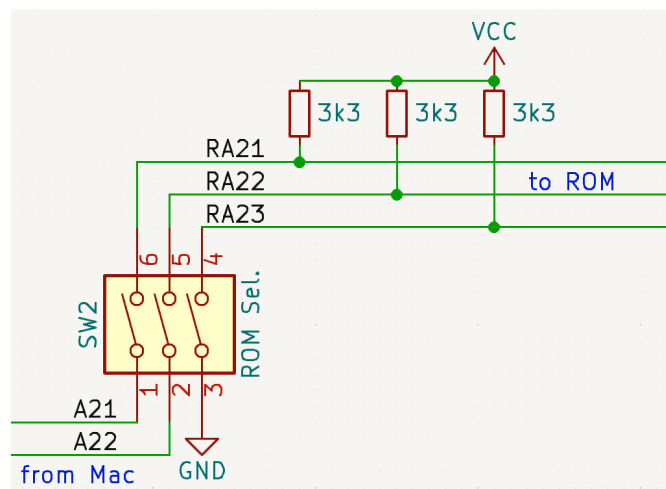

Restoring original ROM

The original ROM as shipped on the SIMM can be downloaded from our website:

<https://garrettsworkshop.com>

The ROM is provided as two files, GWSys71.bin and GWSys61IxIIsi.bin. Each file must be flashed separately. Flash the GWSys71.bin ROM file with all three ROM select switches in the up position, and the GWSys61IxIIsi.bin ROM File with the two left switches in the up position and the rightmost switch in the down position.

Creating a ROM Image (for intermediate users)

Users can create a ROM image which includes a custom ROM disk image. To create a ROM image, concatenate the ROM disk driver-equipped base ROM (available on the Garrett's Workshop website) with a disk image of up to 7.5 MB (7864320 bytes).

Adding Debugger/CD-ROM Settings to Your ROM Image (optional, for advanced users)

The base ROM contains a table which configures the debugger and CD-ROM extension patches accessible through control panel. The patching mechanism works by replacing a single byte in the disk image when the debugger and CD-ROM extensions are disabled. The idea is to change the file name or creator code of the debugger or CD-ROM extension so that it is not loaded by the Mac OS. Data contained in the table in the ROM image indicates where the ROM must be patched and what value must be substituted to use the "disable debugger" and "disable CD-ROM" features. These fields may be completed for your ROM image or left at their default values. The layout of the table is given below:

ROM Offset	Data Type (Size)	Description
0x51DA0	char* (4 bytes)	Address of 'Macsbug' / debugger name Pascal string
0x51D98	uint32 (4 bytes)	ROM disk offset at which to disable debugger
0x51DA8	char (1 byte)	Byte to patch at above offset to disable debugger
0x51DA4	char* (4 bytes)	Address of 'Apple CD-ROM Ext.' / CD-ROM ext. Pascal string
0x51D9C	uint32 (4 bytes)	ROM disk offset at which to disable CD-ROM extension
0x51DA9	char (1 byte)	Byte to patch at above offset to disable CD-ROM extension

SIMM Programmer Compatibility Notes

Due to a small defect relating to TTL compatibility in the dougg3 ROM SIMM Programmer, the Big Mess o' Wires ROM SIMM Programmer, and the CayMac ROMmate Programmer version 1, there is a small chance that after programming a ROM image to the GW4402B ROM SIMM, verification and readback of the image may fail. If this occurs, disable verification by setting the "don't verify" option and program the SIMM again. The readback error is just due to a communication issue between the GW4402B SIMM and the programmer and does not affect correct programming of the image.

A technical description of the issue with the programmers follows:

The incompatibility involves the signaling level used by the dougg3, BMoW, and CayMac ROMmate v1 programmers. All Macintosh II models use the "TTL" transistor-transistor logic standard to determine which voltage levels correspond to valid logical "0" and "1" levels. In the TTL standard, a voltage below 0.8 volts is considered to be a "0" and a voltage above 2.0 volts is considered to be a "1". Devices outputting digital data are encouraged to include an additional fraction of a volt margin to compensate for resistive loading, transmission line effects, etc. Therefore, devices conforming to the TTL standard must output 0.5 volts when driving a logical "0" and 2.4 volts when driving a logical "1".

TTL signaling levels are used in Macintosh II series computers and therefore our ROM SIMM is fully compatible with the TTL standard so that it interoperates reliably with the Macintosh II. However, the dougg3, BMoW, and CayMac ROMmate v1 programmers use the MCP23S17 I/O expander chip to communicate with the ROM SIMM. This chip as used in the programmer is not TTL compatible. Referring to the MCP23S17 datasheet, 80% of the supply voltage is required to denote a logical "1". At an operating voltage of 5.0 volts, the minimum voltage threshold for a "1" amounts to 4.0 volts. Our GW4402B ROM SIMM outputs about 3.6 volts for a logical "1", so this does not quite meet the unusually stringent requirements of these older programmers. Fortunately, this only applies to data received by the programmer from the ROM SIMM, not data sent by the programmer to the SIMM. Therefore, data is always written reliably to the SIMM but may not read back correctly in the case where the 3.6 volt output is not high enough to be considered a logical "1" by the programmer.

Technical Specifications

Physical Dimensions

Parameter	Value
Height	25.019 mm \pm 0.2 mm
Width	97.79 mm \pm 0.2 mm
Thickness	< 5 mm
Weight	< 28 g

Electrical Specifications

Specifications are valid over temperature range of 0 °C – 85 °C and $V_{CC} = 4.5 \text{ V} - 5.5 \text{ V}$.

Parameter	Value	Conditions
V_{IHmin}	2.0 V	
V_{ILmax}	0.8 V	
V_{OHmin}	2.5 V	$I_{OH} = -4 \text{ mA}$
V_{OHmin}	3.5 V	$I_{OH} = 0 \text{ mA}$
V_{OLmax}	0.5 V	$I_{OL} = 4 \text{ mA}$
I_{Imax}	$\pm 20 \mu\text{A}$	$V_{in} = 0 \text{ V} - 5.5 \text{ V}$
C_{IOmax}	20 pF	data bus D[31:0] address bus A[22:0], nCS, nOE, nWE
I_{CCmax}	80 mA	$V_{CC} = 5 \text{ V}$