

In from Apple Rev. C SCSI card

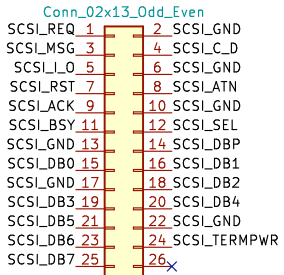

Out to DB-25 rear connector

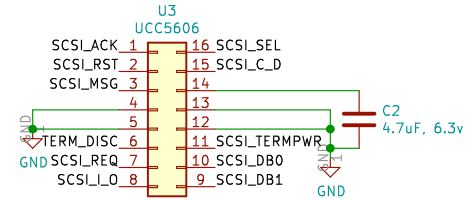
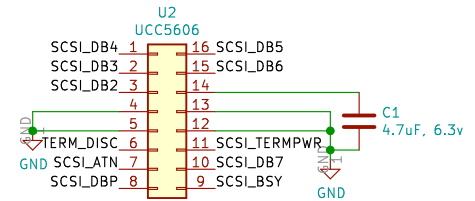
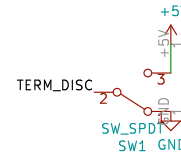
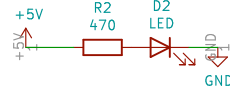
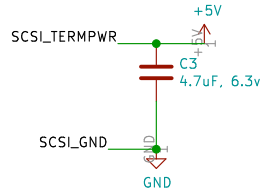
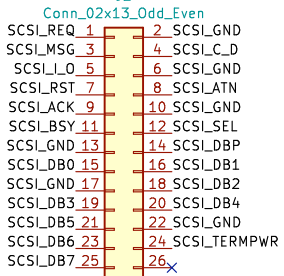

- H1 MountingHole
- H2 MountingHole

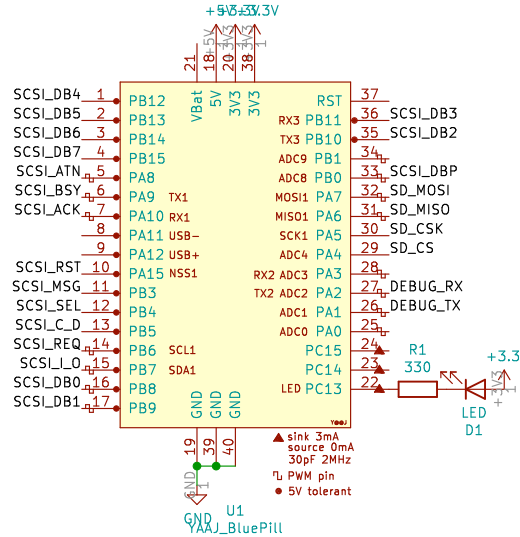

U1 BluePill

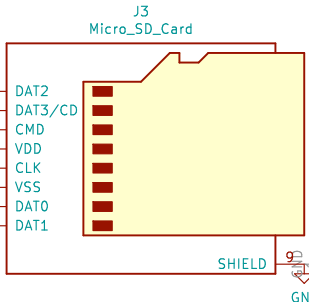
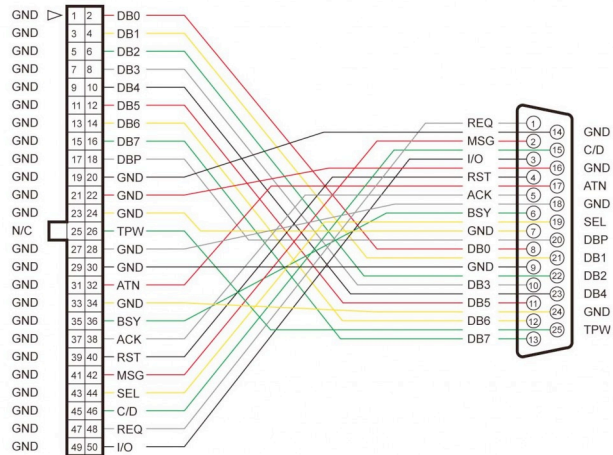
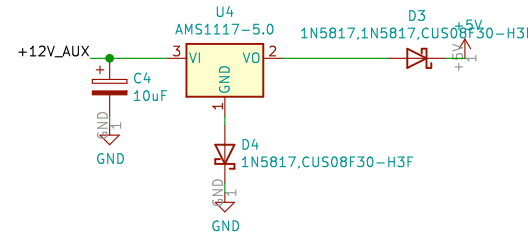

Sheet: /		Date:	
File: bluescsi_iigs_internal.sch		Rev:	
Size: A4	KiCad E.D.A. kicad (5.1.8-0-10_14)		Id: 1/1